

SNAP-ON TOOLS, Inc.

*Blue-Point, No compromise!*

LIFETIME WARRANTY



**Blue-Point®**

# History of Blue-Point



**1925**

Blue Point Tool Company was formed



**1930**

Snap-on Wrench Company and Blue Point Tool Company merged to become Snap-on Tools, Inc.



**1940**

Superior tools from Snap-on, Inc. Making headlines in the industry



**1945**













Forged Steel Products Company finally merged into Snap-on Tools, Inc.

Founded in 1925, Blue Point Tool Company was formed in Wisconsin, United States, as a tools manufacturing company. The Blue Point name was derived then from the blue-coloured tip of punches & chisels formed after oil quenching and tempering. This distinguished Blue Point's products from competitors' and Blue Point eventually became a brand synonymous with quality hand tools.

Following the successful introduction of the Blue Point punches and chisels, the management turned to their Milwaukee supplier factory to provide open end wrenches and issued this order: "Forget competition, forget price, forget precedent; just take our order to make the best wrench in the world, and we will sell them regardless of competition and regardless of price." A short time later the factory delivered their first set of eight open end wrenches and guaranteed that it was IMPOSSIBLE - to break the head; to spread the jaws; to bend the handle; to injure them; or, to destroy their everlasting efficiency. That sounded like a pretty wild and extravagant claim, but the sales force set out to sell them on that basis...and sell them they did!



# Contents

	<b>TOOL STORAGE</b>					1-7
	Roll Cabinets	Roll Carts	Tool Boxes	Roll Cab Accessories		
	<b>MASTER TOOL SETS</b>					8-19
	General Service Sets	Automotive Tool Sets	Modular Tool Sets			
	<b>SOCKETS, RATCHETS &amp; ACCESSORIES</b>					20-37
	1/4"	3/8"	1/2"	3/4"		
	<b>WRENCHES</b>					38-47
	Wrench Sets	Adjustable Wrenches	Combination Wrenches			
	Double Open End Wrenches	Offset Box Wrenches	Ratcheting Wrenches			
	L and T shape Wrenches	Other Wrenches				
	<b>SCREWDRIVERS &amp; BITS</b>					48-53
	Screwdrivers	Bits				
	<b>PLIERS</b>					54-69
	Plier Sets	Standard Pliers	VDE Pliers			
	Locking Pliers	Retaining Ring Pliers	Special Pliers			
	<b>TORQUE TOOLS</b>					70-75
	Adjustable Click-Type	Preset Click-Type				
	Electronic Type	Digital Torque Testers				
	<b>POWER TOOLS</b>					76-105
	Air Tools	Cordless Tools				
	Impact Sockets	Accessories				
	<b>STRIKING &amp; CUTTING</b>					106-115
	Hammers	Punches & Chisels	Cutting Tools			
	<b>MEASURING &amp; OTHER HAND TOOLS</b>					116-129
	Measuring Tools	Flashlights				
	Safety	Miscellaneous				
	<b>SHOP &amp; TECHNICIAN TOOLS</b>					130-157
	Testing and Electronics	Special Tools	Automotive Specialty Tools			
	<b>SHOP EQUIPMENT</b>					158-161
	Shop Equipment					



# Tool Storage





Getting organized for the job gives you more than you may have realized. You can be sure that tools you need are readily available. The work space gets less messy and you focus better. No more searching of tools all over and replacement of missing tools. Time is spent more productively and work is done more efficiently. End of the day, you feel better and you look forward to your day's work, with your tools.

Professionals have long realized that and they work with pride. And we have been providing the exact tool storage they require to make this possible. Our tool storage are designed with the latest computer-aided design systems and built to last the daily knocks of the work environment they are put into. Our paint and finishing systems deliver the finest, most durable finishes available and our rigorous testing ensures a trouble free lifetime of service.

Roll Cabinets

2

Roll Carts

3

Tool Boxes

4

Roll Cab  
Accessories

7



# Tool Storage Roll Cabinets

## 6 Drawers Roll Cab

**KRB2006KPQP**  
Order NO.: 101009



	Cubic (cm <sup>3</sup> )	Net Weight (kg)	Shipping Weight (kg)		
	156,791	75	95		
	Drawers	Width (mm)	Depth (mm)	Height (mm)	
Specifications	6	660	503	965	
Drawers	5	544	445	91	
	1	544	445	193	

Colors Available ● KRB2006KPQR ● Order NO.: 101010

- Full double walled construction making for a stronger box which resists the constant pounding of weight and vibration
- Stiffeners are added between the walls to reduce stress on the box and keep the drawers from sagging
- Welded lock tabs on the back of each drawer
- Casters are fastened to the roll cab using weld nuts so they won't loosen over time
- Drawer edges are hemmed to double thickness so they are extra stiff

## 5 Drawers Roll Cab

**KRB13005KPRB**  
Order NO.: 101005



	Cubic (cm <sup>3</sup> )	Net Weight (kg)	Shipping Weight (kg)		
	159,387	61	68		
	Drawers	Width (mm)	Depth (mm)	Height (mm)	
Specifications	5	677	501	822	
Drawers	1	543	445	54	
	2	543	445	119	
	2	543	445	184	

Colors Available ● KRB13005KPRR ● Order NO.: 101006

- High grade steel plate with PE Powder painting for better flowing property to avoid peel
- 45 kg slider with fully-openable drawers
- Bigger sized with greater capacity at 508 kg
- Tubular lock-stronger over molded key lock
- Ribs added for enhanced strength to prevent cabinet deformation

## 8 Drawers Roll Cab

**KRB13008KPRB**  
Order NO.: 101007



	Cubic (cm <sup>3</sup> )	Net Weight (kg)	Shipping Weight (kg)		
	168,059	110	129		
	Drawers	Width (mm)	Depth (mm)	Height (mm)	
Specifications	8	1016	501	961	
Drawers	5	543	445	119	
	1	543	445	250	
Cabinet Drawers	2	284	445	40	

Colors Available ● KRB13008KPRR ● Order NO.: 101008

- 40" double bank roll cab, greater capacity
- Double-wall design for a more rigid tool box
- Welded lock tabs on the back of each drawer
- Popular choice with side cabinet for your work center
- Full double walled construction making for a stronger box which resists the constant pounding of weight and vibration
- Stiffeners are added between the walls to reduce stress on the box and keep the drawers from sagging

## 6 Drawers Roll Cab

**KRB13006KPRB**  
Order NO.: 101003



	Cubic (cm <sup>3</sup> )	Net Weight (kg)	Shipping Weight (kg)		
	156,536	65	72		
	Drawers	Width (mm)	Depth (mm)	Height (mm)	
Specifications	6	677	501	822	
Drawers	3	543	445	54	
	2	543	445	119	
	1	543	445	250	

Colors Available ● KRB13006KPRR ● Order NO.: 101004

- High grade steel plate with PE Powder painting for better flowing property to avoid peel
- 45 kg slider with fully-openable drawers
- Bigger sized with greater capacity at 508 kg
- Tubular lock-stronger over molded key lock
- Ribs added for enhanced strength to prevent cabinet deformation

## 8 Drawers Roll Cab

**1**  Drawers made using 20 AWG steel

**2**  Lock & Roll mechanism to prevent drawers from sliding open

**3**  Railings withstanding 45kg per rail with roller bearings for smoother sliding of drawers

**3**  Drawer edges are hemmed to double thickness to be extra stiff



**4**  Cabinet door edges are folded to form a seamless fit without gaps when closed; Cabinets walls reinforced with stiffeners to provide extra strength

**5**  Reinforced base design to withstand higher overall load and reduce sagging

**6**  Large 5" castor wheels are bolt fastened for better rolling and durability

# Tool Storage Roll Cabinets / Roll Carts



## 7 Drawers Roll Cab

KRB13007KPRB  
Order NO.: 101001



	Cubic (cm <sup>3</sup> )	Net Weight (kg)	Shipping Weight (kg)	
	153,695	68	75	
	Drawers	Width (mm)	Depth (mm)	Height (mm)
Specifications	7	677	501	822
Drawers	5	543	445	54
	1	543	445	119
	1	543	445	250

Colors Available ● KRB13007KPRR ● Order NO.: 101002

- High grade steel plate with PE Powder painting for better flowing property to avoid peel
- 45 kg slider with fully-openable drawers
- Bigger sized with greater capacity at 508 kg
- Tubular lock-stronger over molded key lock
- Ribs added for enhanced strength to prevent cabinet deformation

## 1 Drawer Roll Cart

KRBC3TDPCM  
Order NO.: 102003



	Net Weight (kg)	Load Capacity (kg)		
	29.5	136		
	Drawers	Width (mm)	Depth (mm)	Height (mm)
Specifications	1	813	452	920
Trays	—	762	686	102
Drawer	1	368	686	102

Colors Available ● KRBC3TD ● Order NO.: 102004

- Features 4" deep locking drawer with tubular lock for added tool security
- Two sturdy, 3" deep trays are positioned for convenience
- Friction drawer slides
- Made of heavy-gauge steel

## 5 Drawers Top Chest

KRB2055KPQP  
Order NO.: 101011



	Cubic (cm <sup>3</sup> )	Net Weight (kg)	Shipping Weight (kg)	
	72,824	38	44	
	Drawers	Width (mm)	Depth (mm)	Height (mm)
Specifications	5	660	374	437
Drawers	4	566	334	47
	1	566	334	79

Colors Available ● KRB2055KPQR ● Order NO.: 101012

- Can be placed on all Blue-Point rollcabs as a top chest
- Lockable top lid
- Side grooves for easy lifting

## 4 Drawers Flip-Top

KRBC7TDPCM  
Order NO.: 102005



	Net Weight (kg)	Load Capacity (kg)		
	56.2	—		
	Drawers	Width (mm)	Depth (mm)	Height (mm)
Specifications	4	889	431	1,041
Drawers	2	350	399	51
	1	700	391	51
Bottom Shelf	1	700	391	102
	1	700	391	76

Colors Available ● KRBC7TD ● Order NO.: 102006

- Latch System to unlock all 4 drawers once the top lid has been opened with a key
- Folding side work shelf provides extra work space
- Padded lid provides an additional work surface
- Locking prybar compartment securely holds all length prybars and screwdrivers

## 2 Shelves

KRBC2TCPCM  
Order NO.: 102001



	Net Weight (kg)	Load Capacity (kg)		
	17.2	159		
	Drawers	Width (mm)	Depth (mm)	Height (mm)
Specifications	—	756	428	920
Trays	—	756	428	75

Colors Available ● KRBC2TC ● Order NO.: 102002

- This model cart offers a more rugged construction
- Cart is also slightly larger than past models
- Trays feature rolled edges for improved strength and rigidity
- Maximum load capacity 68kg per tray
- Welded post holders
- Two locking casters

## 4 Drawers Flip-Top

KRBC10TBPCM  
Order NO.: 102007



	Cubic (cm <sup>3</sup> )	Load Capacity (kg)		
	121,700	245		
	Drawers	Width (mm)	Depth (mm)	Height (mm)
Specifications	4	775	520	1,048
Drawers	2	292	445	64
	1	622	445	64
Bottom Shelf	1	622	445	64
	2	762	483	89
Top Compartment	—	762	483	64

Colors Available ● KRBC10TB ● Order NO.: 102008

- Auto locking mechanism locks drawers when lid is closed
- Plated fasteners resist corrosion and self locking nuts assure a rigid, secure assembly
- Non-toxic mats in shelf, drawers and top compartment protect unit and keep tools from sliding



WARNING



• Do not open multiple drawers  
• Read safety precautions on page 162



# Tool Storage Roll Carts / Tool Boxes

## 4 Drawers Sliding Top Roll-Cart

KRBCSSTPCM  
Order NO.: 102009



	Cubic (cm <sup>3</sup> )	Net Weight (kg)	Load Capacity (kg)	
	261,062	56	136	
	Drawers	Width (mm)	Depth (mm)	Height (mm)
Specifications	2	747	524	982
Top Compartment	—	747	524	172
Drawers	2	745	445	69
Bottom Shelf	—	745	445	76

Colors Available

KRBCSST

Order NO.: 102010

- Padded lid protects finish and provides additional work surface
- Roller bearing slide drawers, locking slide top, internal prybar holder
- Dual locking casters keep cart in place during use

## 2 Drawers Flip-Top Roll-Cart

KRBC15TPCM  
Order NO.: 102013



	Net Weight (kg)	Load Capacity (kg)		
	40	136		
	Drawers	Width (mm)	Depth (mm)	Height (mm)
Specifications	4	671	465	1,077
Trays	—	660	300	112
Drawer	2	572	386	97
Bottom Shelf	1	667	456	331

\*Shown here with optional top chest  
KRBC15TPCMTC not included

Colors Available

KRBC15T

Order NO.: 102014

- Padded lid protects finish and provides additional work surface
- Removable top chest locks to cart
- Two roller bearing slide drawers on both the top chest and cart
- EVA liners in all drawers and bottom compartment

## Metal Tool Box

KRBK17  
Order NO.: 103016



Length (mm)	Width (mm)	Height (mm)
425	153	114

- Portable steel tool box for users who prefer metal material over plastic
- High grade steel for greater strength & toughness
- DuPont PE powder painting for better protection against peel

## Metal Tool Box

KRBK24  
Order NO.: 103017



Length (mm)	Width (mm)	Height (mm)
511	199	195

- Portable steel tool box for users who prefer metal material over plastic
- High grade steel for greater strength & toughness
- PE powder painting for better protection against peel
- Triple latched to prevent box from opening when dropped
- Additional internal metal tray for separating small tools

## Tool Box 18"

KRW48C  
Order NO.: 103002



Cubic (cm <sup>3</sup> )	Dimensions (mm)
25,070	457 x 254 x 337

- Split top opening for tool access
- Cantilever trays on either side of cover, carrying handle



# Tool Storage Tool Boxes



## Tool Box 24"

**KRU24B**  
Order NO.: 103003



Cubic (cm <sup>3</sup> )	Dimensions (mm)
41,623	Trays: 546 x 117 x 36 Bottom Section: 599 x 295 x 184 Overall: 610 x 305 x 305

- Rugged construction featuring reinforced feet formed cantilever bars and larger hasps for strength in use
- Comfortable, recessed soft grip handle permits stacking of kits or other items in transit
- Cantilever design allows immediate visibility and access to all your tools
- Huge bottom section holds large items, such as power tools and larger hand tools
- Lightweight: 12.3 kg

## Tool Box 18", 2 Drawers

**KRW182B**  
Order NO.: 103004



Cubic (cm <sup>3</sup> )	Dimensions (mm)
18,630	470 x 216x 241

- Net weight: 5.67 kg
- Shipping weight: 6.58 kg

## Tool Box 20", 3 Drawers

**KRW183C**  
Order NO.: 103005



Cubic (cm <sup>3</sup> )	Dimensions (mm)
26,830	Overall: 523 x 216 x 305 Each Drawer: 452 x 186 x 64

- Drawers lock when lid is closed
- Net weight: 9.07 kg

## Tool Box 20", 4 Drawers

**KRW184B**  
Order NO.: 103006



Cubic (cm <sup>3</sup> )	Dimensions (mm)
30,330	Overall: 523 x 216 x 362 Each Drawer: 452 x 186 x 64

- Four drawers lock when lid is closed
- Tote tray not included
- Net weight: 11.07 kg

## Plastic Tool Box 20"

**BPBOX20**  
Order NO.: 103018



Top lid can be opened to store small items



Inner tray provided for neater storage of items



WARNING



• Do not open multiple drawers  
• Read safety precautions on page 162



# Tool Storage Tool Boxes

## Tool Bag 17"



**BPTOTE**  
Order NO.: 103001

Length (mm)	Width (mm)	Height (mm)
419	267	311

- Rugged and versatile
- Constructed from heavy duty 600 x 300D polyester
- Water resistant
- Embroidered Blue-Point® logo
- Wide top opening for easy access
- Multiple interior and external pockets for tool organization

## Plastic Tool Box 18"



**BPBOX18**  
Order NO.: 103014

Length (mm)	Width (mm)	Height (mm)
445	240	206

- Steel pins for extra durable usage, connecting the lid and the box
- Strong handle and lock material
- Separate top tray to hold small tools

## Plastic Tool Box 20"



**BPBOX20**  
Order NO.: 103018

Length (mm)	Width (mm)	Height (mm)
558	277	270

- Larger capacity 20" box
- Made from shock-resistant ABS and PP for durability and toughness
- Light weight and portable
- Removable dividers
- Steel pins connecting the lid and box for strength
- Strong handle and lock material

## Plastic Tool Box 15"



**YA481**  
Order NO.: 103009

Length (mm)	Width (mm)	Height (mm)
368	184	114

- Ideal for a wide range of storage needs
- YA481 through YA486 are made of tough, injection molded plastic to ensure a precise fitting lid and durability
- Top carrying handle, tension latches, tote tray, and padlock provision are also featured

## Plastic Tool Box 16"



**YA482**  
Order NO.: 103010

Length (mm)	Width (mm)	Height (mm)
419	210	165

- Ideal for a wide range of storage needs
- YA481 through YA486 are made of tough, injection molded plastic to ensure a precise fitting lid and durability
- Top carrying handle, tension latches, tote tray, and padlock provision are also featured

## Plastic Tool Box 20"



**YA483**  
Order NO.: 103011

Length (mm)	Width (mm)	Height (mm)
514	229	197

- Ideal for a wide range of storage needs
- YA481 through YA486 are made of tough, injection molded plastic to ensure a precise fitting lid and durability
- Top carrying handle, tension latches, tote tray, and padlock provision are also featured

## Plastic Tool Box 23"



**YA484**  
Order NO.: 103012

Length (mm)	Width (mm)	Height (mm)
587	260	267

- Ideal for a wide range of storage needs
- YA481 through YA486 are made of tough, injection molded plastic to ensure a precise fitting lid and durability
- Top carrying handle, tension latches, tote tray, and padlock provision are also featured

## Plastic Tool Box 27"



**YA486**  
Order NO.: 103013

Length (mm)	Width (mm)	Height (mm)
699	340	356

- Ideal for a wide range of storage needs
- YA481 through YA486 are made of tough, injection molded plastic to ensure a precise fitting lid and durability
- Top carrying handle, tension latches, tote tray, and padlock provision are also featured

# Tool Storage Roll Cab Accessories



## Roll Cab Tops



Stock No.	Size (mm)	Description	Packing	Order No.
SKRWT4008	660	wooden top	1	101013
SKRWT4800B	1016	wooden top	1	101014
SKRSST4107	1016	stainless steel top	1	101015

- For use with all Blue-Point roll-cabs of respective sizes (KRB13008KPRB/R uses 1016mm, other models use 660mm)

## Pry Bar Box



1470K-AC2  
Order NO.: 103021

- 1470K-AC2 Lockable holder for up to 23 pry bars or screwdrivers
- 18 Steel Gauge thickness
- PE paint, PE texture
- Applicable for Asia Market Only

## Roll Cab Slots & Dots Side Panel



1470K-ACSIDE  
Order NO.: 103019

- Slots-N-Dots™ side panel 822 x 419 x 20mm
- Can be hung or screwed on the roll cab side wall
- Mix and match storage accessories
- 18 Steel Gauge thickness
- PE paint, PE texture

## Can Holder



1470K-AC3  
Order NO.: 103022

- 1470K-AC3 18" storage tray; holds up to 6 cans
- 18 Steel Gauge thickness
- PE paint, PE texture
- Applicable for Asia Market Only

## Foldable Tray



1470K-AC1  
Order NO.: 103020

- 1470K-AC1 Folding shelf; 35kg loading capacity
- 18 Steel Gauge thickness
- PE paint, PE texture
- Applicable for Asia Market Only

## Document Holder



1470K-AC4  
Order NO.: 103023

- 1470K-AC4 14" Document holder
- 18 Steel Gauge thickness
- PE paint, PE texture
- Applicable for Asia Market Only



WARNING



• Do not open multiple drawers  
• Read safety precautions on page 162



Our tool sets comprise of quality tools each carefully selected to suit applications that the set is created for.

Every set is designed to avoid duplication of tools so that you can get a series of tool sets that are complimentary without having too many of the same tools.

Likewise, the tools in each set have been streamlined to cater more accurately to the task and environment it has been created for so you do not pay for tools you will not need.

You will likely find a set that fits your needs in our growing range of tool sets catered to meet today's most commonly faced applications.



## Master Tool Sets





General  
Service  
Sets

10

Automotive  
Tool Sets

14

Modular  
Tool Sets

17

# Master Tool Sets General Service Sets

## 1/4" & 3/8" Drive Socket Set, 155pcs

BLPGSSC155  
Order NO.: 201001



### Set Components (1/4" Drive):

- 10 fractional (3/16" to 9/16") and 13 metric (4 to 14mm) standard sockets
- 10 fractional (3/16" to 9/16") and 11 metric (4 to 14mm) deep sockets
- 20 assorted 1/4" hex bits with bit holder
- 5 ratchet/socket accessories
- 1 quick release ratchet

### Set Components (3/8" Drive):

- 13 fractional (1/4" to 1") and 19 metric (6 to 24mm) standard sockets
- 11 fractional (3/8" to 1") and 15 metric (10 to 24mm) deep sockets
- 11 external Torx® sockets (E4 to E20)
- 2 spark plug sockets (5/8", 13/16")
- 3 metric hex socket drivers (7, 8, 10mm)
- 4 tamper resistant Torx® socket drivers (T40, T45, T50, T55)
- 6 ratchet/socket accessories
- 1 quick release ratchet
- 1 spinner handle
- Storage case included

## 1/4" & 1/2" Drive Socket & Tool Set, 78pcs

BLPGSSCM78  
Order NO.: 201003



### Set Components (1/4" Drive):

- 12 sockets (4, 4.5, 5, 5.5, 6, 7, 8, 9, 10, 11, 12, 13mm)
- 4 accessories (quick release ratchet, spinner handle, 4" extension bar and 1/4" F \* 1/4" H coupler)

### Set Components (1/2" Drive):

- 21 sockets (8, 9, 10, 11, 12, 13, 14, 15, 16, 17, 18, 19, 20, 21, 22, 23, 24, 27, 30, 32, 34mm)
- 7 accessories (quick release ratchet, 16mm & 21mm spark plug socket, 3", 6" & 10" extension bar, 3/8" F \* 1/2" M 3 way adapter)

### Set Components:

- 20 bits: hex bit (3, 4, 5, 6mm), Phillips® bits (#0, #1, #2, #3), square bit (S1 & S2), flat bit (4, 5, 5.5mm), Torx® bits (T8, T10, T15, T20, T25, T27, T30)
- 10 combination wrenches (10, 11, 12, 13, 14, 15, 16, 17, 18, 19mm)
- 3 pliers (side cutter (7"), long nose pliers (6"), slip joint pliers (10"))
- 1 adjustable wrench (8")
- Storage case included

## 1/4" & 1/2" Drive Socket & Tool Set



Tough molded case



Specific size indicated on tool case for each tool



Divider with individual tool illustrations



Secure lock prevents opening when dropped

Rubberized handle with no gaps for comfort

# Master Tool Sets General Service Sets

## 1/4" & 3/8" Drive Socket & Wrench Set, 100pcs

BLPGSSC100  
Order NO.: 201002



- Set Components (1/4" Drive):**
- 10 fractional (3/16" to 9/16") and 13 metric (4 to 14mm) standard sockets
  - 5 ratchet/socket accessories
  - 1 ratchet
- Set Components (3/8" Drive):**
- 13 fractional (1/4" to 1") and 19 metric (6 to 24mm) standard sockets
  - 11 external Torx® sockets (E4 to E20)
  - 2 spark plug sockets (5/8", 13/16")
  - 5 ratchet/socket accessories
  - 1 ratchet
  - 1 spinner handle
- Set Components (Combination Wrenches):**
- 9 fractional combination wrenches (1/4" to 3/4")
  - 10 metric combination wrenches (10 to 19mm)
  - Storage case included

## 1/4", 3/8" & 1/2" Drive Torx® Bit Socket Set, 43pcs

BLPTSSC43  
Order NO.: 201004



- Set Components (1/4" drive):**
- 5 external Torx® sockets (E4 to E8)
  - 10 tamper resistant Torx® socket drivers (T6 to T10, T15, T20, T25, T27, T30)
  - 10 tamper resistant long Torx® socket drivers (T6 to T10, T15, T20, T25, T27, T30)
- Set Components (3/8" drive):**
- 4 external Torx® sockets (E10, E12, E14, E16)
  - 3 tamper resistant Torx® socket drivers (T40, T45, T50)
  - 3 tamper resistant long Torx® socket drivers (T40, T45, T50)
- Set Components (1/2" drive):**
- 4 external Torx® sockets (E18, E20, E22, E34)
  - 2 tamper resistant Torx® socket drivers (T55, T60)
  - 2 tamper resistant long Torx® socket drivers (T55, T60)
  - Storage case included



## 1/4" Drive Stubby Bit Socket Set, 40pcs

BLPBSS40  
Order NO.: 201005



- Set Components:**
- 10 metric hex drivers (2, 2.5, 3, 4, 5, 6, 7, 8, 9, 10mm)
  - 10 fractional hex drivers (5/64", 3/32", 7/64", 1/8", 5/32", 3/16", 7/32", 1/4", 5/16", 3/8")
  - 10 Torx® tamper proof drivers (TP8, TP10, TP15, TP20, TP25, TP27, TP30, TP40, TP45, TP50)
  - 6 XZN triple square drivers (XZN4, XZN5, XZN6, XZN8, XZN10, XZN12)
  - 2 Phillips® drivers (#1, #2)
  - 2 flat tip drivers (1/4", 3/8")
  - Storage case included

## 1/4" Drive Socket Set, 62pcs

BLPGSS1462  
Order NO.: 201006



- Set Components:**
- 11 fractional (3/16" to 5/8") and 11 metric (4mm to 14mm) standard sockets
  - 11 fractional (3/16" to 5/8") and 11 metric (4mm to 14mm) deep sockets
  - 1 bit holder
  - 4 hex bits (9/64", 3/16", 7/32", 1/4")
  - 3 flat tip bits (5/32", 3/16", 1/4")
  - 2 Phillips® bits (#1, #2)
  - 7 ratchet/socket accessories
  - 1 ratchet
  - Storage case included

# Master Tool Sets General Service Sets

## 1/4" Drive Socket Set, 51pcs

BLPGSS1451A  
Order NO.: 201007



### Set Components:

- 10 fractional (3/16" to 9/16") and 13 metric (4 to 14mm) standard sockets
- 3 fractional (1/4", 5/16", 3/8") 8 pt. sockets
- 6 Torx® socket drivers (T8 to T27)
- 6 fractional hex socket drivers (1/8" to 5/16")
- 3 flat tip socket drivers (5/32", 7/32", 9/32")
- 3 Phillips® socket drivers (#0, #1, #2)
- 6 ratchet/socket accessories
- 1 ratchet
- Storage case included

## 1/4" Drive SAE Socket Set, 22pcs

BLPGSS1422  
Order NO.: 201008



### Set Components:

- 11 6 pt. sockets (3/16", 7/32", 1/4", 9/32", 5/16", 11/32", 3/8", 7/16", 1/2", 9/16", 5/8")
- 11 6 pt. deep sockets (3/16", 7/32", 1/4", 9/32", 5/16", 11/32", 3/8", 7/16", 1/2", 9/16", 5/8")
- Storage case included

## 3/8" Drive Socket Set, 85pcs

BLPGSS3885  
Order NO.: 201009



### Set Components:

- 13 fractional (1/4" to 1") and 14 metric (6 to 19mm) standard sockets
- 13 fractional (1/4" to 1") and 14 metric (6 to 19mm) deep sockets
- 11 external Torx® sockets (E4 to E20)
- 1 Phillips® socket driver (#3)
- 2 Pozidriv® socket drivers (#3 and #4)
- 8 tamper resistant Torx® socket drivers (T10 to T45)
- 2 spark plug sockets (5/8", 13/16")
- 4 ratchet/socket accessories
- 1 ratchet
- 1 breaker bar
- 1 spinner handle
- Storage case included

## 3/8" Drive SAE Socket Set, 71pcs

BLPGSSCT71  
Order NO.: 201010



### Set Components:

- 9 fractional combination wrenches (1/4" to 3/4")
- 10 metric combination wrenches (10 to 19mm)
- 12 fractional (5/16" to 1") and 15 metric (10 to 24mm) 6 pt. standard sockets
- 2 spark plug sockets (5/8", 13/16")
- 1 quick release ratchet
- 1 spinner handle
- 3 extensions (3", 6", 10")
- 1 bit holder (3/8" drive)
- 4 hex bits (1/8", 5/32", 7/32", 1/4")
- 3 flat tip bits (5/32", 3/16", 1/4")
- 4 Phillips® tip bits (#0, #1, #2, #3)
- 2 square tip bits (#1, #2)
- 1 diagonal cutting pliers (7")
- 1 long nose pliers (6")
- 1 groove joint pliers (10")
- 1 adjustable wrench (8")
- Storage case included



# Master Tool Sets General Service Sets

## 3/8" Drive Socket Set, 49pcs

BLPGSS3849  
Order NO.: 201011



**Set Components:**

- 8 fractional (5/16" to 3/4") and 14 metric (6 to 19mm) standard 6 pt. sockets
- 8 fractional (5/16" to 3/4") and 13 metric (7 to 19mm) deep 12 pt. sockets
- 2 extensions (3", 6")
- 1 universal joint
- 1 3/8" female to 1/4" male Adaptor
- 1 ratchet
- Storage case included

## 3/8" Drive Socket & Wrench Set, 37pcs

BLPGSS3837  
Order NO.: 201012



**Set Components:**

- 8 fractional (5/16" to 3/4") and 14 metric (6 to 19mm) standard 6 pt. sockets
- 4 fractional (5/16"-3/8", 7/16"-1/2", 9/16"-5/8", 11/16"-3/4") and 5 metric (10-11mm, 12-13mm, 14-15mm, 16-17mm, 18-19mm) double open end wrenches
- 2 extensions (3", 6")
- 1 ratchet
- 1 universal joint
- 2 adaptors: 1/4" female x 3/8" male, 3/8" female x 1/4" male
- Storage case included



## Pass Thru Socket Set, 22pcs

BLPPTSS3822  
Order NO.: 201013



**Set Components:**

- BLPPTS38 thru BLPPTS34 (3/8" to 3/4") sockets
- BLPPTSM8 thru BLPPTSM19 (8 to 19mm) metric sockets
- BLPPTA3438 pass thru adaptor
- BLPPTXT3 extension and BPRFPT10 ratchet
- Storage case included

## 1/2" Drive Socket Set, 33pcs

BLPGSS1233  
Order NO.: 201014



**Set Components:**

- 15 fractional (3/8" to 1 1/4") and 12 metric (12 to 24mm) standard sockets
- 1 breaker bar
- 1 universal joint
- 1 quick release ratchet
- 3 extensions (3", 6", 10")
- Storage case included



WARNING



• Do not use chrome or industrial finish hand tools with impact drivers  
• Read safety precautions on page 162

# Master Tool Sets General Service Sets / Automotive Tool Sets

## General Service Set, 27pcs

BLPGSS1427  
Order NO.: 202010



### Imperial Set:

- 11 Fractional (3/16" to 5/8") 6 pt. Shallow Sockets
- 11 Fractional (3/16" to 9/16") 6 pt. Deep Sockets
- 3 Socket Adaptors/Extensions
- 1 Quick Release Ratchet & 1 Spinner Handle

### FEATURES:

- Square Drive: 1/4"
- Good for automotive and home use
- Range of deep and shallow sockets for common fastener applications
- Ratchet and Handle Driver both available for a variety of jobs

## 3/8" Drive Socket Set, 77pcs

BLPATSM3877  
Order NO.: 202005



### Set Components:

- 19 6 pt. sockets (6, 7, 8, 9, 10, 11, 12, 13, 14, 15, 16, 17, 18, 19, 20, 21, 22, 23, 24mm)
- 19 12 pt. deep sockets (6, 7, 8, 9, 10, 11, 12, 13, 14, 15, 16, 17, 18, 19, 20, 21, 22, 23, 24mm)
- 11 external Torx® sockets (E4, E5, E6, E7, E8, E10, E12, E14, E16, E18, E20)
- 4 hex bit sockets (6, 7, 8, 10mm)
- 2 Phillips® bit sockets (#3, #4)
- 2 PZ bit sockets (#3, #4)
- 8 tamper Torx® bit sockets (TT10, TT15, TT20, TT25, TT27, TT30, TT40, TT45)
- 12 accessories (quick release ratchet, 3", 6" & 10" extension bar, 16 & 21mm spark plug sockets, universal joint, 10" flexible handle, 3/8" female x 1/2" male adapter, 3/8" female x 1/4" male adapter, spinner handle, 8" sliding T-handle)
- Storage case included

## 1/4", 3/8" & 1/2" Drive Socket & Wrench Set, 100 pcs

BLPATSCM100  
Order NO.: 202001



### Set Components (1/4" drive):

- 10 sockets (4, 5, 6, 7, 8, 9, 10, 11, 12, 13mm)
- 10 deep sockets (4, 5, 6, 7, 8, 9, 10, 11, 12, 13mm)
- 6 accessories (quick release ratchet handle, spinner handle, 1 1/2" & 3" extension bar, universal joint, 6" flexible handle)
- 6 hex bit sockets (3, 4, 5, 6, 7, 8mm)
- 7 flat & Phillips® bit sockets (4, 5.5, 6.5mm, #0, #1, #2, #3)
- 4 PZ bit sockets (#0, #1, #2, #3)
- 7 tamper Torx® bit sockets (TT10, TT15, TT20, TT25, TT27, TT30, TT40)

### Set Components (3/8" drive):

- 10 6 pt. sockets (10, 11, 12, 13, 14, 15, 16, 17, 18, 19mm)
- 10 deep 12 pt. sockets (10, 11, 12, 13, 14, 15, 16, 17, 18, 19mm)
- 10 accessories (quick release ratchet, 3", 6" & 10" extension bar, 16mm & 21mm spark plug socket, universal joint, 10" flexible handle, 3/8" female x 1/4" male adapter, 8" sliding T-handle)

### Set Components (1/2" drive):

- 6 12 pt. sockets (20, 21, 22, 24, 27, 32mm)
- 8 6 pt. impact sockets (14, 15, 16, 17, 18, 19, 21, 22mm)
- 2 accessories (ratchet handle, 5" extension bar)

### Set Components:

- 4 ratcheting wrenches (13, 14, 15, 17mm)
- Storage case included

## 1/4" Dr. Socket Set, 29pcs

BLPATSM1429  
Order NO.: 202002



### Set Components:

- 13 6 pt. sockets (4, 4.5, 5, 5.5, 6, 7, 8, 9, 10, 11, 12, 13, 14mm)
- 11 6 pt. deep sockets (4, 5, 6, 7, 8, 9, 10, 11, 12, 13, 14mm)
- 5 accessories (quick release ratchet, spinner handle, 3" & 6" extension bar, universal joint)
- Storage case included

# Master Tool Sets Automotive Tool Sets

## Automotive Tool Set, 120pcs

BLPATSCM120  
Order NO.: 202008



### FEATURES:

- Specially Catered to Automotive Workshop
- Complete Set of Common Tools Needed for Regular Passenger Vehicle Servicing
- Three Square Drive Sizes range of Sockets
- Oil-Filter Wrench
- Spark Plug Sockets
- Set of L-Shaped Wrenches
- Test Pen

### Set Components:

- 1/4" Socket 4, 5, 6, 7, 8, 9, 10, 11, 12, 13mm
- 1/4" Deep Socket 8, 9, 10, 12mm
- 1/4" Ratchet
- 1/4" Spinner Handle
- 1/4" Extension Bar 3"
- 1/4"F\*1/4"H Coupler
- 1/4" Universal Joint
- 1/4" Hex Bit Socket 3, 4, 5, 6, 7, 8mm
- 1/4" Flat Bit Socket 4, 5.5, 6.5mm
- 1/4" Phillips Bit Socket #1, #2, #3
- 1/4" Pozidriv Bit Socket #1, #2
- 1/4" Torx Bit Socket TT10, TT15, TT20, TT25, TT30, TT40
- 3/8" Socket 10, 11, 12, 13, 14, 15, 16, 17, 18, 19mm
- 3/8" 12pt Deep Socket 13, 14, 15, 17mm
- 3/8" E8, E10, E11, E12, E14, E16, E18, E20
- 3/8" Ratchet
- 3/8" 3" Extension Bar, 6" Extension Bar
- 3/8" Spark Plug Socket 16, 21mm
- 3/8" Universal Joint
- 3/8" Female to 1/4" Male Adaptor
- 3/8" 8" Sliding Handle
- 1/2" 6pt. Socket 20, 21, 22, 24, 27, 32mm
- 1/2" Impact Socket 17, 19, 21, 23mm
- 1/2" Ratchet
- 1/2" 5" Extension Bar
- 1/2" 10" Extension Bar
- 1/2" Universal Joint
- 1/2" Female to 3/8" Male Adaptor
- Adjustable 3-Claw Oil Wrench
- Test Pen
- Hex Key Set (9pcs)
- Bit Set (20pc)
- Combi Wrench 8, 9, 10, 11, 12, 13, 14, 16, 17, 18, 19mm
- Socket for air cylinder T52

## 3/8" Drive Socket Set, 24pcs

BLPATSM3824  
Order NO.: 202004



### Set Components:

- 10 12 pt. sockets (10, 11, 12, 13, 14, 15, 16, 17, 18, 19mm)
- 10 12 pt. deep sockets (10, 11, 12, 13, 14, 15, 16, 17, 18, 19mm)
- 4 accessories (quick release ratchet, 3" extension bar, 16 & 21mm spark plug sockets)
- Storage case included

## 1/4", 3/8" & 1/2" Socket Set, 128pcs

BLPATSCM128  
Order NO.: 202007



### Set Components (1/4" Drive):

- 10 6pt. metric (4 to 13mm) deep sockets
- 10 6pt. metric (4 to 13mm) standard sockets
- 24 socket driver: Flat (4, 5.5, 6.5mm), Hex (3, 4, 5, 6, 7, 8mm), Phillips® (#0, 1, 2, 3), Tamper Resistant Torx® (T10, 15, 20, 25, 27, 30, 40), Pozidriv® (#0, 1, 2, 3)
- 7 accessories (38mm & 75mm extension bar, universal joint, 6" flexible handle, 6" spinner handle, quick release ratchet handle, 1/4"F\*1/4"H bit adaptor)
- 17 bits: Hex (1/8, 5/32, 3/16, 7/32, 1/4"), Flat (7/32, 3/16, 1/4, 9/32"), bit adaptor, Torx® (T8, T10, T15, T20, T25, T27, T30, T40)

### Set Components (3/8" Drive):

- 10 12pt. metric (10 to 19mm) deep sockets
- 10 6pt. metric (10 to 19mm) standard sockets
- 10 accessories (3/8" female x 1/4" male adaptor, 75mm, 150mm & 250mm extension bar, 10" flexible handle, quick release ratchet handle, universal joint, 8" sliding bar, 6pt. 16mm & 21mm spark plug socket)

### Set Components (1/2" Drive):

- 6 6pt. metric (20, 21, 22, 24, 27, 32mm) standard sockets
- 8 6pt. metric (14, 15, 16, 17, 18, 19, 21, 22mm) impact sockets
- 3 accessories (125mm extension bar, quick release ratchet handle, 1/2" female x 1/4" hex coupler)

### Set Components:

- 4 ratcheting wrenches (13, 14, 15, 17mm)
- 9pcs hex key set (1.5, 2, 2.5, 3, 4, 5, 6, 8, 10mm)
- Storage case included

# Master Tool Sets Automotive Tool Sets

## Socket Set, 32pcs

BLPATSM1232  
Order NO.: 202009



**Set Components:**

- 1/2" 6pt Socket 8, 9, 10, 11, 12, 13, 14, 15, 16, 17, 18, 19, 20, 21, 22, 23, 24, 27, 30, 32mm
- 1/2" 12pt Socket 8, 10, 12, 13, 14, 17, 19mm
- 1/2" Ratchet
- 1/2" Extension Bar 5", 10"
- 1/2" Universal Joint
- 1/2" Sliding Adapter 1/2" F – 3/8" M

**FEATURES:**

- For Automotive and General Fastener Tightening Jobs
- Square Drive: 1/2"
- Improves on existing BLPATSM1225
- Includes smaller sizes 8, 9 & 23 mm sockets
- Additional range of 12 points sockets
- Universal Joint Added for more Applications

## 1/2" Drive Socket Set, 25pcs

BLPATSM1225  
Order NO.: 202003



**Set Components:**

- 19 6 pt. sockets (10, 11, 12, 13, 14, 15, 16, 17, 18, 19, 20, 21, 22, 24, 27, 30, 32, 34, 36mm)
- 6 accessories (quick release ratchet, 5" & 10" extension bar, 3/8" female x 1/2" male 3 way adapter, 16 & 21mm spark plug socket)
- Storage case included

## Impact Socket Set, 13pcs

BLPATSIMM3813  
Order NO.: 202011



**Set Components:**

- 3/8" Dr. Shallow Impact Socket 7, 8, 9, 10, 11, 12, 13, 14, 15, 16, 17, 18, 19mm

**FEATURES:**

- Square Drive: 3/8"
- Catered to Complement 3/8" Impact Wrenches
- Automotive and Two-Wheelers Workshops
- Compact Set with Only Commonly Used Sizes
- Complements existing BLPATSIMM1215 (1/2")

## 1/2" Drive Impact Socket Set, 15pcs

BLPATSIMM1215  
Order NO.: 202006



**Set Components:**

- 14 6 pt. impact sockets (10, 11, 12, 13, 14, 15, 16, 17, 18, 19, 21, 22, 23, 24mm)
- 1 impact extension bar (5")
- Storage case included

# Master Tool Sets Modular Tool Sets

## Double Open End Wrench Set

BPS1  
Order NO.: 202012



- Set Components:**
- Double Open End Wrench  
6x7, 8x9, 10x11, 12x13, 14x15, 16x17, 18x19, 20x22, 21x23, 24x27, 30x32mm

## Combination Wrench Set

BPS4P  
Order NO.: 202015



- Set Components:**
- Combination Wrench  
6, 7, 8, 9, 10, 11, 12, 13, 14, 15, 16, 17, 18, 19mm



## 45° Double Ring Wrench Set

BPS2  
Order NO.: 202013



- Set Components:**
- 45° Double Ring Wrench  
6x7, 8x9, 10x11, 12x13, 14x15, 16x17, 18x19, 20x22, 21x23, 24x27mm

## Ratcheting Combination Wrench Set

BPS5  
Order NO.: 202016



- Set Components:**
- Ratcheting Combination Wrench  
6, 7, 8, 9, 10, 11, 12, 13, 14, 15, 16, 17, 18, 19mm

## 75° Double Ring Wrench Set

BPS3  
Order NO.: 202014



- Set Components:**
- 75° Double Ring Wrench  
6x7, 8x9, 10x11, 12x13, 14x15, 16x17, 18x19, 20x22, 21x23, 24x27mm

## Adjustable Wrench Set

BPS6 / BPS6A\*\*  
Order NO.: 202017 / 202027



- Set Components:**
- Adjustable Wrench, 8, 10"
  - Curved Jaw Locking Pliers, 7"
  - Straight Jaw Locking Pliers, 7"
- \*\*BPS6A - for China & India only

# Master Tool Sets Modular Tool Sets

## 1/4" Square Drive Socket Set

BPS10  
Order NO.: 202021



### Set Components:

- 1/4" Long Sockets 4, 5, 6, 7, 8, 9, 10, 11, 12, 13, 14mm
- 1/4" Hex Socket Driver 3, 4, 5, 6, 7, 8mm
- 1/4" Flat Socket Driver 4, 5.5, 6.5mm
- 1/4" Phillips Socket Driver #1, 2, 3
- 1/4" Pozidriv Socket Driver #1, 2, 3
- 1/4" Torx Socket Driver T8, 10, 15, 20, 25, 27, 30, 40
- 1/4" Sockets 3.5, 4, 4.5, 5, 5.5, 6, 7, 8, 9, 10, 11, 12, 13mm
- 1/4" Quick Release Ratchets Soft Handle
- 1/4" Spinner Handle
- 1/4" Extension Knurled 2.3/3.2"
- 1/4" Extension Knurled 4"
- 1/4" Sliding T-handle 4"
- 1/4" Universal Joint
- 1/4" Flexible Extension 6"
- 1/4" Bit Holder for 1/4" Hex
- 1/4" Adaptor 1/4"-3/8"

## Standard Pliers Set

BPS7  
Order NO.: 202018



### Set Components:

- 6" Needle Nose Pliers
- 6" Diagonal Cutting Pliers
- 8" Combination Pliers
- 8" Slip Joint Pliers

## Circlip Pliers Set

BPS8  
Order NO.: 202019



### Set Components:

- External Circlip Pliers, Straight, 7"
- External Circlip Pliers, 90 degrees, 7"
- Internal Circlip Pliers, Straight, 7"
- Internal Circlip Pliers, 90 degrees, 7"

## Screwdrivers Set

BPS9  
Order NO.: 202020



### Set Components:

- M Series Flat Tip 3.2x75, 5x100, 6x38, 6x150mm
- M Series Phillips Tip 0x75, 1x75, 2x38, 2x100, 3x150mm

# Master Tool Sets Modular Tool Sets

## 3/8" Square Drive Socket Set

BPS11  
Order NO.: 202022



**Set Components:**

- 3/8" Sockets 6, 7, 8, 9, 10, 11, 12, 13, 14, 15, 16, 17, 18, 19, 20, 21, 22, 23, 24mm
- 3/8" Long Sockets 10, 11, 12, 13, 14, 15, 16, 17, 18, 19mm
- 3/8" Quick Release Ratchets Soft Handle
- 3/8" Spark Plug Sockets 16mm
- 3/8" Spark Plug Sockets 21mm
- 3/8" Sliding T-handle 8"
- 3/8" Adaptor 3/8"-1/4"
- 3/8" Universal Joint
- 3/8" Locking Extension 3"

## Impact Socket Set

BPS13  
Order NO.: 202024



**Set Components:**

- 1/2" Impact Sockets 10, 11, 12, 13, 14, 15, 16, 17, 18, 19, 21, 22, 24, 27, 30, 32mm
- 3/8" Impact Sockets 7, 8, 9, 10, 11, 12, 13, 14, 15, 16, 17, 18, 19mm
- Impact Extensions 3/8" dr. x 3"
- 3/8" Dr. Adaptors 3/8"M x 1/4"F
- Impact Adaptors (M X F) 3/8" x 1/2"
- Impact Extensions 1/2" dr. x 6"
- Impact Adaptors (M X F) 1/2" x 3/8"
- Impact Adaptors (M X F) 1/2" x 3/4"
- Universal Joints 1/2" dr.

## 1/2" Square Drive Socket Set

BPS12  
Order NO.: 202023



**Set Components:**

- 1/2" Sockets 10, 11, 12, 13, 14, 15, 16, 17, 18, 19, 21, 22, 24, 27, 30, 32, 34mm
- 1/2" Long Sockets 10, 13, 17, 19, 22mm
- 1/2" Quick Release Ratchets Soft Handle
- 1/2" Sliding T-handle 15"
- 1/2" Universal Joint
- 1/2" Locking Extension 6"

## L-Shape Wrench Set

BPS14  
Order NO.: 202025



**Set Components:**

- Ball Hex Keys Set 1.5-10mm
- L-Shape Torx Wrench Set T10-T50
- L-Shape Hex Keys 12, 14, 17, 19mm



WARNING



• Do not use chrome or industrial finish hand tools with impact drivers  
• Read safety precautions on page 162



# SOCKETS, RATCHETS & ACCESSORIES

Blue-Point sockets & ratchets are made combining high grade materials with the best manufacturing process available to ensure good performance and fit.

## High Grade Materials

Sockets are made with high alloy content steel for a stronger, more durable tool.

## Best Industrial Manufacturing Process

In making each socket, we employ the best manufacturing process available, adhering to exact treatment conditions and parameters to give it a good mixture of strength and durability.

## Better Socket Design

Our sockets are thin-walled with appropriate broach depth to provide greater access into tight spots and fit better for more applications.

## Patented Wrenching System

Flank Drive<sup>®</sup> is also incorporated into our socket design to achieve a higher torque while preventing rounding of fasteners.





### High Efficiency

The ratcheting gear in Blue-Point ratchets feature high teeth count for working with a shorter swing arc. This allows jobs to be done in tight spots as well as enhancing work output with lesser swings needed.

We incorporate better design and concept wherever applicable to make a better performing tool. Blue-point sockets & ratchets are tools manufactured to the highest quality.



1/4"

22

3/8"

27

1/2"

33

3/4"

37

# Sockets, Ratchets & Accessories 1/4"

## 1/4" Socket, mm

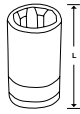

Stock No.	Size (mm)	Length (mm)		Order No.
BLPSM143.5	3.5	25	6	301001
BLPSM144	4	25	6	301002
BLPSM144.5	4.5	25	6	301003
BLPSM145	5	25	6	301004
BLPSM145.5	5.5	25	6	301005
BLPSM146	6	25	6	301006
BLPSM147	7	25	6	301007
BLPSM148	8	25	6	301008
BLPSM149	9	25	6	301009
BLPSM1410	10	25	6	301010
BLPSM1411	11	25	6	301011
BLPSM1412	12	25	6	301012
BLPSM1413	13	25	6	301013
BLPSM1414	14	25	6	301014

- Manufactured from high grade steel alloy
- Features a Lifetime Warranty and exceeds ANSI Standards

## 1/4" Long Socket, mm

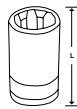

Stock No.	Size (mm)	Length (mm)		Order No.
BLPLSM144	4	50	6	301015
BLPLSM145	5	50	6	301016
BLPLSM146	6	50	6	301017
BLPLSM147	7	50	6	301018
BLPLSM148	8	50	6	301019
BLPLSM149	9	50	6	301020
BLPLSM1410	10	50	6	301021
BLPLSM1411	11	50	6	301022
BLPLSM1412	12	50	6	301023
BLPLSM1413	13	50	6	301024
BLPLSM1414	14	50	6	301025

- Manufactured from high grade steel alloy
- Features a Lifetime Warranty and exceeds ANSI Standards

## 1/4" Socket, inches

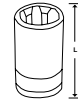

Stock No.	Size (inches)	Length (mm)		Order No.
BLPS14532	5/32	25	6	301026
BLPS14316	3/16	25	6	301027
BLPS14732	7/32	25	6	301028
BLPS1414	1/4	25	6	301029
BLPS14932	9/32	25	6	301030
BLPS14516	5/16	25	6	301031
BLPS141132	11/32	25	6	301032
BLPS1438	3/8	25	6	301033
BLPS14716	7/16	25	6	301034
BLPS1412	1/2	25	6	301035
BLPS14916	9/16	25	6	301036
BLPS1458	5/8	25	6	301037

- Manufactured from high grade steel alloy
- Features a Lifetime Warranty and exceeds ANSI Standards

## 1/4" Long Socket, inches

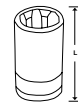

Stock No.	Size (inches)	Length (mm)		Order No.
BLPLS14316	3/16	50	6	301038
BLPLS14732	7/32	50	6	301039
BLPLS1414	1/4	50	6	301040
BLPLS14932	9/32	50	6	301041
BLPLS14516	5/16	50	6	301042
BLPLS141132	11/32	50	6	301043
BLPLS1438	3/8	50	6	301044
BLPLS14716	7/16	50	6	301045
BLPLS1412	1/2	50	6	301046
BLPLS14916	9/16	50	6	301047
BLPLS1458	5/8	50	6	301048

- Manufactured from high grade steel alloy
- Features a Lifetime Warranty and exceeds ANSI Standards

# Sockets, Ratchets & Accessories 1/4"

## 1/4" Double Square Socket



Stock No.	Size (inches)	Length (mm)	Packing	Order No.
BLPS81414	1/4	25	6	301049
BLPS814516	5/16	25	6	301050
BLPS81438	3/8	25	6	301051

- Manufactured from high grade steel alloy
- Features a Lifetime Warranty and exceeds ANSI Standards

## 1/4" External Torx® Socket



Stock No.	Size	Length (mm)	Packing	Order No.
BLPTE144	E4	25	6	301052
BLPTE145	E5	25	6	301053
BLPTE146	E6	25	6	301054
BLPTE147	E7	25	6	301055
BLPTE148	E8	25	6	301056

- Manufactured from high grade steel alloy
- Features a Lifetime Warranty and exceeds ANSI Standards

## Finger Ratchet



Stock No.	Square Drive (inches)	Packing	Order No.
FSD14	3/8 male-1/4 female	1	301059
FSD38	1/4 male-3/8 female	1	301060
FSDR	1/4 male-1/4 female	1	301061

- Reversible, finger ratchet
- Small size works great for extremely tight areas
- Aluminum knurled outer ring for sure grip

## 1/4" Quick Release Ratchet

Packing: 1

BPRT936  
Order NO.: 301057

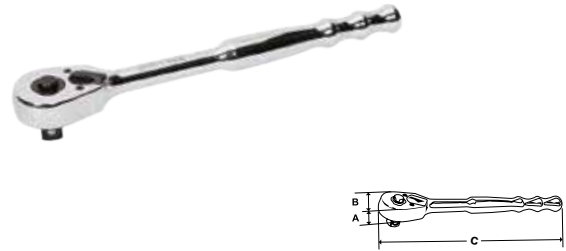

Square Drive (inches)	Description	Gear Teeth
1/4	Standard Handle	36
Swing Arc	A (mm)	B (mm)
10°	12	25
C (mm)	Repair Kit	
143	RKRBPRT936	

- Features quick release button for rapid socket/accessory changes, even with greasy or oily hands
- Contoured handle for comfort and control
- Chrome finish for easy clean-up
- All ratchets in series meet or exceed ANSI B107-10M-1996 specifications
- Uses RKRBPRT936 ratchet service kit

## 1/4" Quick Release Ratchet, Soft Grip

Packing: 1

BPRT936SG  
Order NO.: 301058

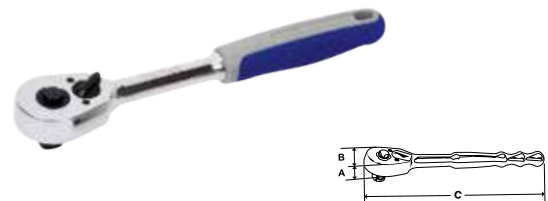

Square Drive (inches)	Description	Gear Teeth
1/4	Soft Grip Handle	36
Swing Arc	A (mm)	B (mm)
10°	12	25
C (mm)	Repair Kit	
143	RKRBPRT936	

- Features quick release button for rapid socket/accessory changes, even with greasy or oily hands
- Corrosive resistant bi-mold cushion grip for improved comfort and performance
- Chrome finish for easy clean-up
- All ratchets in series meet or exceed ANSI B107-10M-1996 specifications
- Uses RKRBPRT936 ratchet service kit



WARNING



• Do not use chrome or industrial finish hand tools with impact drivers  
• Read safety precautions on page 162

# Sockets, Ratchets & Accessories 1/4"

## 1/4" Extension, Knurled



Stock No.	Length (mm)	Packing	Order No.
BLPTXK1.5	40	6	301062
BLPTXK2	51	6	301063
BLPTXK3	76	6	301064
BLPTXK4	102	6	301065
BLPTXK6	152	6	301066

- Manufactured from high grade steel alloy
- Features a Lifetime Warranty and exceeds ANSI Standards

## 1/4" Extension, Extra Long Locking

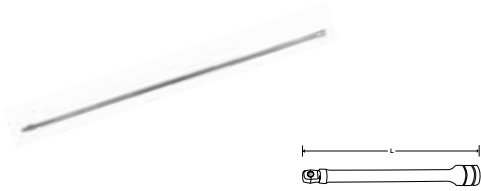

Stock No.	Length (mm)	Packing	Order No.
BLPEXTL1412	305	6	301067
BLPEXTL1418	457	6	301068
BLPEXTL1424	610	6	301069

- Smooth, durable chrome finish
- Made from tough 6130 steel
- Secure socket retention
- Lifetime warranty on individual extensions
- Do not use with power or impact tools

## 1/4" Flexible Extension

Packing: 6

BLPEXTF146  
Order NO.: 301070



Stock No.	Length (mm)
BLPEXTF146	152

- Manufactured from high grade steel alloy
- Features a Lifetime Warranty and exceeds ANSI Standards

## 1/4" Breaker Bar

Packing: 6

BLPBB146  
Order NO.: 301071



Stock No.	Length (mm)
BLPBB146	152

- Manufactured from high grade steel alloy
- Features a Lifetime Warranty and exceeds ANSI Standards

## 1/4" Sliding T-handle, 4"

Packing: 6

BLPSTHD144  
Order NO.: 301072



Stock No.	Length (mm)
BLPSTHD144	114

- Manufactured from high grade steel alloy
- Features a Lifetime Warranty and exceeds ANSI Standards

## 1/4" Spinner Handle

Packing: 6

BLPCGHD146  
Order NO.: 301073



Stock No.	Length (mm)
BLPCGHD146	152

- Manufactured from high grade steel alloy
- Features a Lifetime Warranty and exceeds ANSI Standards

# Sockets, Ratchets & Accessories 1/4"

## 1/4" Universal Joint

Packing: 6



BLPUJ14  
Order NO.: 301074



Stock No.	Length (mm)
BLPUJ14	38

- Manufactured from high grade steel alloy
- Features a Lifetime Warranty and exceeds ANSI Standards

## 1/4" Adaptor

Packing: 6



BLPAFM1438  
Order NO.: 301075

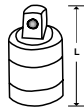

Stock No.	Internal Square Drive (inches)	External Square Drive (inches)
BLPAFM1438	1/4	3/8

- Manufactured from high grade steel alloy
- Features a Lifetime Warranty and exceeds ANSI Standards

## 1/4" Bit Holder

Packing: 6



BLPTMBS1414  
Order NO.: 301076



Stock No.	Length(mm)	Description
BLPTMBS1414	27	for 1/4" Hex Bits

- Manufactured from high grade steel alloy
- Features a Lifetime Warranty and exceeds ANSI Standards

## 1/4" Torx® Socket Driver

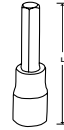

Stock No.	Size	Length (mm)	Packing	Order No.
BLPTS0148	T8	19	6	301077
BLPTS01410	T10	19	6	301078
BLPTS01415	T15	19	6	301079
BLPTS01420	T20	19	6	301080
BLPTS01425	T25	19	6	301081
BLPTS01427	T27	19	6	301082
BLPTS01430	T30	19	6	301083
BLPTS01440	T40	19	6	301084
BLPTS01445	T45	19	6	301085
BLPTS01447	T47	19	6	301086
BLPTS01450	T50	19	6	301087

- The BLPTS Series of Stubby Torx® socket drivers feature a reduced fastener depth penetration to increase strength and improve fastener engagement
- Manufactured from S2 Steel for longer tool life

## 1/4" Hex Socket Driver

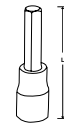

Stock No.	Size (mm)	Length (mm)	Packing	Order No.
BLPHSM0142	2	19	6	301088
BLPHSM01425	2.5	19	6	301089
BLPHSM0143	3	19	6	301090
BLPHSM0144	4	19	6	301091
BLPHSM0145	5	19	6	301092
BLPHSM0146	6	19	6	301093
BLPHSM0147	7	19	6	301094
BLPHSM0148	8	19	6	301095
BLPHSM0149	9	19	6	301096
BLPHSM01410	10	19	6	301097

- The BLPHSM Series of Stubby Hex socket drivers feature a reduced fastener depth penetration to increase strength and improve fastener engagement
- Manufactured from S2 Steel for longer tool life

## 1/4" Hex Socket Driver, Tamper Resistant

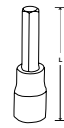

Stock No.	Size (mm)	Length (mm)	Packing	Order No.
BLPTHSM0142	2	19	6	301098
BLPTHSM01425	2.5	19	6	301099
BLPTHSM0143	3	19	6	301100
BLPTHSM0144	4	19	6	301101
BLPTHSM0145	5	19	6	301102
BLPTHSM0146	6	19	6	301103
BLPTHSM0147	7	19	6	301104
BLPTHSM0148	8	19	6	301105
BLPTHSM0149	9	19	6	301106
BLPTHSM01410	10	19	6	301107

- The BLPTHSM Series of Stubby Hex Tamper Resistant socket drivers feature a reduced fastener depth penetration to increase strength and improve fastener engagement
- Manufactured from S2 Steel for longer tool life

# Sockets, Ratchets & Accessories 1/4"

## 1/4" Phillips® Socket Driver

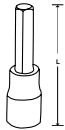

Stock No.	Size	Length (mm)		Order No.
BLPP140	#0	37	6	301108
BLPP141	#1	37	6	301109
BLPP142	#2	37	6	301110
BLPP143	#3	37	6	301111
BLPP144	#4	37	6	301112

- Manufactured from high grade steel alloy
- Features a Lifetime Warranty and exceeds ANSI Standards

## 1/4" Phillips® Socket Driver, Stubby

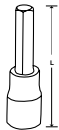

Stock No.	Size	Length (mm)		Order No.
BLPPS141	#1	19	6	301113
BLPPS142	#2	19	6	301114

- Stubby Phillips® socket drivers feature a reduced fastener depth penetration to increase strength and improve fastener engagement
- Manufactured from S2 Steel for longer tool life

## 1/4" Pozidriv® Socket Driver

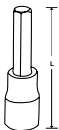

Stock No.	Size	Length (mm)		Order No.
BLPPD141	#1	37	6	301115
BLPPD142	#2	37	6	301116
BLPPD143	#3	37	6	301117

- Manufactured from high grade steel alloy
- Features a Lifetime Warranty and exceeds ANSI Standards

## 1/4" Triple Square Socket Driver

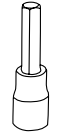

Stock No.	Size (mm)	Length (mm)		Order No.
BLPXZN144	4	27	6	301132
BLPXZN145	5	27	6	301133
BLPXZN146	6	27	6	301134
BLPXZN148	8	27	6	301135
BLPXZN1410	10	27	1	301136
BLPXZN1412	12	27	1	301137

- Manufactured from high grade steel alloy
- Features a Lifetime Warranty and exceeds ANSI Standards

## 1/4" Torx, Tamper Resistant



Stock No.	Square Drive (inches)	A			Order No.
BLPT146TP	1/4	1 7/16	T6	1	301138
BLPT147TP	1/4	1 7/16	T7	1	301139
BLPT148TP	1/4	1 7/16	T8	1	301140
BLPT149TP	1/4	1 7/16	T9	1	301141
BLPT1410TP	1/4	1 7/16	T10	1	301142
BLPT1415TP	1/4	1 7/16	T15	1	301143
BLPT1420TP	1/4	1 7/16	T20	1	301144
BLPT1425TP	1/4	1 7/16	T25	1	301145
BLPT1427TP	1/4	1 7/16	T27	1	301146
BLPT1430TP	1/4	1 7/16	T30	1	301147

- Manufactured from high grade steel alloy
- Features a Lifetime Warranty and exceeds ANSI Standards

## 1/4" Flat Tip Socket Driver, Standard

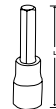

Stock No.	Size (inches)	Size (mm)	Length (mm)		Order No.
BLPFT144	5/32	4	37	6	301118
BLPFT145.5	7/32	5.5	37	6	301119
BLPFT146.5	9/32	6.5	37	6	301120

- Manufactured from high grade steel alloy
- Features a Lifetime Warranty and exceeds ANSI Standards

## 1/4" Flat Tip Socket Driver, Short

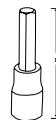

Stock No.	Size (inches)	Length (mm)		Order No.
BLPFS01414	1/4	19	1	301121
BLPFS01438	3/8	19	1	301122

- Manufactured from high grade steel alloy
- Features a Lifetime Warranty and exceeds ANSI Standards

# Sockets, Ratchets & Accessories 3/8"

## 3/8" Socket



- 1 Flank-Drive features optimal contact point and angle
- 2 Optimal heat treatment & material composition for strength & durability
- 3 Thinner walls to reach better into smaller recesses

## 3/8" Socket, mm

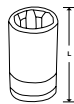

## 3/8" Long Socket, mm

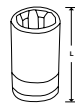

Stock No.	Size (mm)	Length (mm)	Order No.	Stock No.	Size (mm)	Length (mm)	Order No.
BLPSM386	6	25.5	302001	BLPSM3816	16	27	302011
BLPSM387	7	25.5	302002	BLPSM3817	17	27	302012
BLPSM388	8	25.5	302003	BLPSM3818	18	27	302013
BLPSM389	9	25.5	302004	BLPSM3819	19	29	302014
BLPSM3810	10	25.5	302005	BLPSM3820	20	29	302015
BLPSM3811	11	25.5	302006	BLPSM3821	21	29	302016
BLPSM3812	12	25.5	302007	BLPSM3822	22	31	302017
BLPSM3813	13	25.5	302008	BLPSM3823	23	31	302018
BLPSM3814	14	27	302009	BLPSM3824	24	31	302019
BLPSM3815	15	27	302010				

Stock No.	Size (mm)	Length (mm)	Order No.	Stock No.	Size (mm)	Length (mm)	Order No.
BLPLM386	6	64	302020	BLPLM3816	16	64	302030
BLPLM387	7	64	302021	BLPLM3817	17	64	302031
BLPLM388	8	64	302022	BLPLM3818	18	64	302032
BLPLM389	9	64	302023	BLPLM3819	19	64	302033
BLPLM3810	10	64	302024	BLPLM3820	20	64	302034
BLPLM3811	11	64	302025	BLPLM3821	21	64	302035
BLPLM3812	12	64	302026	BLPLM3822	22	64	302036
BLPLM3813	13	64	302027	BLPLM3823	23	64	302037
BLPLM3814	14	64	302028	BLPLM3824	24	64	302038
BLPLM3815	15	64	302029				

- Manufactured from high grade steel alloy
- Features a Lifetime Warranty and exceeds ANSI Standards

- Manufactured from high grade steel alloy
- Features a Lifetime Warranty and exceeds ANSI Standards

# Sockets, Ratchets & Accessories 3/8"

## 3/8" Socket, inches

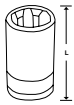

Stock No.	Size (inches)	Length (mm)	Packing	Order No.
BLPS3814	1/4	25	6	302039
BLPS38516	5/16	25	6	302040
BLPS3838	3/8	25	6	302041
BLPS38716	7/16	25	6	302042
BLPS3812	1/2	25	6	302043
BLPS38916	9/16	27	6	302044
BLPS3858	5/8	27	6	302045
BLPS381116	11/16	27	6	302046
BLPS3834	3/4	29	6	302047
BLPS381316	13/16	29	6	302048
BLPS3878	7/8	29	6	302049
BLPS381516	15/16	29	6	302050
BLPS381	1	29	6	302051

- Manufactured from high grade steel alloy
- Features a Lifetime Warranty and exceeds ANSI Standards

## 3/8" Long Socket, inches

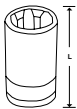

Stock No.	Size (inches)	Length (mm)	Packing	Order No.
BLPL3814	1/4	64	6	302052
BLPL38516	5/16	64	6	302053
BLPL3838	3/8	64	6	302054
BLPL38716	7/16	64	6	302055
BLPL3812	1/2	64	6	302056
BLPL38916	9/16	64	6	302057
BLPL3858	5/8	64	6	302058
BLPL381116	11/16	64	6	302059
BLPL3834	3/4	64	6	302060
BLPL381316	13/16	64	6	302061
BLPL3878	7/8	64	6	302062
BLPL381516	15/16	64	6	302063
BLPL381	1	64	6	302064

- Manufactured from high grade steel alloy
- Features a Lifetime Warranty and exceeds ANSI Standards

## 3/8" External Torx® Socket

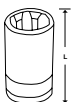

Stock No.	Size	Length (mm)	Packing	Order No.
BLPTE384	E4	31	6	302065
BLPTE385	E5	31	6	302066
BLPTE386	E6	31	6	302067
BLPTE387	E7	31	6	302068
BLPTE388	E8	31	6	302069
BLPTE3810	E10	31	6	302070
BLPTE3811	E11	31	6	302071
BLPTE3812	E12	31	6	302072
BLPTE3814	E14	31	6	302073
BLPTE3816	E16	31	6	302074
BLPTE3818	E18	31	6	302075
BLPTE3820	E20	31	6	302076

- Manufactured from high grade steel alloy
- Features a Lifetime Warranty and exceeds ANSI Standards

## 3/8" Quick Release Ratchet

BPRFR938

Order NO.: 302081

Packing: 1



Square Drive (inches)	Description	Gear Teeth
3/8	Standard Handle	38
Swing Arc	A (mm)	B (mm)
9.5°	14	33
C (mm)	Repair Kit	
197	RKRBPFR938	

- Features quick release button for rapid socket/accessory changes, even with greasy or oily hands
- Contoured handle for comfort and control
- Chrome finish for easy clean-up
- All ratchets in series meet or exceed ANSI B107-10M-1996 specifications

## 3/8" Quick Release Ratchet, Soft Grip

BPRFR938SG

Order NO.: 302082

Packing: 1



Square Drive (inches)	Description	Gear Teeth
3/8	Soft Grip Handle	38
Swing Arc	A (mm)	B (mm)
9.5°	14	33
C (mm)	Repair Kit	
197	RKRBPFR938	

- Features quick release button for rapid socket/accessory changes, even with greasy or oily hands
- Corrosive resistant bi-mold cushion grip for improved comfort and performance
- Chrome finish for easy clean-up
- All ratchets in series meet or exceed ANSI B107-10M-1996 specifications

## Finger Ratchet



Stock No.	Square Drive (inches)	Packing	Order No.
FSDR1	3/8 male-1/4 female	1	302083
FSD1	3/8 male-3/8 female	1	302084

- Reversible, finger ratchet
- Small size works great for extremely tight areas
- Aluminum knurled outer ring for sure grip



# Sockets, Ratchets & Accessories 3/8"

## 3/8" Quick Release Ratchet

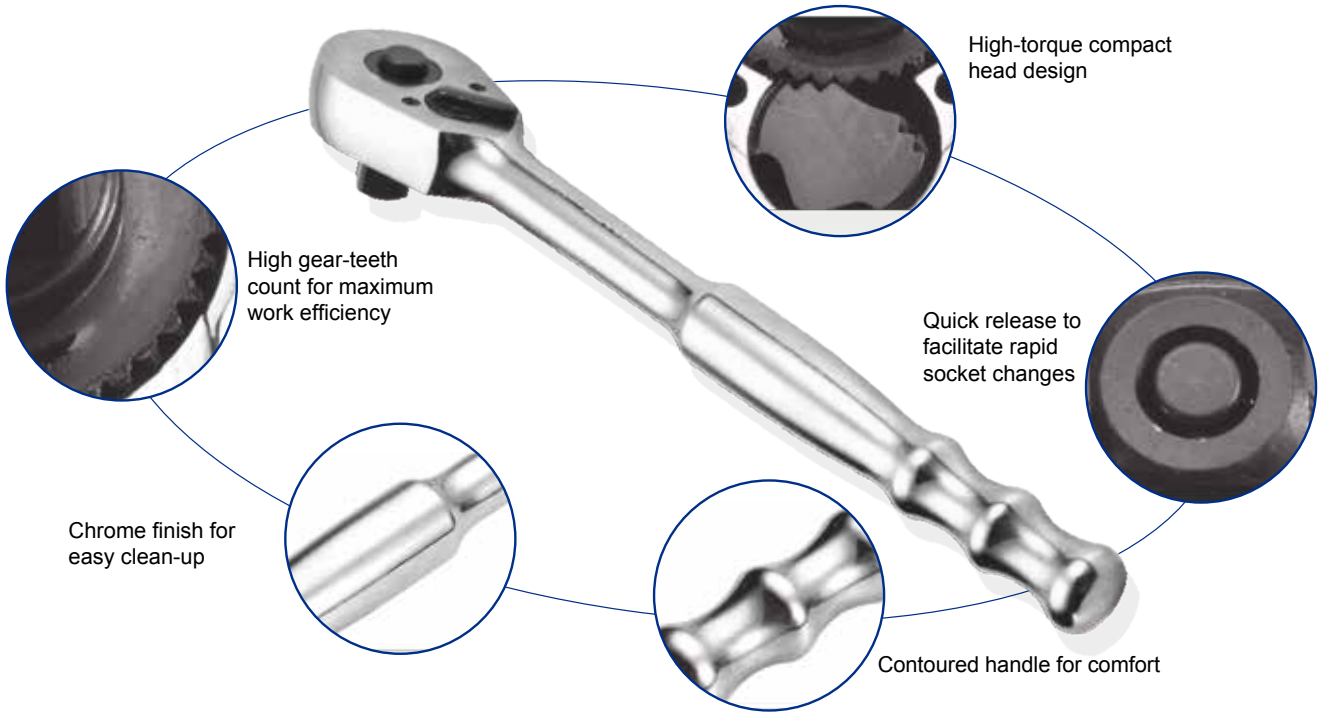

## 3/8" Universal Joint

Packing: 6

BLPUJ38

Order NO.: 302096



Stock No.	Length (mm)
BLPUJ38	52

- Manufactured from high grade steel alloy
- Features a Lifetime Warranty and exceeds ANSI Standards

## 3/8" Extension, Knurled



Stock No.	Length (mm)		Order No.
BLPEXTK383	75	6	302085
BLPEXTK386	150	6	302086
BLPEXTK3810	252	6	302087

- Manufactured from high grade steel alloy
- Features a Lifetime Warranty and exceeds ANSI Standards

## 3/8" Extension, Extra Long Locking

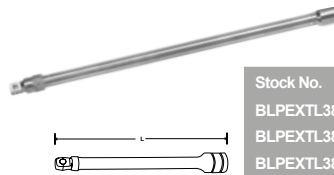

Stock No.	Length (mm)		Order No.
BLPEXTL3812	305	6	302091
BLPEXTL3818	457	6	302092
BLPEXTL3824	610	6	302093

- Manufactured from high grade steel alloy
- Features a Lifetime Warranty and exceeds ANSI Standards

## 3/8" Spark Plug Socket, mm



Stock No.	Size (mm)	Length (mm)		Order No.
BLPSPS3816	16	65	6	302077
BLPSPS3821	21	57	6	302078

## 3/8" Spark Plug Socket, inches



Stock No.	Size (inches)	Length (mm)		Order No.
BLPSPS3858	5/8	65	6	302079
BLPSPS381316	13/16	57	6	302080

- Manufactured from high grade steel alloy
- Features a Lifetime Warranty and exceeds ANSI Standards

# Sockets, Ratchets & Accessories 3/8"

## 3/8" Universal Joint

- Manufactured from high-grade alloy steel
- Offering same quality and features as our sockets with lifetime warranty



Flexible joint for more working angles

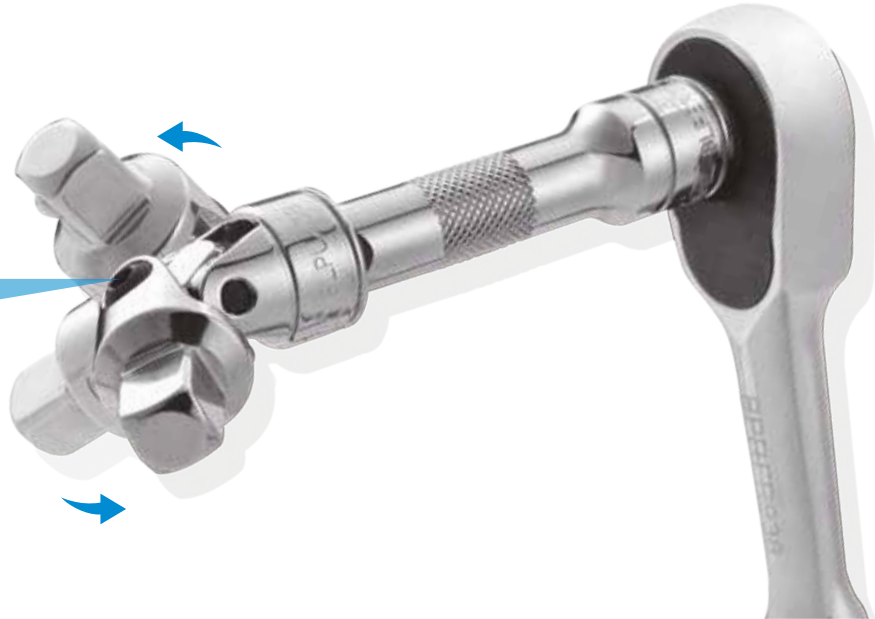

## 3/8" Sliding T-handle

Packing: 6

BLPSTHD388  
Order NO.: 302095



Stock No.	Length (mm)
BLPSTHD388	197

- Manufactured from high grade steel alloy
- Features a Lifetime Warranty and exceeds ANSI Standards

## 3/8" Locking Extension

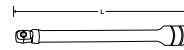

Stock No.	Length (mm)	Packing	Order No.
FXLBP3	76	6	302088
FXLBP6	152	6	302089
FXLBP10	254	6	302090

- Smooth, durable chrome finish
- Made from tough 6130 steel
- Secure socket retention
- Lifetime warranty on individual extensions

## 3/8" Adaptor



Stock No.	Internal Square Drive (inches)	External Square Drive (inches)	Packing	Order No.
BLPAFM3814	3/8	1/4	6	302097
BLPAFM3812	3/8	1/2	6	302098

- Manufactured from high grade steel alloy
- Features a Lifetime Warranty and exceeds ANSI Standards

## 3/8" Breaker Bar

Packing: 6

BLPBB3810  
Order NO.: 302094

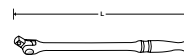

Stock No.	Length (mm)
BLPBB3810	253

- Manufactured from high grade steel alloy
- Features a Lifetime Warranty and exceeds ANSI Standards

# Sockets, Ratchets & Accessories 3/8"

## 3/8" Bit Holder

Packing: 6

BLPTMBS3814  
Order NO.: 302099



Stock No.	Length (mm)	Description
BLPTMBS3814	19	For 1/4" Hex Bits

- Manufactured from high grade steel alloy
- Features a Lifetime Warranty and exceeds ANSI Standards

## 3/8" Torx, Tamper Resistant



Stock No.	Square Drive (inches)	A	#		Order No.
BLPT3810TP	3/8	1 27/32	T10	1	302166
BLPT3815TP	3/8	1 27/32	T15	1	302167
BLPT3820TP	3/8	1 27/32	T20	1	302168
BLPT3825TP	3/8	1 27/32	T25	1	302169
BLPT3827TP	3/8	1 27/32	T27	1	302170
BLPT3830TP	3/8	1 27/32	T30	1	302171
BLPT3840TP	3/8	2	T40	1	302172
BLPT3845TP	3/8	2	T45	1	302173
BLPT3850TP	3/8	2	T50	1	302174
BLPT3855TP	3/8	2	T55	1	302155

- Manufactured from high grade steel alloy
- Features a Lifetime Warranty and exceeds ANSI Standards

## Pass Thru Socket



Stock No.	Size (mm)	Length (mm)		Order No.
BLPPTS8	8	37	6	302108
BLPPTS9	9	37	6	302109
BLPPTS10	10	37	6	302110
BLPPTS11	11	37	6	302111
BLPPTS12	12	37	6	302112
BLPPTS13	13	37	6	302113
BLPPTS14	14	37	6	302114
BLPPTS15	15	37	6	302115
BLPPTS16	16	37	6	302116
BLPPTS17	17	37	6	302117
BLPPTS18	18	37	6	302118
BLPPTS19	19	37	6	302119

- Pass thru socket design avoids "bottoming out" on long fasteners and threaded rods
- Sockets can reach fasteners in tight spaces with relative ease

## Pass Thru Socket



Stock No.	Size (inches)	Length (mm)		Order No.
BLPPTS38	3/8	37	6	302101
BLPPTS716	7/16	37	6	302102
BLPPTS12	1/2	37	6	302103
BLPPTS916	9/16	37	6	302104
BLPPTS58	5/8	37	6	302105
BLPPTS1116	11/16	37	6	302106
BLPPTS34	3/4	37	6	302107

- Pass thru socket design avoids "bottoming out" on long fasteners and threaded rods
- Sockets can reach fasteners in tight spaces with relative ease

## 3/8" Torx® Socket Driver



Stock No.	Size	Length (mm)		Order No.
BLPTS3810	T10	48	6	302123
BLPTS3815	T15	48	6	302124
BLPTS3820	T20	48	6	302125
BLPTS3825	T25	48	6	302126
BLPTS3827	T27	48	6	302127
BLPTS3830	T30	48	6	302128
BLPTS3840	T40	51	6	302129
BLPTS3845	T45	51	6	302130
BLPTS3850	T50	51	6	302131
BLPTS3855	T55	51	6	302132
BLPTS3860	T60	51	6	302133

- Manufactured from high grade steel alloy
- Features a Lifetime Warranty and exceeds ANSI Standards

## 3/8" Phillips® Socket Driver



Stock No.	Size	Length (mm)		Order No.
BLPP381	#1	47	6	302141
BLPP382	#2	47	6	302142
BLPP383	#3	47	6	302143
BLPP384	#4	47	6	302144

- Manufactured from high grade steel alloy
- Features a Lifetime Warranty and exceeds ANSI Standards

# Sockets, Ratchets & Accessories 3/8"

## 3/8" Pozidriv® Socket Driver

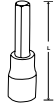

Stock No.	Size	Length (mm)	Packing	Order No.
BLPPD381	#1	47	6	302145
BLPPD382	#2	47	6	302146
BLPPD383	#3	47	6	302147
BLPPD384	#4	47	6	302148

- Manufactured from high grade steel alloy
- Features a Lifetime Warranty and exceeds ANSI Standards

## 3/8" Flat Socket Driver

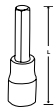

Stock No.	Size (mm)	Length (mm)	Packing	Order No.
BLPFT3855	5.5	47	6	302149
BLPFT3865	6.5	47	6	302150
BLPFT388	8	47	6	302151

- Manufactured from high grade steel alloy
- Features a Lifetime Warranty and exceeds ANSI Standards

## Pass Thru Ratchet

Packing: 6

BPRFPT10  
Order NO.: 302120

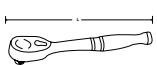

Stock No.	Length (mm)
BPRFPT10	254

- Ratchet features a flex head design that allows for seven different locking positions

## Pass Thru Extension

Packing: 6

BLPPTEXT3  
Order NO.: 302121

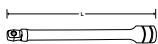

Stock No.	Length (mm)
BLPPTEXT3	76

- 3" extension
- 3/8" drive

## 3/8" Square Drive Pass Thru Adapter

Packing: 6

BLPPTA3438  
Order NO.: 302122



Stock No.	Length (mm)
BLPPTA3438	32

- Manufactured from high grade steel alloy
- Features a Lifetime Warranty and exceeds ANSI Standards

## 3/8" Spinner Handle

Packing: 6

BLPCGHD388  
Order NO.: 302100

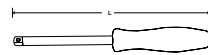

Stock No.	Length (mm)
BLPCGHD388	219

- Manufactured from high grade steel alloy
- Features a Lifetime Warranty and exceeds ANSI Standards

## 3/8" Hex Socket Driver

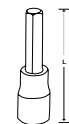

Stock No.	Size (mm)	Length (mm)	Packing	Order No.
BLPH383	3	47	6	302134
BLPH384	4	47	6	302135
BLPH385	5	47	6	302136
BLPH386	6	47	6	302137
BLPH387	7	47	6	302138
BLPH388	8	50.5	6	302139
BLPH3810	10	50.5	6	302140

- Manufactured from high grade steel alloy
- Features a Lifetime Warranty and exceeds ANSI Standards

## 3/8" Triple Square Socket Driver

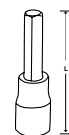

Stock No.	Size	Length (mm)	Packing	Order No.
BLPXZNM0384	M4	27	6	302157
BLPXZNM0385	M5	27	6	302158
BLPXZNM0386	M6	27	6	302159
BLPXZNM0388	M8	27	6	302160
BLPXZNM03810	M10	27	6	302161
BLPXZNM03812	M12	27	6	302162

- Manufactured from high grade steel alloy
- Features a Lifetime Warranty and exceeds ANSI Standards

# Sockets, Ratchets & Accessories 1/2"

## 1/2" Socket, mm

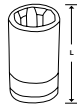

Stock No.	Size (mm)	Length (mm)	Order No.	Stock No.	Size (mm)	Length (mm)	Order No.
BLPSM128	8	38	303001	BLPSM1219	19	38	303012
BLPSM129	9	38	303002	BLPSM1220	20	38	303013
BLPSM1210	10	38	303003	BLPSM1221	21	38	303014
BLPSM1211	11	38	303004	BLPSM1222	22	38	303015
BLPSM1212	12	38	303005	BLPSM1223	23	38	303016
BLPSM1213	13	38	303006	BLPSM1224	24	38	303017
BLPSM1214	14	38	303007	BLPSM1227	27	38	303018
BLPSM1215	15	38	303008	BLPSM1230	30	38	303019
BLPSM1216	16	38	303009	BLPSM1232	32	38	303020
BLPSM1217	17	38	303010	BLPSM1234	34	38	303021
BLPSM1218	18	38	303011	BLPSM1236	36	38	303022

- Manufactured from high grade steel alloy
- Features a Lifetime Warranty and exceeds ANSI Standards

## 1/2" Long Socket, mm

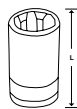

Stock No.	Size (mm)	Length (mm)	Order No.	Stock No.	Size (mm)	Length (mm)	Order No.
BLPLM1210	10	76	303023	BLPLM1219	19	76	303032
BLPLM1211	11	76	303024	BLPLM1220	20	76	303033
BLPLM1212	12	76	303025	BLPLM1221	21	76	303034
BLPLM1213	13	76	303026	BLPLM1222	22	76	303035
BLPLM1214	14	76	303027	BLPLM1224	24	76	303036
BLPLM1215	15	76	303028	BLPLM1227	27	76	303037
BLPLM1216	16	76	303029	BLPLM1230	30	76	303038
BLPLM1217	17	76	303030	BLPLM1232	32	76	303039
BLPLM1218	18	76	303031				

- Manufactured from high grade steel alloy
- Features a Lifetime Warranty and exceeds ANSI Standards

## 1/2" Socket, inches

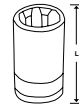

Stock No.	Size (inches)	Length (mm)	Order No.	Stock No.	Size (inches)	Length (mm)	Order No.
BLPS12516	5/16	38	303040	BLPS121316	13/16	38	303048
BLPS1238	3/8	38	303041	BLPS1278	7/8	38	303049
BLPS12716	7/16	38	303042	BLPS121516	15/16	40	303050
BLPS1212	1/2	38	303043	BLPS121	1	40	303051
BLPS12916	9/16	38	303044	BLPSB121116	1 1/16	40	303052
BLPS1258	5/8	38	303045	BLPSB12118	1 1/8	44	303053
BLPS121116	11/16	38	303046	BLPSB121316	1 3/16	44	303054
BLPS1234	3/4	38	303047	BLPSB12114	1 1/4	44	303055

- Manufactured from high grade steel alloy
- Features a Lifetime Warranty and exceeds ANSI Standards

## 1/2" Long Socket, inches

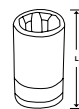

Stock No.	Size (inches)	Length (mm)	Order No.	Stock No.	Size (inches)	Length (mm)	Order No.
BLPL1238	3/8	76	303056	BLPL121316	13/16	76	303063
BLPL12716	7/16	76	303057	BLPL1278	7/8	76	303064
BLPL1212	1/2	76	303058	BLPL121516	15/16	76	303065
BLPL12916	9/16	76	303059	BLPL121	1	76	303066
BLPL1258	5/8	76	303060	BLPLB121116	1 1/16	76	303067
BLPL121116	11/16	76	303061	BLPLB12118	1 1/8	76	303068
BLPL1234	3/4	76	303062	BLPLB125114	1 1/4	76	303069

- Manufactured from high grade steel alloy
- Features a Lifetime Warranty and exceeds ANSI Standards



WARNING



• Do not use chrome or industrial finish hand tools with impact drivers  
• Read safety precautions on page 162

# Sockets, Ratchets & Accessories 1/2"

## 1/2" Double Hex Socket, mm

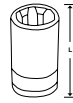

Stock No.	Size (mm)	Length (mm)	Order No.	Stock No.	Size (mm)	Length (mm)	Order No.
BLPDM128	8	38	6 303070	BLPDM1218	18	38	6 303080
BLPDM129	9	38	6 303071	BLPDM1219	19	38	6 303081
BLPDM1210	10	38	6 303072	BLPDM1220	20	38	6 303082
BLPDM1211	11	38	6 303073	BLPDM1221	21	38	6 303083
BLPDM1212	12	38	6 303074	BLPDM1222	22	38	6 303084
BLPDM1213	13	38	6 303075	BLPDM1223	23	38	6 303085
BLPDM1214	14	38	6 303076	BLPDM1224	24	38	6 303086
BLPDM1215	15	38	6 303077	BLPDM1227	27	38	6 303087
BLPDM1216	16	38	6 303078	BLPDM1230	30	38	6 303088
BLPDM1217	17	38	6 303079	BLPDM1232	32	38	6 303089

- Manufactured from high grade steel alloy
- Features a Lifetime Warranty and exceeds ANSI Standards

## 1/2" Double Hex Socket, inches

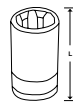

Stock No.	Size (inches)	Length (mm)	Order No.	Stock No.	Size (inches)	Length (mm)	Order No.
BLPD12516	5/16	38	6 303090	BLPD121316	13/16	38	6 303098
BLPD1238	3/8	38	6 303091	BLPD1278	7/8	41	6 303099
BLPD12716	7/16	38	6 303092	BLPD121516	15/16	41	6 303100
BLPD1212	1/2	38	6 303093	BLPD121	1	41	6 303101
BLPD12916	9/16	38	6 303094	BLPDB121116	1 1/16	44	6 303102
BLPD1258	5/8	38	6 303095	BLPDB12118	1 1/8	44	6 303103
BLPD121116	11/16	38	6 303096	BLPDB12114	1 1/4	44	6 303104
BLPD1234	3/4	38	6 303097				

- Manufactured from high grade steel alloy
- Features a Lifetime Warranty and exceeds ANSI Standards

## 1/2" External Torx® Socket



Stock No.	Size	Length (mm)	Order No.
BLPTE1210	E10	38	6 303105
BLPTE1212	E12	38	6 303106
BLPTE1214	E14	38	6 303107
BLPTE1216	E16	38	6 303108
BLPTE1218	E18	38	6 303109
BLPTE1220	E20	38	6 303110
BLPTE1222	E22	38	6 303111
BLPTE1224	E24	38	6 303112

- Manufactured from high grade steel alloy
- Features a Lifetime Warranty and exceeds ANSI Standards

## 1/2" Quick Release Ratchet

BPRSR940

Packing: 1

Order NO.: 303117

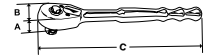

Square Drive (inches)	Description	Gear Teeth
1/2	Standard Handle	40
Swing Arc	A (mm)	B (mm)
9°	18	44
C (mm)	Repair Kit	
251	RKRBPBPRSR940	

- Features quick release button for rapid socket/accessory changes, even with greasy or oily hands
- Contoured handle for comfort and control
- Chrome finish for easy clean-up
- All ratchets in series meet or exceed ANSI B107-10M-1996 specifications

## 1/2" Torx, Tamper Resistant



Stock No.	Square Drive (inches)	A	#	Order No.
BLPT1255TP	1/2	2 5/16	T55	1 303185
BLPT1260TP	1/2	2 5/16	T60	1 303186

- Manufactured from high grade steel alloy
- Features a Lifetime Warranty and exceeds ANSI Standards

# Sockets, Ratchets & Accessories 1/2"

## 1/2" Spark Plug Socket, mm

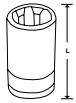

Stock No.	Size (mm)	Length (mm)		Order No.
BLPSPS1216	16	65	6	303113
BLPSPS1221	21	57	6	303114

- Manufactured from high grade steel alloy
- Features a Lifetime Warranty and exceeds ANSI Standards

## 1/2" Spark Plug Socket, inches

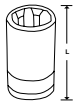

Stock No.	Size (inches)	Length (mm)		Order No.
BLPSPS1258	5/8	65	6	303115
BLPSPS121316	13/16	57	6	303116

- Manufactured from high grade steel alloy
- Features a Lifetime Warranty and exceeds ANSI Standards

## 1/2" Quick Release Ratchet, Soft Grip

Packing: 1

BPRSR940SG  
Order NO.: 303118

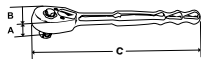

Square Drive (inches)	Description	Gear Teeth
1/2	Soft Grip Handle	40
	Swing Arc	A (mm) B (mm)
	9°	18 44
	C (mm)	Repair Kit
	103	RKRBPRSR940

## 1/2" Extension Knurled

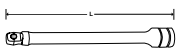

Stock No.	Length (mm)		Order No.
BLPEXTK123	76	6	303119
BLPEXTK125	127	6	303120
BLPEXTK126	152	6	303121
BLPEXTK1210	254	6	303122

## 1/2" Locking Extension

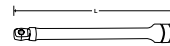

Stock No.	Length (mm)		Order No.
SXLBP3	76	6	303123
SXLBP6	152	6	303124
SXLBP10	254	6	303125

- Manufactured from high grade steel alloy
- Features a Lifetime Warranty and exceeds ANSI Standards

## 1/2" Sliding T-handle

Packing: 6

BLPSTHD1215  
Order NO.: 303129

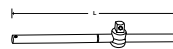

Stock No.	Length (mm)
BLPSTHD1215	381

- Manufactured from high grade steel alloy
- Features a Lifetime Warranty and exceeds ANSI Standards

## 1/2" Universal Joint

Packing: 6

BLPUJ12  
Order NO.: 303130



Stock No.	Length (mm)
BLPUJ12	70

- Manufactured from high grade steel alloy
- Features a Lifetime Warranty and exceeds ANSI Standards

## 1/2" Adaptor

Packing: 6

BLPAFM1238  
Order NO.: 303131



Stock No.	Internal Square Drive (inches)	External Square Drive (inches)
BLPAFM1238	1/2	3/8

- Manufactured from high grade steel alloy
- Features a Lifetime Warranty and exceeds ANSI Standards

# Sockets, Ratchets & Accessories 1/2"

## 1/2" Sliding Head

Packing: 6

BLPSH1238  
Order NO.: 303132



Stock No.	Length (mm)
BLPSH1238	37

- Manufactured from high grade steel alloy
- Features a Lifetime Warranty and exceeds ANSI Standards

## 1/2" Speeder

Packing: 6

BLPS12  
Order NO.: 303133



Stock No.	Length (mm)
BLPS12	457

- Manufactured from high grade steel alloy
- Features a Lifetime Warranty and exceeds ANSI Standards

## 1/2" Hex Socket Driver

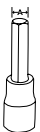

Stock No.	Size (mm)	Length (mm)	Packing	Order No.
BLPH123	3	36.5	6	303143
BLPH124	4	36.5	6	303144
BLPH125	5	36.5	6	303145
BLPH126	6	36.5	6	303146
BLPH127	7	36.5	6	303147
BLPH128	8	36.5	6	303148
BLPH1210	10	36.5	6	303149
BLPH1212	12	36.5	6	303150
BLPH1214	14	36.5	6	303151
BLPH1217	17	36.5	6	303152
BLPH1219	19	36.5	6	303153
BLPH125L180	5	180	6	303154
BLPH126L70	6	70	6	303155
BLPH126L140	6	140	6	303156
BLPH126L250	6	250	6	303157
BLPH128L120	8	120	6	303158
BLPH1210L140	10	140	6	303159

- Manufactured from high grade steel alloy
- Features a Lifetime Warranty and exceeds ANSI Standards

## 1/2" Torx® Socket Driver



Stock No.	Size	Length (mm)	Packing	Order No.
BLPT1220	T20	37	6	303134
BLPT1225	T25	37	6	303135
BLPT1227	T27	37	6	303136
BLPT1230	T30	37	6	303137
BLPT1240	T40	37	6	303138
BLPT1245	T45	37	6	303139
BLPT1250	T50	37	6	303140
BLPT1255	T55	37	6	303141
BLPT1260	T60	37	6	303142

- Manufactured from high grade steel alloy
- Features a Lifetime Warranty and exceeds ANSI Standards

## 1/2" Breaker Bar

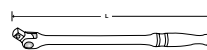

Stock No.	Length (mm)	Packing	Order No.
BLPBB1210	254	6	303126
BLPBB1215	381	6	303127
BLPBB1224	605	6	303128

- Manufactured from high grade steel alloy
- Features a Lifetime Warranty and exceeds ANSI Standards

## 1/2" Triple Square Socket Driver

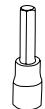

Stock No.	Size (inches)	Length (mm)	Packing	Order No.
BLPXZNM125	M5	37	6	303160
BLPXZNM126	M6	37	6	303161
BLPXZNM128	M8	37	6	303162
BLPXZNM1210	M10	37	6	303163
BLPXZNM1212	M12	37	6	303164
BLPXZNM1214	M14	37	6	303165
BLPXZNM1216	M16	37	6	303166

- Manufactured from high grade steel alloy
- Features a Lifetime Warranty and exceeds ANSI Standards

## 1/2" Long Torx® Socket Driver

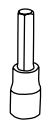

Stock No.	Size	Length (mm)	Packing	Order No.
BLPTL1220	T20	100	6	303167
BLPTL1225	T25	100	6	303168
BLPTL1227	T27	100	6	303169
BLPTL1230	T30	100	6	303170
BLPTL1240	T40	100	6	303171
BLPTL1245	T45	100	6	303172
BLPTL1250	T50	100	6	303173
BLPTL1255	T55	100	6	303174
BLPTL1260	T60	100	6	303175



# Sockets, Ratchets & Accessories 1/2" / 3/4"

## 1/2" Long Hex Socket Driver

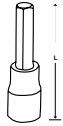

Stock No.	Size (mm)	Length (mm)		Order No.
BLPHL124	4	100	6	303176
BLPHL125	5	100	6	303177
BLPHL126	6	100	6	303178
BLPHL127	7	100	6	303179
BLPHL128	8	100	6	303180
BLPHL1210	10	100	6	303181
BLPHL1212	12	100	6	303182
BLPHL1214	14	100	6	303183
BLPHL1217	17	100	6	303184

- Manufactured from high grade steel alloy
- Features a Lifetime Warranty and exceeds ANSI Standards

## 3/4" Double Hex Socket

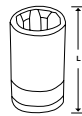

Stock No.	Size (mm)	Length (mm)		Order No.	Stock No.	Size (mm)	Length (mm)		Order No.
BLPDM3419	19	47	6	304001	BLPDM3432	32	58	6	304012
BLPDM3421	21	47	6	304002	BLPDM3433	33	60	6	304013
BLPDM3422	22	47	6	304003	BLPDM3434	34	60	6	304014
BLPDM3423	23	50	6	304004	BLPDM3435	35	60	6	304015
BLPDM3424	24	50	6	304005	BLPDM3436	36	63	6	304016
BLPDM3425	25	53	6	304006	BLPDM3438	38	63	6	304017
BLPDM3426	26	53	6	304007	BLPDM3441	41	66	6	304018
BLPDM3427	27	53	6	304008	BLPDM3446	46	68	6	304019
BLPDM3428	28	53	6	304009	BLPDM3450	50	68	6	304020
BLPDM3429	29	53	6	304010	BLPDM3455	55	69	6	304021
BLPDM3430	30	58	6	304011	BLPDM3460	60	72	6	304022

- Manufactured from high grade steel alloy
- Features a Lifetime Warranty and exceeds ANSI Standards

## 3/4" Quick Release Ratchet

Packing: 6

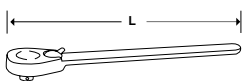

Stock No.	Square Drive (inches)	Length (mm)
BPRSR942	3/4	508

BPRSR942  
Order NO.: 304023

- Features quick release button for rapid socket/accessory changes, even with greasy or oily hands
- Contoured handle for comfort and control
- Chrome finish for easy clean-up
- All ratchets in series meet or exceed ANSI B107-10M-1996 specifications

## 3/4" Extension

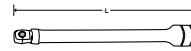

Stock No.	Length (mm)		Order No.
BLPEXT344	102	6	304024
BLPEXT348	203	6	304025
BLPEXT3416	406	6	304026

- Manufactured from high grade steel alloy
- Features a Lifetime Warranty and exceeds ANSI Standards

## 3/4" Universal Joint

Packing: 6

BLPUJ34  
Order NO.: 304029

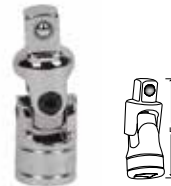

Stock No.	Length (mm)
BLPUJ34	110

- Manufactured from high grade steel alloy
- Features a Lifetime Warranty and exceeds ANSI Standards

## 3/4" Breaker Bar

Packing: 6

BLPBB3419  
Order NO.: 304028

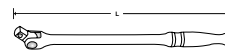

Stock No.	Length (mm)
BLPBB3419	483

- Manufactured from high grade steel alloy
- Features a Lifetime Warranty and exceeds ANSI Standards

## 3/4" Sliding T-handle

Packing: 6

BLPSTHD3418  
Order NO.: 304027

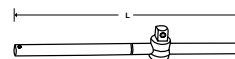

Stock No.	Length (mm)
BLPSTHD3418	457

- Manufactured from high grade steel alloy
- Features a Lifetime Warranty and exceeds ANSI Standards

## 3/4" L-Shape Wrench

Packing: 6

BLPLW3415  
Order NO.: 304030

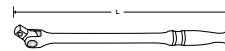

Stock No.	Length (mm)
BLPLW3415	381

- Manufactured from high grade steel alloy
- Features a Lifetime Warranty and exceeds ANSI Standards



# WRENCHES



Wrench Sets

40

Adjustable Wrenches

42

Combination Wrenches

43

Double Open End Wrenches

43

Offset Box Wrenches

44

Ratcheting Wrenches

44

L and T shape Wrenches

47

Other Wrenches

47



The first of Blue-Point wrenches were designed to be unbreakable at its head, unable to spread its jaws or bend its handle, and cannot injure them nor destroy their everlasting efficiency. While most of our wrenches have evolved and improved with time, these core philosophies to quality are observed till today in our design.

Our ratcheting wrench uses gears with higher number of teeth so that you need less swings to tighten and loosen a fastener. In short, you work less to get each job done.

We kept the thickness of the jaws to the minimal without losing its required strength. This allows our wrench to reach better into constricted openings for any tightening or loosening task.

Flexible head is also incorporated into some designs to accommodate awkward working angles.

The ends of our wrench are set in an optimal angle so that you can flip it to get the best working angle.

Nickel chrome exterior finishes the wrench for corrosion resistance and a durable tool.



# Wrenches Wrench Sets

## Adjustable Wrench Set, 4pcs

Packing: 4



- Includes GAJ6A (6"), GAJ8A (8"), GAJ10A (10") and GAJ12A (12") adjustable wrenches

BLPADJ404  
Order NO.: 401001

## Adjustable Wrench Set, 3pcs

Packing: 3



- Includes GAJ15A (15"), GAJ18A (18") and GAJ24A (24") adjustable wrenches

BLPADJ703  
Order NO.: 401002

## Adjustable Wrench Set, 3pcs

Packing: 1



- Includes BADJC6 (6"), BADJC8 (8") and BADJC10 (10") composite handle adjustable wrenches

BADJC703  
Order NO.: 401003

## Adjustable Wrench Set, 4pcs

Packing: 4



- Includes GAJ6SG (6"), GAJ8SG (8"), GAJ10SG (10") and GAJ12SG (12") adjustable wrenches

BLPADJ404SG  
Order NO.: 401004

## Ratcheting Wrench Set



Stock No.		Order No.
BOER708	1	401009
BOER704	1	401010

### BOER708

- Includes 5/16" to 3/4" ratchet combination wrenches

BOER10 BOER18  
BOER12 BOER20  
BOER14 BOER22  
BOER16 BOER24

### BOER704

- Includes BOER26, BOER28, BOER30 and BOER32 (13/16" to 1") ratchet combination wrenches

## Ratcheting Wrench Set



Stock No.		Order No.
BOERM712	1	401007
BOERM704	1	401008

### BOERM712

- Includes 8 to 19mm ratchet combination wrenches

BOERM8 BOERM12 BOERM16  
BOERM9 BOERM13 BOERM17  
BOERM10 BOERM14 BOERM18  
BOERM11 BOERM15 BOERM19

### BOERM704

- Includes BOERM21, BOERM22, BOERM24 and BOERM25 (21 to 25mm) ratchet combination wrenches

# Wrenches Wrench Sets

## Ratcheting Wrench Set, 12pcs

Packing: 1

BOERMF712A  
Order NO.: 401011



- Includes 8 to 19mm flexible head ratchet combination wrenches

BOERMF8A BOERMF12A BOERMF16A  
BOERMF9A BOERMF13A BOERMF17A  
BOERMF10A BOERMF14A BOERMF18A  
BOERMF11A BOERMF15A BOERMF19A

## Ratcheting Wrench Set, 8pcs

Packing: 1

BOERS708  
Order NO.: 401014



- Includes 5/16" to 3/4" short ratchet combination wrenches

BOERS10 BOERS18  
BOERS12 BOERS20  
BOERS14 BOERS22  
BOERS16 BOERS24

## Ratcheting Wrench Set, 12pcs

Packing: 1

BOERMS712  
Order NO.: 401013



- Includes 8 to 19mm short ratchet combination wrenches

BOERMS8 BOERMS12 BOERMS16  
BOERMS9 BOERMS13 BOERMS17  
BOERMS10 BOERMS14 BOERMS18  
BOERMS11 BOERMS15 BOERMS19

## Ratcheting Wrench Set, 8pcs

Packing: 1

BOERSF708  
Order NO.: 401016



- Includes 5/16" to 3/4" short flexible head ratchet combination wrenches

BOERSF10 BOERSF18  
BOERSF12 BOERSF20  
BOERSF14 BOERSF22  
BOERSF16 BOERSF24

## Ratcheting Wrench Set, 8pcs

Packing: 1

BOERF708A  
Order NO.: 401012



- Includes 5/16" to 3/4" flexible head ratchet combination wrenches

BOERF10A BOERF18A  
BOERF12A BOERF20A  
BOERF14A BOERF22A  
BOERF16A BOERF24A

## Ratcheting Wrench Set, 12pcs

Packing: 1

BOERMFLCG712  
Order NO.: 401017



- Includes 8 to 19mm locking flexible head ratchet combination wrenches

BOERMFLCG8 BOERMFLCG12 BOERMFLCG16  
BOERMFLCG9 BOERMFLCG13 BOERMFLCG17  
BOERMFLCG10 BOERMFLCG14 BOERMFLCG18  
BOERMFLCG11 BOERMFLCG15 BOERMFLCG19

## Flexible Head Ratchet Combination Wrench

- High strength with minimal bulkiness
- Highly polished and smooth surface for comfort
- Durable and tough nickel chrome finish
- Flexible head to work in better angles
- High ratcheting gear teeth count for better work efficiency

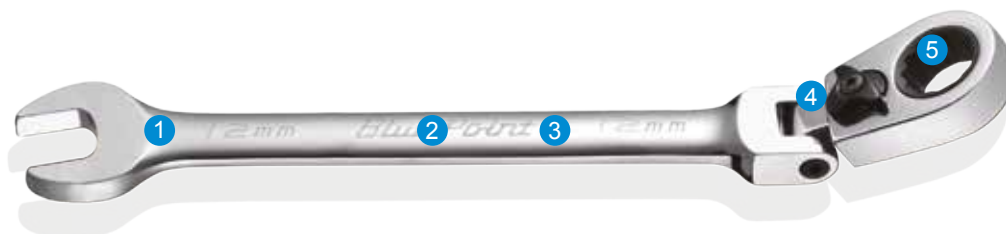

# Wrenches Wrench Sets / Adjustable Wrenches

## Ratcheting Wrench Set, 8pcs

Packing: 1



- Includes 5/16" to 3/4" locking flexible head ratchet combination wrenches

BOERFLCG10 BOERFLCG18  
BOERFLCG12 BOERFLCG20  
BOERFLCG14 BOERFLCG22  
BOERFLCG16 BOERFLCG24

BOERFLCG708  
Order NO.: 401018

## L-Shape Hex Keys Wrench Set, 9pcs

Packing: 1



Stock No.	mm	A (mm)	L (mm)	Packing	Order No.
BLWM1.5	1.5	13.5	77	6	407022
BLWM2	2	15.5	82	6	407023
BLWM2.5	2.5	17.5	88.5	6	407024
BLWM3	3	19	98.5	6	407025
BLWM4	4	24	104	6	407026
BLWM5	5	27	116	6	407027
BLWM6	6	31	138	6	407028
BLWM8	8	35	158	6	407029
BLWM10	10	39	167	6	407030

- Set includes 1.5-2-2.5-3-4-5-6-8-10mm in plastic holder
- Made from high torque steel
- Ball hex allows angle entry

BLWSM9  
Order NO: 407001

## Ratcheting Box Wrench Set, 5pcs

Packing: 1



- Includes 7-8 to 15-17mm ratcheting box wrenches

RBZM78 RBZM1314 RBZM910  
RBZM1517 RBZM1112

RBZM605  
Order NO.: 401019

## L-Shape Torx Wrench Set, 9pcs

Packing: 1



#	A (mm)	L (mm)	#	A (mm)	L (mm)
T10	17	86	T30	24	114
T15	18	90	T40	26	124
T20	19	95	T45	29	133
T25	20	100	T50	32	152
T27	21	105			

- Includes T10-T15-T20-T25-T27-T30-T40-T45-T50 in plastic holder
- Made from high torque steel

BLWTS9  
Order NO.: 407006

## Ratcheting Box Wrench Set, 5pcs

Packing: 1



- Includes 1/4" - 5/16" to 3/4" - 7/8" ratcheting box wrenches

RBZ810 RBZ1214 RBZ1618

RBZ605  
Order NO.: 401020

## Adjustable



Stock No.*	A (mm)	L (mm)	Packing	Order No.	Stock No.*	A (mm)	L (mm)	Packing	Order No.
GAJ4A	13	108	6	402001	GAJ15A	43	385	4	402006
GAJ6A	25	160	6	402002	GAJ18A	52	450	2	402007
GAJ8A	29	210	6	402003	GAJ24A	62	610	1	402008
GAJ10A	33	260	6	402004	GAJS30A	85	778	1	402009
GAJ12A	38	310	6	402005					

\*For China & India

Stock No.**	A (mm)	L (mm)	Packing	Order No.	Stock No.**	A (mm)	L (mm)	Packing	Order No.
GAJ4AP	13	108	6	402017	GAJ15AP	43	385	4	402022
GAJ6AP	25	160	6	402018	GAJ18AP	52	450	2	402023
GAJ8AP	29	210	6	402019	GAJ24AP	62	610	1	402024
GAJ10AP	33	260	6	402020	GAJS30AP	85	778	1	402025
GAJ12AP	38	310	6	402021					

\*\*For Rest of Asia

- Wrench features a durable black phosphate finish
- Wide-open jaw design with polished head
- Heat treated steel alloy construction
- Inch scale laser etched on head face

# Wrenches Adjustable / Combination / Double Open End Wrenches

## Adjustable, Composite Grip



Stock No.*	A (mm)	L (mm)	Order No.	Stock No.**	A (mm)	L (mm)	Order No.
BADJC6	25	164	402010	BADJC6AP	25	164	402026
BADJC8	30	218	402011	BADJC8AP	30	218	402027
BADJC10	35	267	402012	BADJC10AP	35	267	402028

\*For China & India

\*\*For Rest of Asia

- Ergonomic, lightweight handle design reduces fatigue while providing easier gripping and greater balance
- Inch scale is laser etched on face
- Fully polished head
- Durable heat treated alloy construction

## Adjustable, Soft Grip



Stock No.*	A(mm)	L (mm)	Order No.
GAJ6SG	25	160	402013
GAJ8SG	29	210	402014
GAJ10SG	33	260	402015
GAJ12SG	38	310	402016

\*For China & India

Stock No.**	A(mm)	L (mm)	Order No.
GAJ6SGAP	25	160	402029
GAJ8SGAP	29	210	402030
GAJ10SGAP	33	260	402031
GAJ12SGAP	38	310	402032

\*\*For Rest of Asia

- Now the most popular Blue-Point® Adjustable Wrenches are available with soft grips
- Durable black phosphate finish
- Wide open jaw design with oversized capacity
- Laser-etched SAE/metric scale for easy determination of bolt size
- Soft Grip design for added comfort

## Combination, Long

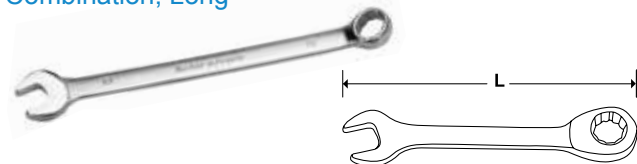

Stock No.	mm	L (mm)	Order No.
BLPCWM36	36	432	403023
BLPCWM38	38	432	403024
BLPCWM41	41	445	403025
BLPCWM46	46	483	403026

- Manufactured from high grade steel alloy
- Features a Lifetime Warranty and exceeds ANSI Standards

## Combination, Regular

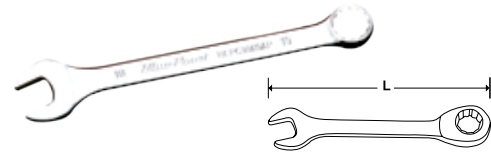

Stock No.	mm	L (mm)	Order No.	Stock No.	mm	L (mm)	Order No.
BLPCWM6AP	6	104	403040	BLPCWM20AP	20	239	403054
BLPCWM7AP	7	110	403041	BLPCWM21AP	21	249.8	403055
BLPCWM8AP	8	120	403042	BLPCWM22AP	22	249.8	403056
BLPCWM9AP	9	125	403043	BLPCWM23AP	23	269	403057
BLPCWM10AP	10	135	403044	BLPCWM24AP	24	269	403058
BLPCWM11AP	11	144	403045	BLPCWM25AP	25	290	403059
BLPCWM12AP	12	155	403046	BLPCWM26AP	26	290	403060
BLPCWM13AP	13	165	403047	BLPCWM27AP	27	310	403061
BLPCWM14AP	14	175	403048	BLPCWM28AP	28	330	403062
BLPCWM15AP	15	184	403049	BLPCWM29AP	29	330	403063
BLPCWM16AP	16	195	403050	BLPCWM30AP	30	330	403064
BLPCWM17AP	17	204	403051	BLPCWM32AP	32	350	403065
BLPCWM18AP	18	215	403052	BLPCWM34AP	34	350	403066
BLPCWM19AP	19	229	403053				

- Manufactured from high grade steel alloy
- Features a Lifetime Warranty and exceeds ANSI Standards
- New high polish

## Double Open End



Stock No.	mm	L (mm)	Order No.	Stock No.	mm	L (mm)	Order No.
BDOEM67	6-7	125	404001	BDOEM1719	17-19	225	404014
BDOEM68	6-8	125	404002	BDOEM1819	18-19	225	404015
BDOEM89	8-9	135	404003	BDOEM1921	19-21	237	404016
BDOEM810	8-10	135	404004	BDOEM1922	19-22	237	404017
BDOEM1011	10-11	145	404005	BDOEM2022	20-22	255	404018
BDOEM1012	10-12	145	404006	BDOEM2123	21-23	255	404019
BDOEM1113	11-13	165	404007	BDOEM2224	22-24	255	404020
BDOEM1213	12-13	165	404008	BDOEM2326	23-26	295	404021
BDOEM1214	12-14	165	404009	BDOEM2426	24-26	295	404022
BDOEM1314	13-14	165	404010	BDOEM2427	24-27	295	404023
BDOEM1415	14-15	185	404011	BDOEM2528	25-28	334	404024
BDOEM1417	14-17	185	404012	BDOEM3032	30-32	368	404025
BDOEM1617	16-17	185	404013				

Stock No.	mm	L (Inches)	Order No.
BDOE1012	$\frac{5}{16}$ - $\frac{3}{8}$	5 $\frac{5}{16}$	404026
BDOE1416	$\frac{7}{16}$ - $\frac{1}{2}$	6 $\frac{1}{2}$	404027
BDOE1820	$\frac{9}{16}$ - $\frac{5}{8}$	7 $\frac{9}{32}$	404028
BDOE2224	$\frac{11}{16}$ - $\frac{3}{4}$	8 $\frac{15}{16}$	404029

- Manufactured from high grade steel alloy
- Features a Lifetime Warranty and exceeds ANSI Standards

# Wrenches Offset Box / Ratcheting Wrenches

## 75° Offset Box



Stock No.	mm	L (mm)	Order No.	Stock No.	mm	L (mm)	Order No.
BBWDM67	6-7	168	405001	BBWDM1921	19-21	318	405014
BBWDM89	8-9	183	405002	BBWDM1922	19-22	318	405015
BBWDM810	8-10	183	405003	BBWDM2022	20-22	318	405016
BBWDM1011	10-11	198	405004	BBWDM2123	21-23	330	405017
BBWDM1012	10-12	198	405005	BBWDM2224	22-24	330	405018
BBWDM1113	11-13	218	405006	BBWDM2326	23-26	346	405019
BBWDM1213	12-13	218	405007	BBWDM2426	24-26	346	405020
BBWDM1214	12-14	218	405008	BBWDM2427	24-27	346	405021
BBWDM1415	14-15	235	405009	BBWDM2528	25-28	355	405022
BBWDM1417	14-17	260	405010	BBWDM2430	24-30	355	405023
BBWDM1617	16-17	260	405011	BBWDM2730	27-30	355	405055
BBWDM1719	17-19	292	405012	BBWDM3032	30-32	372	405024
BBWDM1819	18-19	292	405013	BBWDM3436A	34-36	440	405056

## 45° Offset Box



Stock No.	mm	L (mm)	Order No.	Stock No.	mm	L (mm)	Order No.
BBWSM67	6-7	165	405025	BBWSM1819	18-19	250	405040
BBWSM89	8-9	175	405026	BBWSM1921	19-21	270	405041
BBWSM810	8-10	185	405027	BBWSM1922	19-22	270	405042
BBWSM911	9-11	195	405028	BBWSM2022	20-22	270	405043
BBWSM1011	10-11	195	405029	BBWSM2122	21-22	290	405044
BBWSM1012	10-12	195	405030	BBWSM2123	21-23	290	405045
BBWSM1113	11-13	205	405031	BBWSM2224	22-24	320	405046
BBWSM1213	12-13	205	405032	BBWSM2326	23-26	360	405047
BBWSM1214	12-14	220	405033	BBWSM2426	24-26	360	405048
BBWSM1314	13-14	220	405034	BBWSM2427	24-27	360	405049
BBWSM1415	14-15	235	405035	BBWSM2528	25-28	370	405050
BBWSM1417	14-17	235	405036	BBWSM2730	27-30	380	405053
BBWSM1516	15-16	240	405037	BBWSM2732	27-32	380	405051
BBWSM1617	16-17	240	405038	BBWSM3032	30-32	380	405052
BBWSM1719	17-19	250	405039	BBWSM3436	34-36	405	405054

## Ratchet Combination

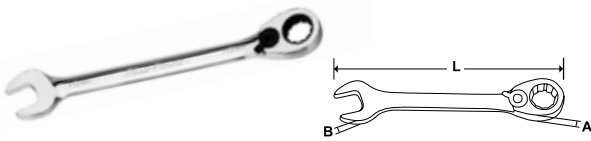

Stock No.	mm	A (mm)	B (mm)	L (mm)	Order No.
BOERM6	6	6.6	3.6	114	406001
BOERM7	7	6.6	3.9	125	406002
BOERM8	8	6.5	4.0	135	406003
BOERM9	9	7.4	4.0	150	406004
BOERM10	10	8.0	5.0	160	406005
BOERM11	11	8.5	5.5	170	406006
BOERM12	12	9.0	5.5	175	406007
BOERM13	13	10.0	6.3	180	406008
BOERM14	14	10.0	6.5	190	406009
BOERM15	15	11.0	7.0	200	406010
BOERM16	16	11.0	7.0	210	406011
BOERM17	17	12.0	7.0	230	406012
BOERM18	18	12.0	8.0	240	406013
BOERM19	19	12.9	8.7	250	406014
BOERM21	21	13.7	9.4	266	406015
BOERM22	22	14.5	9.4	286	406016
BOERM24	24	15.5	11.2	305	406017
BOERM25	25	15.5	11.2	327	406018

- Dual pawl ratcheting box end yields smooth operation and maximum strength
- 15° offset box head provides extra knuckle clearance
- 4.5° (5° on smaller wrenches) gear engagement means less movement to engage the next gear
- Inch scale laser etched on head face
- Ratcheting box is reversible
- Box end features the FLANK DRIVE® wrenching configuration for greater torque with less applied force
- Tough, durable nickel-chrome finish
- Meets or exceeds strength specifications in ASME B107.6

## Ratchet Combination



Stock No.	mm	A (inches)	B (inches)	L (inches)	Order No.
BOER8	1/4	1/4	5/32	4 1/2	406019
BOER10	5/16	1/4	5/32	5 5/16	406020
BOER12	3/8	5/16	3/16	6 5/16	406021
BOER14	7/16	11/32	7/32	6 11/16	406022
BOER16	1/2	13/32	1/4	7 1/16	406023
BOER18	9/16	13/32	1/4	7 1/2	406024
BOER20	5/8	7/16	9/32	8 1/4	406025
BOER22	11/16	15/32	9/32	9 1/16	406026
BOER24	3/4	1/2	11/32	9 13/16	406027
BOER26	13/16	17/32	3/8	10 1/2	406028
BOER28	7/8	9/16	3/8	11 1/4	406029
BOER30	15/16	5/8	7/16	12	406030
BOER32	1	5/8	7/16	12 7/8	406031

- Dual pawl ratcheting box end yields smooth operation and maximum strength
- 15° offset box head provides extra knuckle clearance
- 4.5° (5° on smaller wrenches) gear engagement means less movement to engage the next gear
- Inch scale laser etched on head face
- Ratcheting box is reversible
- Box end features the FLANK DRIVE® wrenching configuration for greater torque with less applied force
- Tough, durable nickel-chrome finish
- Meets or exceeds strength specifications in ASME B107.6



# Wrenches Ratcheting Wrenches

## Short Ratchet Combination



Stock No.	mm	A (mm)	B (mm)	L (mm)	⊞	Order No.
BOERMS8	8	6.5	4.0	90	6	406052
BOERMS9	9	7.4	4.0	95	6	406053
BOERMS10	10	8.0	5.0	100	6	406054
BOERMS11	11	8.5	5.5	105	6	406055
BOERMS12	12	9.0	5.5	110	6	406056
BOERMS13	13	10.0	6.3	115	6	406057
BOERMS14	14	10.0	6.5	120	6	406058
BOERMS15	15	11.0	7.0	125	6	406059
BOERMS16	16	11.0	7.0	128	6	406060
BOERMS17	17	12.0	7.0	132	6	406061
BOERMS18	18	12.0	8.0	138	6	406062
BOERMS19	19	12.9	8.7	142	6	406063

- Dual pawl reversible ratcheting box end
- Low profile easy action reverse lever won't get in your way
- Tough, durable nickel chrome finish
- Up to 80 gear teeth for ratcheting in tight areas

## Short Ratchet Combination



Stock No.	11	A (inches)	B (inches)	L (inches)	⊞	Order No.
BOERS10	5/16	1/4	5/32	3 9/16	6	406064
BOERS12	3/8	5/16	3/16	3 15/16	6	406065
BOERS14	7/16	11/32	7/32	4 1/8	6	406066
BOERS16	1/2	13/32	1/4	4 1/2	6	406067
BOERS18	9/16	13/32	1/4	4 3/4	6	406068
BOERS20	5/8	7/16	9/32	5 1/16	6	406069
BOERS22	11/16	15/32	9/32	5 3/16	6	406070
BOERS24	3/4	1/2	11/32	5 9/16	6	406071

- Dual pawl reversible ratcheting box end
- Low profile easy action reverse lever won't get in your way
- Tough, durable nickel chrome finish
- Up to 80 gear teeth for ratcheting in tight areas

## Flex Head Ratchet Combination



Stock No.	mm	A (mm)	B (mm)	L (mm)	⊞	Order No.
BOERMF8A	8	6.5	4.0	142	6	406032
BOERMF9A	9	7.4	4.0	152	6	406033
BOERMF10A	10	8.0	5.0	162	6	406034
BOERMF11A	11	8.5	5.5	172	6	406035
BOERMF12A	12	9.0	5.5	180	6	406036
BOERMF13A	13	10.0	6.3	188	6	406037
BOERMF14A	14	10.0	6.5	196	6	406038
BOERMF15A	15	11.0	7.0	204	6	406039
BOERMF16A	16	11.0	7.0	214	6	406040
BOERMF17A	17	12.0	7.0	228	6	406041
BOERMF18A	18	12.0	8.0	242	6	406042
BOERMF19A	19	12.9	8.7	256	6	406043

- Flex head pivots 90 degrees in either direction
- Dual pawl reversible ratcheting box end
- Low profile easy action reverse lever won't get in your way
- Tough, durable nickel chrome finish
- Up to 80 gear teeth for ratcheting in tight areas

## Flex Head Ratchet Combination



Stock No.	11	A (inches)	B (inches)	L (inches)	⊞	Order No.
BOERF10A	5/16	1/4	5/32	5 19/32	6	406044
BOERF12A	3/8	5/16	3/16	6 3/8	6	406045
BOERF14A	7/16	11/32	7/32	6 3/4	6	406046
BOERF16A	1/2	13/32	1/4	7 13/32	6	406047
BOERF18A	9/16	13/32	1/4	7 23/32	6	406048
BOERF20A	5/8	7/16	9/32	8 7/16	6	406049
BOERF22A	11/16	15/32	9/32	8 31/32	6	406050
BOERF24A	3/4	1/2	11/32	10 1/16	6	406051

- Flex head pivots 90 degrees in either direction
- Dual pawl reversible ratcheting box end
- Low profile easy action reverse lever won't get in your way
- Tough, durable nickel chrome finish
- Up to 80 gear teeth for ratcheting in tight areas



# Wrenches Ratcheting Wrenches

## Short Flex Head Ratchet Combination

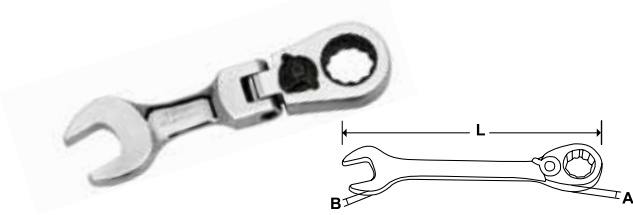

Stock No.	mm	A (mm)	B (mm)	L (mm)		Order No.
BOERMSF8	8	6.5	4.0	94	6	406072
BOERMSF9	9	7.4	4.0	98	6	406073
BOERMSF10	10	8.0	5.0	103	6	406074
BOERMSF11	11	8.5	5.5	108	6	406075
BOERMSF12	12	9.0	5.5	111	6	406076
BOERMSF13	13	10.0	6.3	115	6	406077
BOERMSF14	14	10.0	6.5	120	6	406078
BOERMSF15	15	11.0	7.0	124	6	406079
BOERMSF16	16	11.0	7.0	128	6	406080
BOERMSF17	17	12.0	7.0	133	6	406081
BOERMSF18	18	12.0	8.0	140	6	406082
BOERMSF19	19	12.9	8.7	147	6	406083

- Flex head pivots 90 degrees in either direction
- Dual pawl reversible ratcheting box end
- Up to 80 gear teeth for ratcheting in tight areas

## Short Flex Head Ratchet Combination



Stock No.	mm	A (inches)	B (inches)	L (inches)		Order No.
BOERSF10	5/16	1/4	5/32	3 11/16	6	406084
BOERSF12	3/8	5/16	3/16	4 1/16	6	406085
BOERSF14	7/16	11/32	7/32	4 1/4	6	406086
BOERSF16	1/2	13/32	1/4	4 17/32	6	406087
BOERSF18	9/16	13/32	1/4	4 23/32	6	406088
BOERSF20	5/8	7/16	9/32	5 1/32	6	406089
BOERSF22	11/16	15/32	9/32	5 1/4	6	406090
BOERSF24	3/4	1/2	11/32	5 25/32	6	406091

- Flex head pivots 90 degrees in either direction
- Dual pawl reversible ratcheting box end
- Up to 80 gear teeth for ratcheting in tight areas

## Locking Flex Head Ratchet

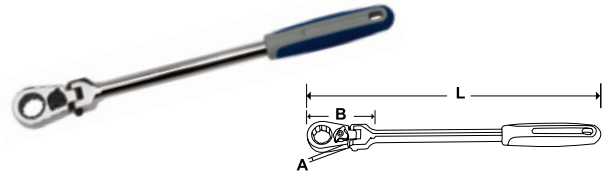

Stock No.	mm	A (mm)	B (mm)	L (mm)		Order No.
BOERMFLCG8	8	6.55	32	228	6	406092
BOERMFLCG9	9	7.45	34	229	6	406093
BOERMFLCG10	10	8.05	38	233	6	406094
BOERMFLCG11	11	8.55	40	235	6	406095
BOERMFLCG12	12	9.05	42	285	6	406096
BOERMFLCG13	13	10.05	45	287	6	406097
BOERMFLCG14	14	10.05	48	289	6	406098
BOERMFLCG15	15	11.05	52	293	6	406099
BOERMFLCG16	16	11.05	54	347	6	406100
BOERMFLCG17	17	12.05	56	348	6	406101
BOERMFLCG18	18	12.05	60	352	6	406102
BOERMFLCG19	19	12.95	64	354	6	406103

## Locking Flex Head Ratchet

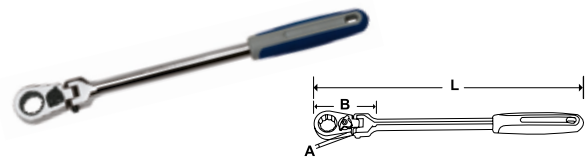

Stock No.	mm	A (inches)	B (inches)	L (inches)		Order No.
BOERFLCG10	5/16	1/4	1 1/4	9	6	406104
BOERFLCG12	3/8	5/16	1 1/2	8 1/4	6	406105
BOERFLCG14	7/16	11/32	1 9/16	9 19/32	6	406106
BOERFLCG16	1/2	13/32	1 25/32	11 9/32	6	406107
BOERFLCG18	9/16	13/32	1 29/32	11 3/8	6	406108
BOERFLCG20	5/8	7/16	2 1/8	13 21/32	6	406109
BOERFLCG22	11/16	15/32	2 7/32	13 23/32	6	406110
BOERFLCG24	3/4	1/2	2 17/32	13 15/16	6	406111

- Corrosive resistant bi-mold cushion grips for improved comfort and performance
- Wrenches have multiple locking head positions for easier access to tough to reach fasteners
- Long reach solid shank steel handle for improved reach and leverage
- Dual pawl reversible ratchet head
- Flex head pivots 90 degrees in either direction

# Wrenches

Ratcheting Wrenches / L and T shape Wrenches / Other Wrenches

## Ratcheting Box

Stock No.	mm	A (mm)	L (mm)		Order No.
RBZM78	7 - 8	15.1 - 17.1	114	1	406112
RBZM910	9 - 10	20.4 - 22.6	140	1	406113
RBZM1112	11 - 12	25.8 - 29.4	175	1	406114
RBZM1314	13 - 14	25.8 - 29.4	175	1	406115
RBZM1517	15 - 17	32.9 - 36.5	206	1	406116
RBZM1618	16 - 18	32.9 - 36.5	206	1	406117
RBZM1921	19 - 21	35.7 - 40.1	235	1	406118

## Ratcheting Box

Stock No.	11	A (inches)	L (inches)		Order No.
RBZ810	1/4 - 5/16	3/8	4 1/2	1	406119
RBZ1214	3/8 - 7/16	3/8	5 7/2	1	406120
RBZ1618	1/2 - 9/16	1/2	6 1/8	1	406121
RBZ2022	5/8 - 11/16	1/2	9 1/4	1	406122
RBZ2428	3/4 - 7/8	1/2	9 1/4	1	406123

## L-Shape Hex Keys

Stock No.	mm	A (mm)	L (mm)		Order No.
BLWM11	11	42	190	6	407031
BLWM12	12	44	209	6	407002
BLWM13	13	50	220	6	407032
BLWM14	14	54.5	233	6	407003
BLWM15	15	56.5	237	6	407033
BLWM16	16	58.5	240	6	407034
BLWM17	17	61.5	246	6	407004
BLWM18	18	64.5	261	6	407035
BLWM19	19	68.5	276	6	407005

- Made from high torque steel
- Heavy duty usage
- Satin finish

## T-Shape Hex Keys

Stock No.	mm	A (mm)	L (mm)		Order No.
BTWM1.5	1.5	83	122	6	407007
BTWM2.5	2.5	83	122	6	407008
BTWM3	3	83	122	6	407009
BTWM4	4	83	122	6	407010
BTWM5	5	83	122	6	407011
BTWM6	6	134	186	6	407012
BTWM7	7	134	186	6	407013
BTWM8	8	134	186	6	407014

- Ergonomical handle for a better grip
- Made from high torque steel

## T-Shape Speeder Wrench

Stock No.	A (mm)	B (mm)	L (mm)		Order No.
BPTHM08	8	200	250	1	407015
BPTHM09	9	200	250	1	407016
BPTHM10	10	200	250	1	407017
BPTHM11	11	200	250	1	407018
BPTHM12	12	250	250	1	407019
BPTHM13	13	250	300	1	407020
BPTHM14	14	250	300	1	407021

- Speedy socket wrench, convenience for use
- Magnetic inset for convenience

## Chain Wrench

Stock No.	Chain Length (inches)	Capacity (inches)	Handle Length (inches)		Order No.
CW12A	16	4	12	6	408001
CW15A	19	5	15	6	408002
CW24A	23	6	24	6	408003

## Strap Wrench

Stock No.	Diameter		Order No.
BLPSTWR4	4" max	1	408005
BLPSTWR6	6" max	1	408006

- Adjusts to fit any circumference or irregular shape
- Grip, loosen or tighten almost anything
- Won't scratch or damage surfaces
- Cushioned grip for maximum comfort
- Heavy duty construction for longer life

• **BLPSTWRKT**(Order No.408004)**Set includes BLPSTWR4 & BLPSTWR6**



# SCREWDRIVERS & BITS

Blue-Point's screwdrivers give you better grip and higher turning force with tool tip durability to match.

Handles using dual compound are ergonomically shaped to fit your palm for comfort and better grip.

The high strength Molybdenum-Vanadium steel shanks are nickel and chrome plated for toughness and corrosion resistance.

Vapor-blasted tips offer greater screw-tip adherence to prevent the rounding of screws and screwdrivers alike.

Finer details like laser-etching of the size and part numbers are not missed. This ensure permanence with continual usage over time.

We even offer three colours in the same range to facilitate tool identification and differentiation for different work-teams.





Screwdrivers

50

Bits

53

# Screwdriver & Bits Screwdrivers

## P Series, Slotted

1 Vapor-blasted tip for greater screw-tip adherence

2 The chrome molybdenum vanadium blade is hardened to HRC 59±1



3 Size and part number are laser-etched on the blade to ensure permanence

4 Nickel and chrome plated to prevent rust



5 Ergonomically shaped dual compound handle provides comfort and a better grip

6

## P Series, Phillips®

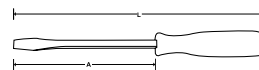

Stock No. (Blue)	Order No.	Stock No. (Yellow)	Order No.	Stock No. (Red)	Order No.	Tip Size	A (mm)	L (mm)
BSGD75PH0B	501001	BSGD75PH0Y	501030	BSGD75PH0R	501059	PH0	75	148
BSGD100PH0B	501002	BSGD100PH0Y	501031	BSGD100PH0R	501060	PH0	100	187
BSGD150PH0B	501003	BSGD150PH0Y	501032	BSGD150PH0R	501061	PH0	150	237
BSGD100PH1B	501004	BSGD100PH1Y	501033	BSGD100PH1R	501062	PH1	100	208
BSGD150PH1B	501005	BSGD150PH1Y	501034	BSGD150PH1R	501063	PH1	150	258
BSGD200PH1B	501006	BSGD200PH1Y	501035	BSGD200PH1R	501064	PH1	200	308
BSGD250PH1B	501007	BSGD250PH1Y	501036	BSGD250PH1R	501065	PH1	250	358
BSGD300PH1B	501008	BSGD300PH1Y	501037	BSGD300PH1R	501066	PH1	300	408
BSGD100PH2B	501009	BSGD100PH2Y	501038	BSGD100PH2R	501067	PH2	100	208
BSGD150PH2B	501010	BSGD150PH2Y	501039	BSGD150PH2R	501068	PH2	150	258
BSGD200PH2B	501011	BSGD200PH2Y	501040	BSGD200PH2R	501069	PH2	200	308
BSGD250PH2B	501012	BSGD250PH2Y	501041	BSGD250PH2R	501070	PH2	250	358
BSGD300PH2B	501013	BSGD300PH2Y	501042	BSGD300PH2R	501071	PH2	300	408
BSGD150PH3B	501014	BSGD150PH3Y	501043	BSGD150PH3R	501072	PH3	150	270
BSGD200PH3B	501015	BSGD200PH3Y	501044	BSGD200PH3R	501073	PH3	200	320

- 2-Component handle gives the screwdriver an ideal ergonomic shape
- Perfectly adapted to the forces exerted by the hand and permits work efficiently
- The chrome molybdenum vanadium blade is hardened to HRC 59±1
- Nickel and chrome plated blade and the tip is especially vapor-blasted for greater screw-tip adherence and a full anti-rust guarantee
- With hanging hole moulded to the blade
- The size and part number are laser-etched on the blade to ensure their permanence

# Screwdriver & Bits Screwdrivers

## P Series, Slotted

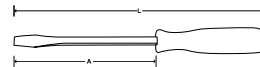

Stock No. (Blue)	Order No.	Stock No. (Yellow)	Order No.	Stock No. (Red)	Order No.	Tip Size	A (mm)	L (mm)
BSGD75S3B	501016	BSGD75S3Y	501045	BSGD75S3R	501074	3mm	75	147
BSGD75F4B	501017	BSGD75F4Y	501046	BSGD75F4R	501075	4mm	100	168
BSGD100S4B	501018	BSGD100S4Y	501047	BSGD100S4R	501076	4mm	125	188
BSGD125S4B	501019	BSGD125S4Y	501048	BSGD125S4R	501077	4mm	150	233
BSGD150S4B	501020	BSGD150S4Y	501049	BSGD150S4R	501078	4mm	250	308
BSGD250S4B	501021	BSGD250S4Y	501050	BSGD250S4R	501079	5.5mm	125	358
BSGD125S5B	501022	BSGD125S5Y	501051	BSGD125S5R	501080	5.5mm	150	208
BSGD150S5B	501023	BSGD150S5Y	501052	BSGD150S5R	501081	6.5mm	250	258
BSGD125F5B	501024	BSGD125F5Y	501053	BSGD125F5R	501082	4mm	75	233
BSGD125F6B	501025	BSGD125F6Y	501054	BSGD125F6R	501083	5.5mm	125	208
BSGD150F6B	501026	BSGD150F6Y	501055	BSGD150F6R	501084	6.5mm	125	258
BSGD250F6B	501027	BSGD250F6Y	501056	BSGD250F6R	501085	6.5mm	150	358
BSGD150F8B	501028	BSGD150F8Y	501057	BSGD150F8R	501086	8mm	150	270
BSGD175F8B	501029	BSGD175F8Y	501058	BSGD175F8R	501087	8mm	175	320

- 2-Component handle gives the screwdriver an ideal ergonomic shape
- Perfectly adapted to the forces exerted by the hand and permits work efficiently
- The chrome molybdenum vanadium blade is hardened to HRC 59±1
- Nickel and chrome plated blade and the tip is especially vapor-blasted for greater screw-tip adherence and a full anti-rust guarantee
- With hanging hole moulded to the blade
- The size and part number are laser-etched on the blade to ensure their permanence

## Ratcheting Screwdriver

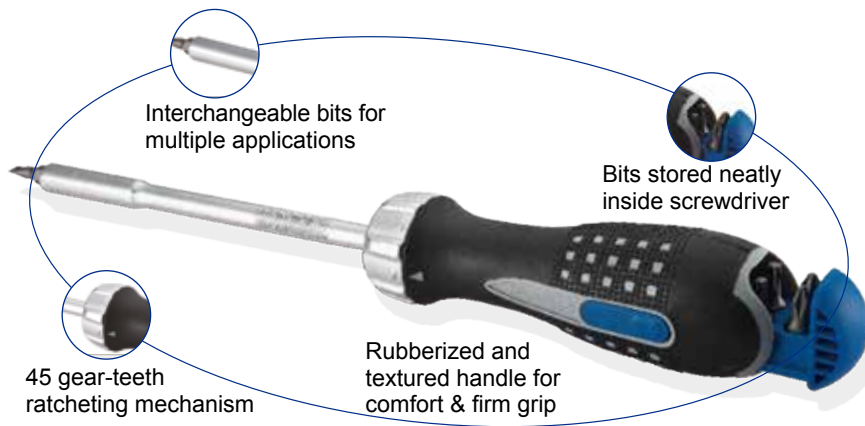

## 1/4" Ratchet Screwdriver, Pistol Handle

Packing: 1

BSGDMR6  
Order NO.: 502001



- 5" magnetic bit holder blade for 1/4" hex bits
- 45 tooth ratcheting mechanism ensures precise positioning and movement
- Bits are stored in a bit magazine inside the handle
- Includes six 1/4" hex bits: Flat Tip (4.5 and 5.5), Phillips® (#1 and #2) plus Torx® (T15 and T20)
- Ergonomically designed two component handle is textured for excellent grip and user comfort
- Provides three functional options, left and right turning and locked position
- Blade features a knurled-grip for fast spinning of the fastener
- Screwdriver carries a lifetime warranty (Bits are consumable and carry no warranty)



# Screwdriver & Bits Screwdrivers

## P Series VDE, Phillips®

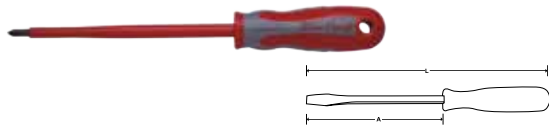

Stock No.	Tip Size	A (mm)	L (mm)		Order No.
BSGDV100PH0	PH0	100	148	10	501088
BSGDV150PH1	PH1	150	188	10	501089
BSGDV175PH2	PH2	175	208	10	501090
BSGDV200PH3	PH3	200	270	10	501091

## P Series VDE, Slotted

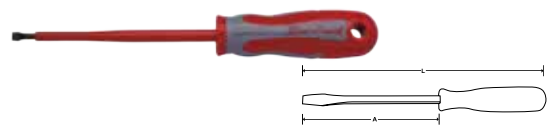

Stock No.	Tip Size	A (mm)	L (mm)		Order No.
BSGDV100S2	2.5mm	100	163	10	501092
BSGDV100S3	3mm	100	188	10	501093
BSGDV100S4	4mm	100	208	10	501094
BSGDV125S5	5.5mm	125	233	10	501095
BSGDV150S6	6.5mm	150	258	10	501096

- Insulated screwdriver for Phillips PH-head screws, for work on live equipment up to 1000V
- Examination of screwdrivers according to latest national and international standards
- Examination piece-wise in water bath with 10 KV
- Ergonomically developed 2-component handle
- Blade black oxidized, entirely hardened



## M Series, Slotted

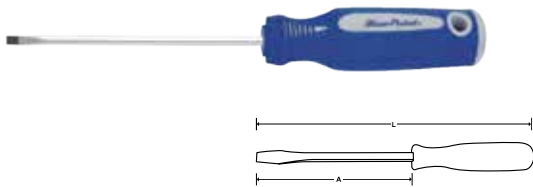

Stock No.	Tip Size (mm)	A (mm)	L (mm)		Order No.	Stock No.	Tip Size (mm)	A (mm)	L (mm)		Order No.
BSGDM65F2	2.4	65	136	6	501097	BSGDM38F6	6	38	100	6	501105
BSGDM75F3	3.2	75	149	6	501098	BSGDM100F6	6	100	220	6	501106
BSGDM100F3	3.2	100	175	6	501099	BSGDM150F6	6	150	270	6	501107
BSGDM150F3	3.2	150	225	6	501100	BSGDM200F6	6	200	321	6	501108
BSGDM75F5	5	75	182	6	501101	BSGDM250F6	6	250	372	6	501109
BSGDM100F5	5	100	208	6	501102	BSGDM150F8	8	150	280	6	501110
BSGDM150F5	5	150	258	6	501103	BSGDM200F8	8	200	331	6	501111
BSGDM200F5	5	200	309	6	501104	BSGDM200F9	9.5	200	331	6	501112

## M Series, Pozidriv®



Stock No.	Tip Size (mm)	A (mm)	L (mm)		Order No.	Stock No.	Tip Size (mm)	A (mm)	L (mm)		Order No.
BSGDM65PZ0	0	65	136	6	501128	BSGDM100PZ2	2	100	218	6	501136
BSGDM75PZ0	0	75	148	6	501129	BSGDM150PZ2	2	150	268	6	501137
BSGDM100PZ0	0	100	173	6	501130	BSGDM200PZ2	2	200	318	6	501138
BSGDM150PZ0	0	150	223	6	501131	BSGDM250PZ2	2	250	368	6	501139
BSGDM75PZ1	1	75	181	6	501132	BSGDM150PZ3	3	150	278	6	501140
BSGDM100PZ1	1	100	206	6	501133	BSGDM200PZ3	3	200	328	6	501141
BSGDM150PZ1	1	150	256	6	501134	BSGDM200PZ4	4	200	328	6	501142
BSGDM38PZ2	2	38	100	6	501135						

- Tri-lobe handle shape for reducing user strain while operating and offering optimum torque
- Soft cushion grip for the best performance without fatigue
- Concave hollow of the handle neck for firm pinch pressure and precision control



# Screwdriver & Bits

Screwdrivers / Bits

## M Series, Phillips®



Stock No.	Tip Size (mm)	A (mm)	L (mm)	Order No.	Stock No.	Tip Size (mm)	A (mm)	L (mm)	Order No.
BSGDM65PH00	00	65	136	6 501113	BSGDM100PH2	2	100	218	6 501121
BSGDM75PH0	0	75	148	6 501114	BSGDM150PH2	2	150	268	6 501122
BSGDM100PH0	0	100	173	6 501115	BSGDM200PH2	2	200	318	6 501123
BSGDM150PH0	0	150	223	6 501116	BSGDM250PH2	2	250	368	6 501124
BSGDM75PH1	1	75	181	6 501117	BSGDM150PH3	3	150	278	6 501125
BSGDM100PH1	1	100	206	6 501118	BSGDM200PH3	3	200	328	6 501126
BSGDM150PH1	1	150	256	6 501119	BSGDM200PH4	4	200	328	6 501127
BSGDM38PH2	2	38	100	6 501120					

## M Series, Torx®



Stock No.	Tip Size (mm)	A (mm)	L (mm)	Order No.	Stock No.	Tip Size (mm)	A (mm)	L (mm)	Order No.
BSGDM75TX6	T6	75	148	6 501143	BSGDM100TX20	T20	100	206	6 501149
BSGDM75TX7	T7	75	148	6 501144	BSGDM100TX25	T25	100	218	6 501150
BSGDM75TX8	T8	75	148	6 501145	BSGDM100TX27	T27	100	218	6 501151
BSGDM75TX9	T9	75	148	6 501146	BSGDM100TX30	T30	100	218	6 501152
BSGDM100TX10	T10	100	206	6 501147	BSGDM100TX40	T40	100	218	6 501153
BSGDM100TX15	T15	100	206	6 501148					

- Tri-lobe handle shape for reducing user strain while operating and offering optimum torque
- Soft cushion grip for the best performance without fatigue
- Concave hollow of the handle neck for firm pinch pressure and precision control

## Bits



Hex Bit
  Tamper Resistant Torx Bit
  Flat Tip Bit
  Phillips Tip Bit
  Square Tip Bit

Stock No.	Description	Size	Order No.
BLPFB532	Flat Tip Bit	5/32"	502002
BLPFB732	Flat Tip Bit	7/32"	502003
BLPFB932	Flat Tip Bit	9/32"	502004
BLPFB316	Flat Tip Bit	3/16"	502005
BLPFB14	Flat Tip Bit	1/4"	502006
BLPPB0	Phillips Tip Bit	#0	502007
BLPPB1	Phillips Tip Bit	#1	502008
BLPPB2	Phillips Tip Bit	#2	502009
BLPPB3	Phillips Tip Bit	#3	502010
BLPHBM3	Hex Bit	3mm	502011
BLPHBM4	Hex Bit	4mm	502012
BLPHBM5	Hex Bit	5mm	502013
BLPHBM6	Hex Bit	6mm	502014
BLPHB18	Hex Bit	1/8"	502015
BLPHB964	Hex Bit	9/64"	502016
BLPHB532	Hex Bit	5/32"	502017
BLPHB316	Hex Bit	3/16"	502018
BLPHB732	Hex Bit	7/32"	502019
BLPHB14	Hex Bit	1/4"	502020
BLPTB10TP	Tamper Resistant Torx Bit	T10	502021
BLPTB15TP	Tamper Resistant Torx Bit	T15	502022
BLPTB20TP	Tamper Resistant Torx Bit	T20	502023
BLPTB25TP	Tamper Resistant Torx Bit	T25	502024
BLPTB30TP	Tamper Resistant Torx Bit	T30	502025
BLPSQB1	Square Tip Bit	#1	502026
BLPSQB2	Square Tip Bit	#2	502027



# Pliers

At Blue-Point, we created a broad range of high performance pliers for most applications today while keeping at a very affordable price.

Like our screwdrivers, we also adopt a dual compound design for the handle to improve gripping comfort and reduce hand fatigue.

The joints are precision machined and located for high leverage thus requiring less effort for every crimping and cutting task.

We even use laser hardening on the cutting edges of our pliers!

Blue-Point pliers are where good quality comes at a good price. And our broad range completes your search for the right tool to the job.





Pliers  
Sets

56

Standard  
Pliers

58

VDE  
Pliers

67

Locking  
Pliers

68

Retaining  
Ring Pliers

69

Special  
Pliers

69

# Pliers Pliers Sets

## Pliers Set, Dipped Grips, 8pcs

Packing: 8

BDGPL800  
Order NO.: 601007



Stock No.	Description	Jaw Capacity (inches)	Length (inches)		Order No.
BDGAWP100Z	Adjustable Joint Pliers	1 3/4	10	6	602001
BDG48CPZ	Slip Joint Pliers	1 27/32	8	6	602037
BDG98CPZ	Needle Nose Pliers	3	8	6	602004
BDG9845CPZ	45° Bent Needle Nose Pliers	2 13/16	7 3/4	6	602010
BDG57CPZ	Lineman's Pliers	1 1/4	7 1/2	6	602006
BDGEC7Z	End Cutter	7/16	7	6	602009
BDG86CPZ	Diagonal Cutter	2 1/32	6 1/2	6	602005
BDG88CPZ	Diagonal Cutter	1 5/16	8 1/8	6	602008

- Includes BDGAWP100Z adjustable joint pliers, BDG48CPZ slip joint pliers, BDG98CPZ and BDG9845CPZ needle nose pliers, BDG57CPZ Lineman's pliers, BDG86CPZ and BDG88CPZ diagonal cutters plus BDGEC7Z end cutters (8 pcs) in storage tray

## Mini Pliers Set, 10pcs

Packing: 10

BMPL1000  
Order NO.: 601009



Stock No.	Description	Jaw Capacity (inches)	Length (inches)		Order No.
B45CMPAP	Combination Pliers	1	4 11/16	6	602011
B65CMPAP	Duck Bill Pliers	1 5/32	4 7/8	6	602014
B75CMPAP	Round Nose Pliers	1 5/32	5	6	602017
B85CMPAP	Diagonal Cutter	2 1/32	4 11/32	6	602015
B85CTMPAP	Thin Diagonal Cutter	2 3/32	4 5/8	6	602020
B945CMPAP	45° Bent Nose Pliers	1	4 11/16	6	602013
B95CMPAP	Long Nose Pliers	1 1/8	4 7/8	6	602012
B95CLMPAP	Needle Nose Pliers	2 1/16	5 25/32	6	602019
B960CMPAP	60° Bent Nose Pliers	1 5/16	4 11/16	6	602018
BMPEC5AP	End Cutter	5/16	4 1/32	6	602016

- B45CMPAP, B65CMPAP, B75CMPAP, B85CMPAP, B85CTMPAP, B945CMPAP, B95CLMPAP, B95CMPAP, B960CMPAP and BMPEC5AP (10 pcs.) in storage tray

## Pliers Set, Standard, 5pcs

Packing: 5

BPL501  
Order NO.: 601008



Stock No.	Description	Jaw Capacity (inches)	Length (inches)		Order No.
B48CPAP	Slip Joint Pliers	2 3/32	8 13/32	6	602036
B58HLPAP	Lineman's Pliers	1 1/2	8 31/32	6	602007
B96CPAP	Long Nose Pliers	2 1/32	6 5/16	6	602003
BAWP100AP	Adjustable Joint Pliers	1 3/8	10 5/32	6	602038
B87CPAP	Diagonal Cutters	3 1/32	6 19/32	6	602002

- B48CPAP, B58HLPAP, B87CPAP, B96CPAP and BAWP100AP (5 pcs.) in storage tray

## Mini Pliers Set, 8pcs

Packing: 8

BDGMPL845  
Order NO.: 601015



Stock No.	Description	Jaw Capacity (inches)	Length (inches)		Order No.
BDG45CMP	Mini Combination Pliers	1"	4.5"	6	602074
BDG85CMP	Mini Diagonal Nose Pliers	2 1/32"	4.5"	6	602075
BDG85CTMP	Mini Thin Diagonal Nose Pliers	2 3/32"	4.5"	6	602076
BDG945CMP	Mini 45 Deg Bent Nose Pliers	1"	4.5"	6	602077
BDG65CMP	Mini Flat Nose Pliers	1 5/32"	4.5"	6	602078
BDG95CMP	Mini Long Nose Pliers	4 7/8"	4.5"	6	602079
BDG95CLMP	Mini Needle Nose Pliers	2 1/16"	6"	6	602080
BDGMPEC5	Mini End Cutters	4 1/32"	4.5"	6	602081

- Comes in a compact pouch that is easy to store and carry around
- Pouch design allows for flexibility in storage of different pliers
- Commonly used pliers are included
- Dipped grips deliver optimal comfort during high strength gripping
- Drop forged chrome vanadium steel and fine polished

# Pliers Pliers Sets

## Plier Sets, Standard, 7pcs

Packing: 7

BDGCPL700  
Order NO.: 601016



Stock No.	Description	Jaw Capacity (inches)	Length (inches)		Order No.
BDG98CPZ	Needle Nose Pliers	3"	8"	6	602072
BDG88CPZ	Diagonal Cutters	1 <sup>5</sup> / <sub>16</sub> "	8"	6	602073
BDG45CMP	Mini Combination Pliers	1"	4.5"	6	602074
BDG95CLMP	Mini Long Needle Nose Pliers	2 1 <sup>1</sup> / <sub>16</sub> "	6"	6	602080
BDG85CTMP	Mini Thin Diagonal Nose Pliers	2 <sup>3</sup> / <sub>32</sub> "	4.5"	6	602076
BDG945CMP	Mini 45 Deg Bent Nose Pliers	1"	4.5"	6	602077
BDG48CPZ	Slip Joint Pliers	1 2 <sup>7</sup> / <sub>32</sub> "	8"	6	602071

- Comes in a compact pouch that is easy to store and carry around
- Pouch design allows for flexibility in storage of different pliers
- Commonly used pliers are included
- Dipped grips deliver optimal comfort during high strength gripping
- Drop forged chrome vanadium steel and fine polished

## Long Reach Miniature Pliers Set, 4pcs

Packing: 4

BDGPL400LMP  
Order NO.: 601010



Stock No.	Description	Jaw Capacity (inches)	Length (inches)		Order No.
BDG96LMPZ	Long Nose Pliers	1 5 <sup>1</sup> / <sub>16</sub> "	6	6	602021
BDG97LMPZ	Needle Nose Pliers	2 1 <sup>3</sup> / <sub>32</sub> "	7	6	602022
BDG9645LMPZ	45° Bent Nose Pliers	1 7 <sup>1</sup> / <sub>32</sub> "	6	6	602023
BDG86LMPZ	Diagonal Cutting Pliers	3 <sup>3</sup> / <sub>4</sub> "	5 1 <sup>1</sup> / <sub>2</sub> "	6	602024

- Set includes BDG86LMPZ cutters plus BDG96LMPZ, BDG9645LMPZ and BDG97LMPZ pliers (4 pcs)
- Chrome nickel finish prevents against rust and corrosion
- Cushioned grips offer comfort during extended use
- Vinyl grips provide easy cleanup and durability
- Pliers exceed ANSI standards

## Extended Reach Hose Grip Pliers Set, 3pcs

Packing: 3

BDGPL300HG  
Order NO.: 601012



Stock No.	Description	Jaw Capacity (inches)	Length (inches)		Order No.
BDGPL410HGZ	Small Hose Grip Pliers	2 1 <sup>1</sup> / <sub>4</sub> "	11	6	602030
BDGPL411HGZ	Medium Hose Grip Pliers	2 1 <sup>1</sup> / <sub>4</sub> "	11	6	602031
BDGPL412HGZ	Large Hose Grip Pliers	2	11	6	602032

- Grips are double dipped offering increased comfort and control during use
- Pliers extra length provides additional access to otherwise difficult to reach areas
- Corrosion resistant finish
- Leaf springs improve maneuverability

## Long Reach Pliers Set, 3pcs

Packing: 3

BDGPL300LR  
Order NO.: 601013



Stock No.	Description	Jaw Capacity (inches)	Length (inches)		Order No.
BDG311CPZ	Diagonal Cutter	1 9 <sup>1</sup> / <sub>16</sub> "	11	6	602025
BDG91145CPZ	45° Bent Needle Nose Pliers	3 3 <sup>1</sup> / <sub>16</sub> "	11	6	602026
BDG911CPZ	Needle Nose Pliers	3 3 <sup>1</sup> / <sub>16</sub> "	11	6	602027

- BDG911CPZ and BDG91145CPZ pliers plus BDG311CPZ cutter (3 pcs) in storage tray

## Extra Long Reach Pliers Set, 2pcs

Packing: 2

BDGPL200XLR  
Order NO.: 601014



Stock No.	Description	Jaw Capacity (inches)	Length (inches)		Order No.
BDG91645CPZ	45° Bent Needle Nose Pliers	3 3 <sup>1</sup> / <sub>16</sub> "	16	6	602028
BDG916CPZ	Needle Nose Pliers	3 3 <sup>1</sup> / <sub>16</sub> "	16	6	602029

- BDG916CPZ and BDG91645CPZ (2 pcs) in storage tray

# Pliers Pliers Sets / Standard Pliers

## Retaining Ring Pliers Set, 2pcs

Packing: 1

PR36

Order NO.: 601001



Stock No.	Length (inches)	Ring Size Range (inches)	Tip Kit Included	
PR37	6 1/4	Internal 3/8 - 2	PR5 (For PR36 only)	1
PR38	6 1/4	External 1/4 - 2	—	1
		Tip Sizes Included Inches/Degree	Optional Kits	Optional Tip Sizes
PR37		2 pair each in PR36 set: .047" 0°, .070" 0°, .047" 45°, .039" 90°	PR5	.047" 0°, .070" 0°, .047" 45°, .039" 90°
PR38		—	PR5	.047" 0°, .070" 0°, .047" 45°, .039" 90°

- Includes PR37 and PR38 pliers plus tips

## Retaining Ring Pliers Set, 2pcs

Packing: 1

PR50A

Order NO.: 601004



Stock No.	Length (inches)	Ring Size Range (inches)	Tip Kit Included		Order No.
PR51	9 1/2	2 7/16 - 4	PR502	1	605006
PR52	9 1/2	1 1/2 - 3 11/32	PR507	1	605007
		Tip Sizes Included Inches/Degree	Optional Kits	Optional Tip Sizes	
PR51		.108", 15°	PR501		.108", 0°
PR52		.120", 45°	PR505		.120", 0°

- Includes PR51 and PR52 pliers plus tips in a plastic case

## Retaining Ring Pliers Set, 3pcs

Packing: 1

PRH503

Order NO.: 601003



Stock No.	Length (inches)	Ring Size Range (inches)		Order No.	Tip Kit Included	Tip Sizes Included/ Degree
PRH56A (Convertible)	6 3/8	Internal 1/4 - 1 External 1/8 - 1	6	605003	PRH56A-1	1 pair each: .023" 0°, .036" 0°, .047 0°, .036" 90°, .047" 90°
PRH57A (Convertible)	8	Internal 3/8 - 2 External 1/4 - 2	6	605004	PRH57A-1	1 pair each: .036" 0°, .047" 0°, .070 0°, .036" 90°, .047 90°
PRC65A (Convertible)	10	Internal 1 13/64 - 4 External 1 1/8 - 4	6	605005	PRC65A-1	1 pair each: .090", .108", .120" (15° and 90°)

- Includes PRH56A, PRH57A and PRC65A retaining ring pliers
- PRH502A (Order No. 601002) set includes PRH56A and PRH57A retaining ring pliers
- Pliers in storage case

## Diagonal Cutter



Stock No.	Description	Jaw Capacity (inches)	Length (inches)		Order No.
BDG86CPZ	Diagonal Cutter	2 1/32	6 1/2	6	602005
BDG88CPZ	Diagonal Cutter	1 9/16	8 1/8	6	602008
BDGCT6K	Diagonal Cutting Pliers, Dipped Grip	7/16	6	6	602048

- Dipped grip handles for easy cleaning
- Drop forged chrome/nickel alloy is fine polished for corrosion resistant finish
- Laser hardened cutting edge

# Pliers Standard Pliers

## Combination Pliers



Stock No.	Description	Jaw Capacity (inches)	Length (inches)		Order No.
BDG57CPZ	Combination Pliers	1 1/4	7 1/2	6	602006
BDGCB8K	Combination Pliers, Dipped Grip	7/8	8	6	602050
BDGCB9HK	Combination Pliers, Dipped Grip, High Leverage	7/8	9	6	602051

- Dipped grip handles for easy cleaning
- Drop forged chrome/nickel alloy is fine polished for corrosion resistant finish
- Laser hardened cutting edge

## Slip Joint Pliers, Dipped Grip

Packing: 6



Stock No.	Description	Jaw Capacity (inches)	Length (inches)
BDG48CPZ	Slip Joint Pliers	1 27/32	8

- Dipped grip handles for easy cleaning
- Drop forged chrome/nickel alloy is fine polished for corrosion resistant finish

## End Cutter

Packing: 6

BDGEC7Z  
Order NO.: 602009



Stock No.	Description	Jaw Length (inches)	Length (inches)
BDGEC7Z	End Cutter	7/16	7

- Dipped grip handles for easy cleaning
- Drop forged chrome/nickel alloy is fine polished for corrosion resistant finish



## Adjustable Joint Pliers, Dipped Grip

Packing: 6

BDGAWP100Z  
Order NO.: 602001



Stock No.	Description	Jaw Capacity (inches)	Length (inches)
BDGAWP100Z	Adjustable Joint Pliers	1 3/4	10

- Dipped grip handles for easy cleaning
- Drop forged chrome/nickel alloy is fine polished for corrosion resistant finish

# Pliers Standard Pliers

## Needle Nose Pliers

Packing: 6

BDG98CPZ  
Order NO.: 602004



Stock No.	Description	Jaw Capacity (inches)	Length (inches)
BDG98CPZ	Needle Nose Pliers	3	8

- Dipped grip handles for easy cleaning
- Drop forged chrome/nickel alloy is fine polished for corrosion resistant finish
- Laser hardened cutting edge

## 45° Bent Needle Nose Pliers

Packing: 6

BDG9845CPZ  
Order NO.: 602010



Stock No.	Description	Jaw Capacity (inches)	Length (inches)
BDG9845CPZ	45° Bent Needle Nose Pliers	2 <sup>13</sup> / <sub>16</sub>	7 <sup>3</sup> / <sub>4</sub>

- Dipped grip handles for easy cleaning
- Drop forged chrome/nickel alloy is fine polished for corrosion resistant finish
- Laser hardened cutting edge

## Long Nose Pliers, Dipped Grip

Packing: 6

BDGLN6K  
Order NO.: 602049



Stock No.	Description	Jaw Capacity (inches)	Length (inches)
BDGLN6K	Long Nose Pliers, Dipped Grip	1	6

- Dipped grip handles for easy cleaning
- Drop forged chrome/nickel alloy is fine polished for corrosion resistant finish
- Laser hardened cutting edge

## Circlip Pliers, Straight



Stock No.	Description	Size Range (mm)	Length (inches)	Packing	Order No.
BCES7	External Circlip Pliers, Straight	19-60	7	6	605012
BCES9	External Circlip Pliers, Straight	40-100	9	6	605013
BCIS7	Internal Circlip Pliers, Straight	19-60	7	6	605016
BCIS9	Internal Circlip Pliers, Straight	40-100	9	6	605017

## Circlip Pliers, Bent



Stock No.	Description	Size Range (mm)	Length (inches)	Packing	Order No.
BCER7	External Circlip Pliers, 90 degrees	19-60	7	6	605014
BCER9	External Circlip Pliers, 90 degrees	40-100	9	6	605015
BCIR7	Internal Circlip Pliers, 90 degrees	19-60	7	6	605018
BCIR9	Internal Circlip Pliers, 90 degrees	40-100	9	6	605019

## Screw Removal Pliers

Packing: 6

NEW

BSP6  
Order NO.: 602065



- Jaws shaped specially for removing screws
- Optimal 6" Length



# Pliers Standard Pliers

## Cable Cutter



Stock No.	Description	Length (inches)		Order No.
BCC6HD	Cable Cutter, 6"	6	6	602062
BCC8HD	Cable Cutter, 8"	8	6	602063
BCC10HD	Cable Cutter, 10"	10	6	602064

- Special flip over handle design allows tool to be used for slicing cable sleeve
- Drop forged chrome/nickel alloy is fine polished for corrosion resistant finish
- Precise machined joint for ease of use and longer life
- For cutting cables only

## Cable Diagonal Cutter



Packing: 6



BDGCT6W  
Order NO.: 602067

- Diagonal cutter with holes for stripping cable
- Laser hardened cutting edge

## Plastic Cutter



Packing: 6



BPC6  
Order NO.: 602066

- Flushed cutting edge for perfect cuts
- Thin cutting edge for precise trimming
- Laser hardened cutting edge

## High Leverage Combination Pliers



Stock No.	Description	Length (inches)		Order No.
BCB6HD	High Leverage Combination Pliers	160	6	602053
BCB7HD	High Leverage Combination Pliers	180	6	602054
BCB9HD	High Leverage Combination Pliers	240	6	602055

- New high leverage design delivers superior crimping and cutting force
- Laser hardened cutting edge
- Dual compound soft grip handles provide good grip and comfort
- Drop forged chrome/nickel alloy is fine polished for corrosion resistant finish
- Precise machined joint for ease of use and longer life

## High Leverage Long Nose Pliers



Stock No.	Description	Length (inches)		Order No.
BLN6HD	High Leverage Long Nose Pliers	160	6	602059
BLN7HD	High Leverage Long Nose Pliers	180	6	602060
BLN8HD	High Leverage Long Nose Pliers	200	6	602061

- New high leverage design delivers superior crimping and cutting force
- Laser hardened cutting edge
- Dual compound soft grip handles provide good grip and comfort
- Drop forged chrome/nickel alloy is fine polished for corrosion resistant finish
- Precise machined joint for ease of use and longer life



## High Leverage Diagonal Pliers



Stock No.	Description	Length (inches)		Order No.
BCT6HD	High Leverage Diagonal Cutting Pliers	160	6	602056
BCT7HD	High Leverage Diagonal Cutting Pliers	180	6	602057
BCT8HD	High Leverage Diagonal Cutting Pliers	200	6	602058

- New high leverage design delivers superior crimping and cutting force
- Laser hardened cutting edge
- Dual compound soft grip handles provide good grip and comfort
- Drop forged chrome/nickel alloy is fine polished for corrosion resistant finish
- Precise machined joint for ease of use and longer life

# Pliers Standard Pliers

## Diagonal Cutter



Stock No.	Description	Jaw Capacity (inches)	Length (inches)	Packing	Order No.
B87CPAP	Side Cutter	3 <sup>1</sup> / <sub>32</sub>	6 1 <sup>9</sup> / <sub>32</sub>	6	602002
BDMCT5	Diagonal Cutting Pliers	5 <sup>1</sup> / <sub>16</sub>	5	6	602045
BDMCT6	Diagonal Cutting Pliers	7 <sup>1</sup> / <sub>16</sub>	6	6	602046
BDMCT7	Diagonal Cutting Pliers	1 <sup>1</sup> / <sub>2</sub>	7	6	602047

- Dual compound soft grip handles provide good grip and comfort
- Drop forged chrome/nickel alloy is fine polished for corrosion resistant finish
- Laser hardened cutting edge

## Combination Pliers



Stock No.	Description	Jaw Capacity (inches)	Length (inches)	Packing	Order No.
B58HLPAP	Combination Pliers	1 1/2	8 31/32	6	602007
BDMCB6	Combination Pliers	5/8	6	6	602039
BDMCB7	Combination Pliers	5/8	7	6	602040
BDMCB8	Combination Pliers	7/8	8	6	602041

- Dual compound soft grip handles provide good grip and comfort
- Drop forged chrome/nickel alloy is fine polished for corrosion resistant finish
- Laser hardened cutting edge

## Slip Joint Pliers

Packing: 6

B48CPAP  
Order NO.: 602036



Stock No.	Description	Jaw Capacity (inches)	Length (inches)
B48CPAP	Slip Joint Plier	2 3/32	8 13/32

- Dual compound soft grip handles provide good grip and comfort
- Drop forged chrome/nickel alloy is fine polished for corrosion resistant finish

## Combination Pliers

Tougher steel for cutting harder and thicker wire, laser sharpened & treated cutting edge for less cutting effort

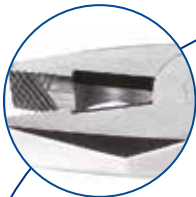

High leverage grip for tubular gripping applications

Dual compound soft grip handles provide good grip and comfort

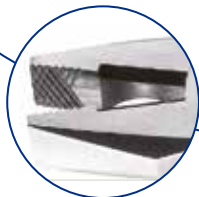
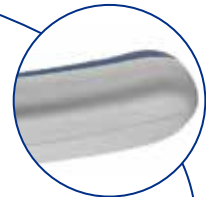

Differential jaws for more secure grip



Precise machined joint for ease of use and longer life

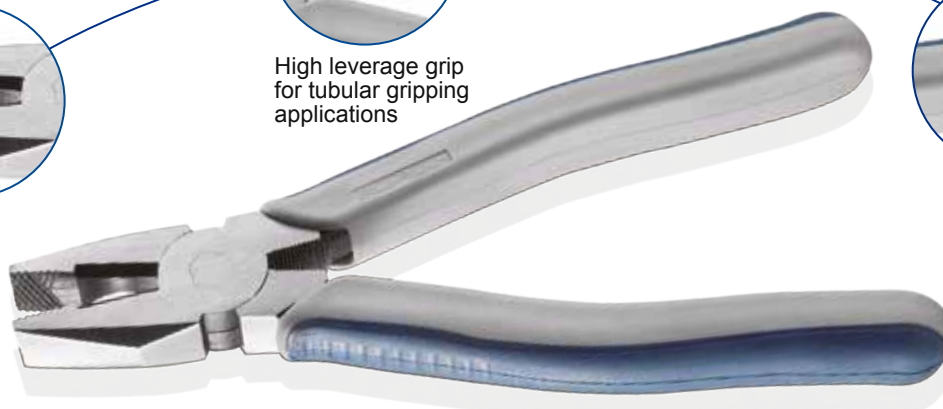

# Pliers Standard Pliers

## Long Nose Pliers



Stock No.	Description	Jaw Capacity (inches)	Length (inches)	Packing	Order No.
B96CPAP	Long Nose Pliers	2 1/32	6 5/16	6	602003
BDMLN6	Long Nose Pliers	1	6	6	602042
BDMLN8	Long Nose Pliers	1 1/8	8	6	602043

- Dual compound soft grip handles provide good grip and comfort
- Drop forged chrome/nickel alloy is fine polished for corrosion resistant finish
- Laser hardened cutting edge

## Adjustable Joint Pliers

Packing: 6



**BDMAJ10**  
Order NO.: 602044

Stock No.	Description	Jaw Capacity (inches)	Length (inches)
BDMAJ10	Adjustable Joint Pliers	1 11/16	10

- Dual compound soft grip handles provide good grip and comfort
- Drop forged chrome/nickel alloy is fine polished for corrosion resistant finish

## Adjustable Joint Pliers

Packing: 6



**BAWP100AP**  
Order NO.: 602038

Stock No.	Description	Jaw Capacity (inches)	Length (inches)
BAWP100AP	Adjustable Joint Pliers	1 3/8	10 5/32

- Dual compound soft grip handles provide good grip and comfort
- Drop forged chrome/nickel alloy is fine polished for corrosion resistant finish

## Mini Round Nose Pliers

Packing: 6



**B75CMPAP**  
Order NO.: 602017

Stock No.	Description	Jaw Capacity (inches)	Length (inches)
B75CMPAP	Mini Round Nose Pliers	1 5/32	5

- Dual compound soft grip handles provide good grip and comfort
- Drop forged chrome/nickel alloy is fine polished for corrosion resistant finish

## Mini Cutter

Packing: 6



**B85CMPAP**  
Order NO.: 602015

Stock No.	Description	Jaw Capacity (inches)	Length (inches)
B85CMPAP	Mini Cutter	2 1/32	4 11/32

- Dual compound soft grip handles provide good grip and comfort
- Drop forged chrome/nickel alloy is fine polished for corrosion resistant finish
- Laser hardened cutting edge

## Mini Thin Diagonal Cutter

Packing: 6



**B85CTMPAP**  
Order NO.: 602020

Stock No.	Description	Jaw Capacity (inches)	Length (inches)
B85CTMPAP	Mini Thin Diagonal Cutter	2 3/32	4 5/8

- Dual compound soft grip handles provide good grip and comfort
- Drop forged chrome/nickel alloy is fine polished for corrosion resistant finish



# Pliers Standard Pliers

## Mini Combination Pliers

Packing: 6

B45CMPAP  
Order NO.: 602011



Stock No.	Description	Jaw Capacity (inches)	Length (inches)
B45CMPAP	Mini Combination Pliers	1	4 11/16

- Dual compound soft grip handles provide good grip and comfort
- Drop forged chrome/nickel alloy is fine polished for corrosion resistant finish
- Laser hardened cutting edge

## Mini Curved Long Nose Pliers

Packing: 6

B945CMPAP  
Order NO.: 602013



Stock No.	Description	Jaw Capacity (inches)	Length (inches)
B945CMPAP	Mini Curved Long Nose Pliers	1	4 11/16

- Dual compound soft grip handles provide good grip and comfort
- Drop forged chrome/nickel alloy is fine polished for corrosion resistant finish

## Mini Long Nose Pliers

Packing: 6

B95CMPAP  
Order NO.: 602012



Stock No.	Description	Jaw Capacity (inches)	Length (inches)
B95CMPAP	Mini Long Nose Pliers	1 1/8	4 7/8

- Dual compound soft grip handles provide good grip and comfort
- Drop forged chrome/nickel alloy is fine polished for corrosion resistant finish
- Laser hardened cutting edge

## Mini 60° Bent Nose Pliers

Packing: 6

B960CMPAP  
Order NO.: 602018



Stock No.	Description	Jaw Capacity (inches)	Length (inches)
B960CMPAP	Mini 60° Bent Nose Pliers	15/16	4 11/16

- Dual compound soft grip handles provide good grip and comfort
- Drop forged chrome/nickel alloy is fine polished for corrosion resistant finish

## Mini Pincer

Packing: 6

BMPEC5AP  
Order NO.: 602016



Stock No.	Description	Jaw Capacity (inches)	Length (inches)
BMPEC5AP	Mini Pincer	5/16	4 1/32

- Dual compound soft grip handles provide good grip and comfort
- Drop forged chrome/nickel alloy is fine polished for corrosion resistant finish

## Mini Needle Nose Pliers

Packing: 6

B95CLMPAP  
Order NO.: 602019



Stock No.	Description	Jaw Capacity (inches)	Length (inches)
B95CLMPAP	Mini Needle Nose Pliers	2 1/16	5 25/32

- Dual compound soft grip handles provide good grip and comfort
- Drop forged chrome/nickel alloy is fine polished for corrosion resistant finish

# Pliers Standard Pliers

## Mini Duck Bill Pliers

Packing: 6

B65CMPAP  
Order NO.: 602014



Stock No.	Description	Jaw Capacity (inches)	Length (inches)
B65CMPAP	Mini Duck Bill Pliers	1 5/32	4 7/8

- Dual compound soft grip handles provide good grip and comfort
- Drop forged chrome/nickel alloy is fine polished for corrosion resistant finish

## Mini Circlip Pliers, Straight



Stock No.	Description	Length (inches)		Order No.
BCES5	External	5	6	605020
BCES6	External	6	6	605021

- Dual compound soft grip handles provide good grip and comfort
- Drop forged chrome/nickel alloy is fine polished for corrosion resistant finish
- Precise machined joint for ease of use and longer life

## Mini Circlip Pliers, Straight



Stock No.	Description	Length (inches)		Order No.
BCIS5	Internal	5	6	605022
BCIS6	Internal	6	6	605023

- Dual compound soft grip handles provide good grip and comfort
- Drop forged chrome/nickel alloy is fine polished for corrosion resistant finish
- Precise machined joint for ease of use and longer life

## Mini Circlip Pliers, 45 Degree



Stock No.	Description	Length (inches)		Order No.
BCEH5	External	5	6	605024
BCEH6	External	6	6	605025

- Dual compound soft grip handles provide good grip and comfort
- Drop forged chrome/nickel alloy is fine polished for corrosion resistant finish
- Precise machined joint for ease of use and longer life

## Mini Circlip Pliers, 45 Degree



Stock No.	Description	Length (inches)		Order No.
BCIH5	Internal	5	6	605026
BCIH6	Internal	6	6	605027

- Dual compound soft grip handles provide good grip and comfort
- Drop forged chrome/nickel alloy is fine polished for corrosion resistant finish
- Precise machined joint for ease of use and longer life



# Pliers Standard Pliers

## Mini Circlip Pliers, 90 Degree



Stock No.	Description	Length (inches)		Order No.
BCER5	External	5	6	605028
BCER6	External	6	6	605029

- Dual compound soft grip provides comfort and control
- Drop forged chrome/nickel alloy is fine polished for corrosion resistant finish
- Precise machined joint for ease of use and longer life

## Mini Circlip Pliers, 90 Degree



Stock No.	Description	Length (inches)		Order No.
BCIR5	Internal	5	6	605030
BCIR6	Internal	6	6	605031

- Dual compound soft grip provides comfort and control
- Drop forged chrome/nickel alloy is fine polished for corrosion resistant finish
- Precise machined joint for ease of use and longer life



## Diagonal Cutting Pliers

1



Drop forged chrome/nickel alloy is fine polished for corrosion resistant finish

3



Soft grip handles provide comfort and control

2



Tougher steel for cutting harder and thicker wire, laser sharpened & treated cutting edge for less cutting effort



# Pliers VDE Pliers

## Long Nose Pliers



Stock No.	Description	Length (mm)	📦	Order No.
WT1001-6	Long Nose Pliers	160	6	603005
WT1001-8	Long Nose Pliers	200	6	603006

- Chrome vanadium steel
- All tools are tested under 10,000 Voltage testing machine
- Special designed soft grips
- Laser hardened cutting edge

## Combination Pliers



Stock No.	Description	Length (mm)	📦	Order No.
WT1014-6	Combination Pliers	160	6	603001
WT1014-7	Combination Pliers	180	6	603002
WT1014-8	Combination Pliers	200	6	603003
WT5414-9	Combination Pliers, Heavy Duty	225	6	603004

- Chrome vanadium steel
- All tools are tested under 10,000 Voltage testing machine
- Special designed soft grips
- Laser hardened cutting edge

## Side Cutter



Stock No.	Description	Length (mm)	📦	Order No.
WT1003-6	Side Cutter	160	6	603007
WT5403-8	Side Cutter	203	6	603008

- Chrome vanadium steel
- All tools are tested under 10,000 Voltage testing machine
- Special designed soft grips
- Laser hardened cutting edge

## Wire Stripping Pliers



Stock No.	Description	Length (mm)	📦	Order No.
WT1017C-6	Wire Stripping Pliers	160	6	603009

- Chrome vanadium steel
- All tools are tested under 10,000 Voltage testing machine
- Special designed soft grips
- Laser hardened cutting edge

## Slip Joint Pliers



Stock No.	Slip Joint Pliers	Length (mm)	📦	Order No.
WT8627-10	Slip Joint Pliers	250	6	603010

- Chrome vanadium steel
- All tools are tested under 10,000 Voltage testing machine
- Special designed soft grips
- Laser hardened cutting edge

# Pliers Locking Pliers

## Straight Jaws



Stock No.	Description	Jaw Capacity (inches)	Length (inches)		Order No.
BDGLP7SAP	Straight Jaws	1 5/16	7	6	604013
BDGLP10SAP	Straight Jaws	1 3/4	10	6	604014

- Exceed ASME specification
- Straight jaws with maximum contact area
- Nickel plated to resist corrosion
- Convenient, one hand release lever

## Straight Jaws, Soft Grip



Stock No.	Description	Jaw Capacity (inches)	Length (inches)		Order No.
BDMLP7SAP	Straight Jaws, Soft Grip	1 5/16	7	6	604015
BDMLP10SAP	Straight Jaws, Soft Grip	1 3/4	10	6	604016

- Exceed ASME specification
- Straight jaws with maximum contact area
- Nickel plated to resist corrosion
- Convenient, one hand release lever
- Non-slip cushion grip

## Chain Style Locking Pliers

Packing: 1



VGP18110  
Order NO.: 604012

Stock No.	Chain Capacity (inches)	Handle Length (inches)
VGP18110	up to 6 9/32	9 27/32

- Wraps around and holds irregular shaped objects like oil filters and mufflers quickly and easily

## C-Clamp Locking Pliers



	Stock No.	Jaw Capacity (inches)	Length (inches)		Order No.
Standard Tip	VGP12406	2 5/16	6	1	807020
	VGP12412	3 5/16	12	1	604011
	VGP12418	10 1/4	18	1	807021
	VGP12424	15 11/16	24	1	807022

	Stock No.	Jaw Capacity (inches)	Length (inches)		Order No.
Swivel Tip	VGP22406	1 5/16	6	1	807023
	VGP22412	3 15/16	12	1	807024
	VGP22418	9 7/16	18	1	807025
	VGP22424	15 11/16	24	1	807026

- Quick and easy handling clamps for autobody and metal fabrication applications
- Spring-loaded release lever permits quick "NO PINCH" release even when tool is firmly locked
- Locking nut allows setting for repetitive jobs

## Locking U-Clamp Pliers

Packing: 1

VGP12509  
Order NO.: 604009



Stock No.	Jaw Capacity (inches)	Length (inches)
VGP12509	2 5/16	9

- U-shaped jaws allow access and perfect visibility when welding
- E-coat provides extra resistance against corrosion and welding splatter
- Quality cold-rolled steel ensures years of service
- Drop forged jaws ensure a tough, durable tool
- Smooth rounded edges allow comfortable handling and reduce risk of injury
- Spring-loaded release lever permits quick "NO PINCH" release even when tool is firmly locked
- Piano wire spring provides smooth jaw opening
- Adjustment bolt features deep knurl to accommodate greasy hands
- Locking nut allows setting for repetitive jobs
- Drilled (not punched) holes in mobile jaw ensure maximum bearing with rivets for smooth action
- Large diameter rivets add strength and durability



# Pliers

Locking Pliers / Retaining Ring Pliers / Special Pliers

## Sheet Metal Locking Pliers

Packing: 1

VGP12808  
Order NO.: 604010



Stock No.	Jaw Capacity (inches)	Length (inches)
VGP12808	1 3/4	8

- Wide jaws allow clamping, bending, forming and crimping of sheet metal without gripping effort
- E-coat provides extra resistance against corrosion and welding splatter
- Quality cold-rolled steel ensures years of service
- Drop forged jaws ensure a tough, durable tool
- Smooth rounded edges allow comfortable handling and reduce risk of injury
- Spring-loaded release lever permits quick "NO PINCH" release even when tool is firmly locked
- Piano wire spring provides smooth jaw opening
- Adjustment bolt features deep knurl to accommodate greasy hands
- Locking nut allows setting for repetitive jobs
- Drilled (not punched) holes in mobile jaw ensure maximum bearing with rivets for smooth action
- Large diameter rivets add strength and durability

## Retaining Ring Pliers, Internal

Packing: 1

PR7  
Order NO.: 605008



Tip Kit Included	Tip Sizes Included	Optional Kits	Optional Tip Sizes
PR7-1	.120", 0°	PR7-2	.120", 45°
Optional Kits	Optional Tip Sizes	Length (inches)	Ring Size Range (inches)
PR7-3	.120", 90°	15 11/16	3 1/16 - 6 1/4

- Retaining ring pliers, interchangeable tip

## Retaining Ring Pliers, External

Packing: 1

PR8  
Order NO.: 605009



Tip Kit Included	Tip Sizes Included	Optional Kits	Optional Tip Sizes
PR7-1	.120", 0°	PR7-2	.120", 45°
Optional Kits	Optional Tip Sizes	Length (inches)	Ring Size Range (inches)
PR7-3	.120", 90°	15 11/16	3 1/16 - 6 1/4

- Retaining ring pliers, interchangeable tip

## Retaining Ring Pliers, Internal

Packing: 1

PR54  
Order NO.: 605010



Tip Kit Included	Tip Sizes Included	Optional Kits	Optional Tip Sizes
PR54-1	.150", 0°	PR54-2	.150", 45°
Optional Kits	Optional Tip Sizes	Length (inches)	Ring Size Range (inches)
PR54-3	.150", 90°	29	6 1/2 - 10

- Retaining ring pliers, interchangeable tip, internal, 29"

## Retaining Ring Pliers, External

Packing: 1

PR53  
Order NO.: 605011



Tip Kit Included	Tip Sizes Included	Optional Kits	Optional Tip Sizes
PR53-1	.170", 0°	PR53-2	.170", 45°
Optional Kits	Optional Tip Sizes	Length (inches)	Ring Size Range (inches)
PR53-3	.170", 90°	19	6 1/2 - 10

- Retaining ring pliers, interchangeable tip, external, 19"

## Bolt Cutter, Heavy Duty



Stock No.	Capacity- (Soft Material) (inches)	Capacity- (Hard Material) (inches)	Length (inches)	Weight (kg)	Packing	Order No.
BLPBC18	3/8	1/4	18	1.55	2	606001
BLPBC24	7/16	5/16	24	2.55	2	606002
BLPBC30	1/2	3/8	30	3.90	1	606003
BLPBC36	9/16	7/16	36	6.45	1	606004

- Ideal for cutting rod, bolts, concrete form ties and fencing wire
- Hardened alloy steel jaws
- Center cut jaw configuration provides balance while cutting
- Cuts soft or hard materials
- Rubber gripped steel handles ensure firm grip during use

## Bolt Cutter Replacement Jaws



Stock No.	Description	Packing	Order No.
BLPBC18-1	Bolt Cutter Replacement Jaws, 18"	1	606005
BLPBC24-1	Bolt Cutter Replacement Jaws, 24"	1	606006
BLPBC30-1	Bolt Cutter Replacement Jaws, 30"	1	606007
BLPBC36-1	Bolt Cutter Replacement Jaws, 36"	1	606008

- Ideal for cutting rod, bolts, concrete form ties and fencing wire
- Hardened alloy steel jaws
- Center cut jaw configuration provides balance while cutting
- Cuts soft or hard materials



# Torque Tools

Our torque wrenches are made in the USA where the best torque products come from.

Each unit is factory calibrated and certified to meet ASME specified accuracy on a torque standard traceable to the National Institute of Standards and Technology.

Designs like the sealed high strength ratchet head keeps out dirt and moisture in the harshest environment giving you a reliable tool that constantly deliver accurate results.

Its internal mechanism is also permanently lubricated during assembly for a trouble free service life.

You can thus be assured of accuracy, reliability and a maintenance-free equipment when getting our torque products.





Adjustable  
Click-Type

72

Preset  
Click-Type

72

Electronic  
Type

74

Digital  
Torque  
Testers

75

# Torque Tools Adjustable Click-Type / Preset Click-Type

## Adjustable Click-Type Torque Wrench

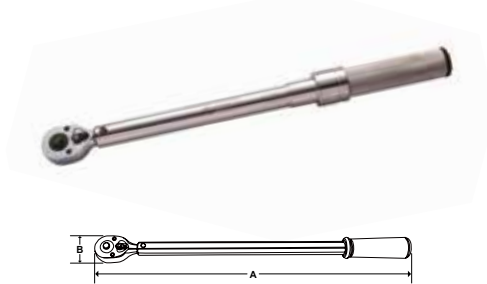

Stock No.	Square Drive (inches)	Range (Nm)	Range (Ft.Lb.)	Increment (Nm)	A (mm)	B (mm)	Weight (g)	Order No.
BP501NMRMH	1/4	1.0 - 5.0	1 - 4	0.06	258	27	386	1 203001
BP2502NMRMH	3/8	4.0 - 27.7	3 - 20	0.12	286	27	431	1 203002
BP602NMRMH	3/8	10 - 60	8 - 45	0.5	406	36	1,134	1 203003
BP1002NMRMH	3/8	20 - 100	15 - 75	0.5	406	36	1,134	1 203004
BP2003NMRMH	1/2	40 - 200	30 - 150	2	483	43	1,474	1 203005
BP3403NMRMH	1/2	60 - 340	45 - 250	2	620	43	1,542	1 203006
BP8004NMRMH	3/4	150 - 800	110 - 600	5	1,067	64	5,375	1 203007
BP15005NMRMH	1	300 - 1500	220 - 1100	10	1,778	76	11,385	1 203008

- Dual scale, calibrated dual direction
- Positive lock with spring loaded pull down lock ring
- Fast, accurate and easy to set
- Easy-to-read laser marked scales
- Most feature quick release buttons which provide good socket retention as well as easy socket removal
- Accuracy: ± 3% CW ± 4% CCW of indicated value, CW, from 20% to 100% of full scale
- Meets or exceeds ASME B107.14-2004, ISO 6789 standards
- Individually serialized with matching certificate of calibration traceable to N.I.S.T.

## Preset Click-Type Torque Wrench



Stock No.	Square Drive (inches)	Range (Nm)	Range (Ft.Lb.)	Range (In.Lb.)	Range (M Kg)	Length (mm)	Weight (g)	Order No.
BP5T-1R	1/4	1.4 - 5.4	1 - 5	12 - 60	0.10 - 0.70	165	227	1 204001
BP10T-2R	3/8	3.9-27.7	3 - 9	36 - 108	0.42 - 1.24	184	397	1 204002
BP50T-2R	3/8	10.2 - 98.3	10 - 50	120 - 600	1.25 - 7.00	292	680	1 204003
BP100T-3R	1/2	34 - 197	45 - 150	540 - 1800	6.00 - 20.00	502	1,247	1 204004
BP200T-3R	1/2	47 - 272	45 - 200	540 - 2400	6.00 - 27.00	603	1,361	1 204005
BP300T-4R	3/4	85 - 400	100 - 300	1200 - 3600	14.00 - 42.00	711	2,155	1 204006
BP600T-4R	3/4	280 - 830	200 - 600	2400 - 7200	28.00 - 83.00	1,321	5,443	1 204007

- Torques in both left and right hand directions
- Accuracy: ± 3% CW ± 4% CCW of indicated value
- Automatic re-set when force on handle is released
- Torque limiting positive sensory "click" when pre-set
- Smooth knurled steel hand hold for comfortable, safe grip
- Handle length proportioned to torque range of wrench for minimum user fatigue
- Tamper proof torque setting for production line use
- Torque values can be calibrated in English and Metric settings
- All parts are made of alloy steel for maximum life and calibration retention
- Square drives meet industrial requirements and government specifications

## Preset Click-Type Torque Wrench, "L" Series



Stock No.	Square Drive (inches)	Range (Nm)	Range (Ft.Lb.)	Length (mm)	Weight (g)	Order No.
BP10T-2RL	3/8	4 - 30	21 - 20.4	184	450	1 204016
BP50T-2RL	3/8	10 - 100	7.3 - 72.2	350	700	1 204017
BP100T-3RL	1/2	35 - 200	25 - 145	530	1220	1 204018
BP200T-3RL	1/2	45 - 280	34.6 - 200	630	1380	1 204019
BP250T-3RL	1/2	60 - 340	44.2 - 250.8	630	1380	1 204020

- A higher performance wrench than similar ones offered by the competitor
- Blue-point ratchet heads are smaller than competitor
- Blue-point 40 tooth ratchet head vs. the competitor; much less "swing arc"
- Blue-point wrench tubes are smaller diameter at the throat; greater access
- Ratchets are bi-directional
- High durability - survived 50,000 cycle testing in both directions; competitor failed at 12,000 cycles
- Improved calibration performance; Blue-point remained calibrated after 25,000 cycles. Competitors wrench fell out of calibration prior to required 5,000 cycles

# Torque Tools Preset Click-Type

## Preset Click-Type Torque Wrench, Interchangeable Head

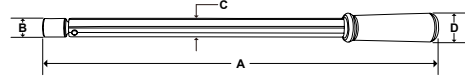

Stock No.	Shank Size	English Range	Range (Nm)	A (mm)	B (mm)	C (mm)	D (mm)	Weight (g)		Order No.
BP5T-I	J	10 - 50 in.lb.	1.1 - 5.6	165	16	15	25	159	1	204008
BP10T-I	J	50 - 250 in.lb.	5.6 - 28	254	16	15	25	249	1	204009
BP10ST-I	J	60 - 300 in.lb.	6.8 - 34	157	17	22	36	340	1	204010
BP50T-I	J	15 - 75 ft.lb.	20 - 102	279	17	22	36	635	1	204011
BP100T-I	Y	30 - 150 ft.lb.	41 - 203	495	24	22	36	1,043	1	204012
BP200T-I	Y	40 - 200 ft.lb.	54 - 271	597	24	22	36	1,179	1	204013
BP300T-I	X	100 - 300 ft.lb.	135 - 406	704	28	25	36	1,769	1	204014
BP600T-I	Z	120 - 600 ft.lb.	162 - 814	1,397	38	32	32	4,740	1	204015

- Eight models available with torque ranges from 10 in. lb. to 600 ft. lb.
- Featuring a durable, non-slip cushion grip
- Uses universal round shank heads
- Audible click and feel impulse torque control mechanism
- Tamper proof torque setting for production line use
- Torque values can be calibrated in english or metric setting
- Accuracy: ± 4% of indicated value, from 20% to 100% of full scale
- Meets or exceeds ASME B107.14-2004, ISO 6789
- Calibration certificate available at additional cost

## Ratcheting Interchangeable Head



Center of fastener to retaining pin:  
 \* J Series - 2.50"  
 \* Y Series - 3.00"  
 \* X Series - 4.50"  
 \* Z Series - 5.75"

Allow use of torque wrench bodies with sockets, crowfoot wrenches, or other similar attachment.

Square Drive (inches)	Shank Size J	Shank Size Y	Shank Size X	Shank Size Z	Head O.D. (mm)	Depth (mm)	Ratchet Service Kit
1/4	QJD8A-72* (350)	—	—	—	3	3.5	RKRT936
3/8	QJD12A* (900)	QYD12A* (1,200)	—	—	17	4.4	RKRF936
1/2	QJD16A* (900)	QYD16A* (2,400)	QXD16A* (3,000)	—	17	4.4	RKRS936
3/4	—	—	QXD24A (3,600)	QZD24B (7,200)	20	4.4	RKRQC4
1	—	—	QXD32A (3,600)	QZD32B (7,200)	20	4.4	RKRQC5

\* U.S. Patent 6,125,722 applies to these ratchet heads  
 Value in parentheses in chart is the Maximum Recommended Working Torque, in. lb.

## Open End Head, mm



mm	Shank Size J	Shank Size Y	Shank Size X	Shank Size Z	Head O.D. (mm)	Head Depth (mm)	mm	Shank Size J	Shank Size Y	Shank Size X	Shank Size Z	Head O.D. (mm)	Head Depth (mm)
6	QJOM6A (60)	—	—	—	13.5	3.6	20	—	QYOM20A (1,925)	QXOM20A (1,925)	—	43.7	9.2
7	QJOM7A (75)	—	—	—	13.5	3.6	21	QJOM21A (900)	QYOM21A (2,160)	QXOM21A (2,160)	—	43.7	9.2
8	QJOM8A (120)	—	—	—	16.5	3.3	22	QJOM22A (900)	QYOM22A (2,400)	QXOM22A (2,470)	—	43.7	9.2
9	QJOM9A (170)	—	—	—	19.8	4.8	23	QJOM23A (900)	QYOM23A (2,400)	QXOM23A (2,745)	—	47	10
10	QJOM10A (265)	—	—	—	19.8	4.8	24	QJOM24A (900)	QYOM24A (2,400)	QXOM24A (2,970)	QZOM24A (2,970)	49	11
11	QJOM11A (400)	—	—	—	22.9	5.6	25	QJOM25A (900)	QYOM25A (2,400)	—	QZOM25A (3,295)	52	11
12	QJOM12A (430)	—	—	—	26.9	6.1	26	QJOM26A (900)	—	QXOM26A (3,570)	QZOM26A (3,570)	53	11
13	QJOM13A (495)	—	—	—	26.9	6.1	27	QJOM27A (900)	QYOM27A (2,400)	—	QZOM27A (3,825)	55	12
14	QJOM14A (665)	QYOM14A (665)	—	—	29.5	6.6	29	—	QYOM29A (2,400)	QXOM29A (3,600)	QZOM29A (4,550)	58	12
15	QJOM15A (885)	QYOM15A (885)	—	—	33.3	6.9	30	—	QYOM30A (2,400)	QXOM30A (3,600)	QZOM30A (4,950)	61	13
16	QJOM16A (900)	QYOM16A (1,060)	—	—	33.3	6.9	32	—	QYOM32A (2,400)	QXOM32A (3,600)	QZOM32A (5,755)	65	14
17	QJOM17A (900)	QYOM17A (1,235)	—	—	37.1	7.3	34	—	QYOM34A (2,400)	QXOM34A (3,600)	QZOM34A (6,595)	68	14
18	QJOM18A (900)	QYOM18A (1,375)	QXOM18A (1,375)	—	37.1	7.3	36	—	QYOM36A (2,400)	QXOM36A (3,600)	QZOM36A (7,200)	74	15
19	QJOM19A (900)	QYOM19A (1,650)	QXOM19A (1,650)	—	40.4	7.6							

Value in parentheses is the Maximum Recommended Working Torque, in. lb.



WARNING



• Do not exceed rated torque • Do not use to break fasteners loose  
 • Periodic recalibration is necessary to maintain accuracy • Read safety precautions on page 162

# Torque Tools Electronic Type

## Computorq 3 Digital Torque Wrench



- Uses CR123 replaceable batteries
- Audible tone indication

## Computorq 3 Digital Torque Wrench

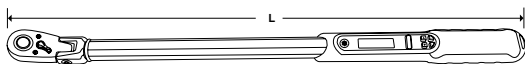

- Sleek new design
- 15-degree flex ratcheting head
- Push button socket release head
- Large, easy to read digital display
- Long battery life, uses 2 each CR123 lithium batteries
- Ergonomically designed molded non-slip rubber grip
- Torques in both clockwise and counterclockwise directions
- Battery saving auto-shutoff after two minutes
- COMPUTORQ 3 remembers last unit and torque setting selected
- Audible tone sounds when set torque value is reached, if the set torque value is exceeded, an alarm tone will sound
- 3 color LED light bar  
YELLOW LED indicates approaching desired torque setting  
GREEN LED indicates desired torque value is reached  
RED LED indicates fastener was overtorqued, loosen and retighten
- When desired torque value is reached, display will hold value and flash for ten seconds
- COMPUTORQ 3 will operate in any of four torque units, foot pounds (ft. lbs.), inch pounds (in. lbs.), newton meter (Nm) or kilogram centimeter (kg. cm.)
- ACCURACY:  
± 2% CW of readings from 10% to 100% of full scale  
± 3% CCW of readings from 20% to 100% of full scale
- N.I.S.T. traceable certificate of calibration included  
Meets or exceeds ASME B107.28 - 2005

Stock No.	Square Drive (inches)	Range (Ft. Lb.)	Range (In. Lb.)	Range (Nm)	Range (Kg. Cm.)	Length (mm)	Weight (g)		Order No.
BP2401CI3	1/4	2.0 - 20.0	24 - 240	2.71 - 27.10	27.6 - 276	381	910	1	205001
BP1002CF3	3/8	10.0 - 100.0	120 - 1200	13.6 - 135.6	138 - 1382	432	1,000	1	205002
BP2503CF3	1/2	25 - 250	300 - 3000	33.8 - 338	345 - 3456	686	1,590	1	205003

# Torque Tools Digital Torque Testers

## Digital Torque Tester



- Integral Transducer and sturdy housing allow mounting in virtually any position
- Integral Transducer: Full bridge strain gage, 350 ohm, 1500uE, 3mV/V F.S, 3.75 excitation
- Units of Torque: Nm, kgcm, ft.lb., in.lb., in-oz.
- Audible (tone)
- Torque Accuracy:  $\pm 0.5\%$   $\pm 1$  count CW and CCW from 10 to 100% of full scale at 25° C
- LCD Touch Screen: 4.7 in. color graphics display
- Screen resolution: 480 X 272 pixels
- Display Accuracy: 4 digits, 500 cycle counts
- Six "AA" Alkaline cells for battery power included
- Track, Peak and First Peak modes of operation
- Operating Temperature: 40 to 110° F (5 to 42° C)
- Storage Temperature: 0 to 122° F (-20 to 50° C)
- Humidity up to 85% non-condensing
- ISO-6789-2003 and ASME B107-28-2005 standards compliant
- Certificate of N.I.S.T. traceability from 10% to 100% of full scale
- Includes storage case, AC adapter and USB cable 110 - 220v
- Dates & times, serial numbers, required accuracy vs actual readings, percentage error & users of torque wrenches tested are stored

Stock No.	Square Drive (inches)	English Range	Range (Nm)		Order No.
BP1001-O-DTT	1/4	10 - 100 in.oz.	0.07 - 0.706	1	206001
BP501-I-DTT	1/4	5 - 50 in.lb.	0.56 - 5.65	1	206002
BP2502-I-DTT	3/8	25 - 250 in.lb.	2.82 - 28.25	1	206003
BP2503-F-DTT	1/2	25 - 250 ft.lb.	33.90 - 338.9	1	206004
BP6004-F-DTT	3/4	60 - 600 ft.lb.	81.35 - 813.5	1	206005
BP10002-I-DTT	3/8	100 - 1000 in.lb.	11.3 - 113	1	206006

## Digital Torque Tester



LCD touchscreen with colour display



Uses disposable batteries and ac adaptor



High accuracy of  $\pm 0.5\%$

- Remembers last 500 cycle counts
- Audible tone signals



# Power Tools





A close-up, side-profile view of a metallic power tool, likely an impact wrench, showing its housing and internal components. The tool is illuminated from the left, creating a bright glow against a dark background.

In making our power tools, we observed the fact that not only has it got to be durable and perform well, it is not much good if you are fighting excess weight, vibration and noise. Basing on this, we come up with a whole range of power tools that embrace these qualities and more.

### **Air**

Our impact wrench feature unique twin hammer impact mechanism to deliver more power per blow. Having more vanes in the rotor also helps in delivering more power as well as a smoother power transfer to the impact hammers. The aluminium alloy housing maintains tool toughness and durability. All these are achieved while keeping weight and vibration to a minimum.

### **Cordless**

Heavy duty components combined with strong and lightweight bodies give our cordless tools more power while being light. Ergonomic grips coupled with vibration absorbing features offer a smoother, more comfortable operation. And long lasting high capacity batteries allow you to work longer with less disruption. The result is a compact power tool that is lightweight, balanced and delivers performance you need.

Air Tools

78

Cordless  
Tools

93

Impact  
Sockets

94

Accessories

102

# Power Tools Air Tools

## 1" Impact Wrench, Heavy Duty

Packing: 1

AT1300A

Order NO.: 701001



AT1300AL (6"long Anvil)

Order NO.: 701002

Drive Size (inches)	Max. Torque (N·m)	Free Speed RPM	Blows per Minute
1	4,068	4,000	505
Air Consumption, Free Speed (L/MIN)	Air Inlet Thread Size	Recommended Hose Size (inches)	Vibration Level (m/s <sup>2</sup> )
150	1/2"-14 NPT	1/2	4.4
Sound Level dBa Pressure	Length (mm)	Weight (kg)	Vinyl Boot (optional)
103	533	11.6	—

- Fast, 4,000 RPM free speed-strong 3,000 ft. lb. maximum torque output
- Workhorse performance for use on trucks, buses and heavy equipment
- Steel nose for rugged, demanding applications
- Pin clutch style impact mechanism for fast startup and high torque requirements

## 3/4" Drive Impact Wrench

Packing: 1

AT670

Order NO.: 701066



Air Inlet Thread Size	Drive Size	Max Torque	Free Speed RPM
3/8"-18 NPT	3/4 in.	1,050 ft. lbs.	6,700

- Aluminium nose with composite body for lightweight & durability
- Twin-hammer mechanism easily removes stubborn nuts
- Three-position lever controls amount of torque
- Two-way push buttons controls Forward/Reverse rotation

## 1/2" Impact Wrench, Soft Handle

Packing: 1

AT555B

Order NO.: 701007



Drive Size (inches)	Max. Torque (N·m)	Free Speed RPM	Blows per Minute
1/2	644(F), 745(R)	6,800 (F), 7,500 (R)	1,000
Air Consumption, Free Speed (L/MIN)	Air Inlet Thread Size	Recommended Hose Size (inches)	Vibration Level (m/s <sup>2</sup> )
62	1/4" -18 NPT	3/8	3.75
Sound Level dBa Pressure	Length (mm)	Weight (kg)	Vinyl Boot (optional)
100	198	2.6	<b>AT555BOOT</b>

- Powerful twin hammer clutch
- Reverse bias air motor provides greater power in reverse when extra breakaway torque is needed
- Built-in power regulator
- Molded ergonomic handle grip
- Quiet Muffler
- Through-handle exhaust

## 1/2" Impact Wrench, Composite Rear Housing

Packing: 1

ATC500

Order NO.: 701009



Drive Size (inches)	Max. Torque (N·m)	Free Speed RPM	Blows per Minute
1/2	712	10,500	1,250
Air Consumption, Free Speed (L/MIN)	Air Inlet Thread Size	Recommended Hose Size (inches)	Vibration Level (m/s <sup>2</sup> )
99	1/4" -18 NPT	3/8	<2.5
Sound Level dBa Pressure	Length (mm)	Weight (kg)	Vinyl Boot (optional)
95.5	198	2.3	<b>IMC500BOOT</b>

- Aluminum front housing and composite rear housing contribute to an extremely durable, lightweight, balanced unit
- Ribbed, textured handle for maximum comfort and control
- Four position power regulator for greater job versatility
- Twin hammer impact mechanism for longer life and greater power

# Power Tools Air Tools

## 1/2" Impact Wrench

Packing: 1

AT123B

Order NO.: 701005



AT123BL (2" Long Anvil)

Order NO.: 701006

Drive Size (inches)	Max. Torque (N·m)	Free Speed RPM	Blows per Minute
1/2	576	9,000	1,000
Air Consumption, Free Speed (L/MIN)	Air Inlet Thread Size	Recommended Hose Size (inches)	Vibration Level (m/s <sup>2</sup> )
79	1/4" -18 NPT	3/8	13
Sound Level dBa Pressure	Length (mm)	Weight (kg)	Vinyl Boot (optional)
108	185	2.6	AT123-45

- Twin hammer impact mechanism provides harder hitting blows
- Steel nose case with lightweight aluminum housing
- Pressure feed grease lubrication
- Convenient slide bar forward/reverse

## 1/2" Composite Impact Wrench

Packing: 1

AT570

Order NO.: 701064



Drive Size (inches)	Max. Torque (N·m)	Free Speed RPM	Blows per Minute
1/2	773	6,900(F), 7,000(R)	1,050
Air Consumption, Free Speed (L/MIN)	Air Inlet Thread Size	Recommended Hose Size (inches)	Vibration Level (m/s <sup>2</sup> )
5.0 cfm(F), 5.3 cfm (rev.)	1/4" -18 NPT	3/8	6.08
Sound Level dBa Pressure	Length (mm)	Weight (kg)	Vinyl Boot (optional)
95	184	1.87	AT570BOOT

- Shot Peen Anvils for improved durability
- Reverse Bias motor provides additional breakaway torque
- 3 position regulator to control power
- One handed forward/reverse lever for user convenience
- Composite housing with aluminum nose combine to deliver a durable, lightweight and balanced unit.
- Twin hammer impact mechanism delivers hard hitting blows to quickly remove stubborn fasteners

## Impact Wrench

1



Twin hammer impact mechanism provides harder hitting blows

2



Steel nose case with lightweight aluminum housing

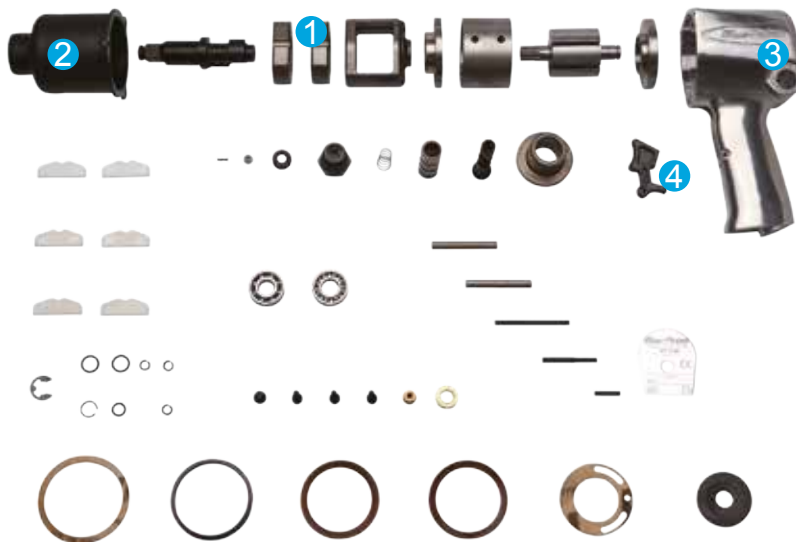

3



Five-position air speed regulator; convenient slide bar forward/reverse

4



Pressure feed grease lubrication

# Power Tools Air Tools

## 3/8" Impact Wrench

Packing: 1



AT380A

Order NO.: 701010

Drive Size (inches)	Max. Torque (N·m)	Free Speed RPM	Blows per Minute
3/8	230	8,700	1,680
Air Consumption, Free Speed (L/MIN)	Air Inlet Thread Size	Recommended Hose Size (inches)	Vibration Level (m/s <sup>2</sup> )
111	1/4" -18 NPT	3/8	3.5
Sound Level dBa Pressure	Length (mm)	Weight (kg)	Vinyl Boot (optional)
94	165	1.36	AT380ABOOT

- 10% more power than the AT380
- Built-in five position adjustable air regulator plus a variable speed trigger for maximum user control
- Aluminum housing provides a lightweight yet durable tool
- Tapered nose increases accessibility to confined areas
- Ball-bearing mounted motor creates a smooth running operation for less user fatigue
- Brass inlet filter screens out dirt and grit; easy-to-remove filter for cleaning
- Twin-hammer impact mechanism designed to hit hard yet offer tool longevity. One-year limited warranty

## 3/8" Impact Wrench, Composite

Packing: 1



AT370

Order NO.:701065

Drive Size (inches)	Max. Torque (N·m)	Free Speed RPM	Blows per Minute
3/8	434	10,000(F), 11,000(R)	1,050
Air Consumption, Free Speed (L/MIN)	Air Inlet Thread Size	Recommended Hose Size (inches)	Vibration Level (m/s <sup>2</sup> )
4.4 cfm(F), 4.7 cfm (R)	1/4" -18 NPT	3/8	3.25
Sound Level dBa Pressure	Length (mm)	Weight (kg)	Vinyl Boot (optional)
92	160	1.19	AT370BOOT

- Shot Peen Anvils for improved durability
- Reverse Bias motor provides additional breakaway torque
- 3 position regulator to control power
- One handed forward/reverse lever for user convenience
- Composite housing with aluminum nose combine to deliver a durable, lightweight and balanced unit.
- Twin hammer impact mechanism delivers hard hitting blows to quickly remove stubborn fasteners

## 3/8" Impact Wrench, Single Hammer

Packing: 1



AT321

Order NO.: 701011

Drive Size (inches)	Max. Torque (N·m)	Free Speed RPM	Blows per Minute
3/8	237	11,000	1,500
Air Consumption, Free Speed (L/MIN)	Air Inlet Thread Size	Recommended Hose Size (inches)	Vibration Level (m/s <sup>2</sup> )
108	1/4" -18 NPT	3/8	9.8
Sound Level dBa Pressure	Length (mm)	Weight (kg)	Vinyl Boot (optional)
109	155	1.3	AT321-44

- Single hammer impact mechanism
- Steel nose case with lightweight aluminum housing
- Convenient slide bar forward/reverse

## 3/8" Impact Wrench, Compact

Packing: 1



AT351

Order NO.:701013

Drive Size (inches)	Max. Torque (N·m)	Free Speed RPM	Blows per Minute
3/8	237	9,700	1,200
Air Consumption, Free Speed (L/MIN)	Air Inlet Thread Size	Recommended Hose Size (inches)	Vibration Level (m/s <sup>2</sup> )
71	1/4" -18 NPT	3/8	3.09
Sound Level dBa Pressure	Length (mm)	Weight (kg)	Vinyl Boot (optional)
109.2	194	1.2	—

- Built-in air inlet swivel
- 8 position power regulator
- Rotary action air motor is ball bearing mounted for balance, speed and power
- Ideal tool for small engine repair and bench work

# Power Tools Air Tools

## 1/4" Impact Wrench, Mini

Packing: 1

AT235MCA  
Order NO.: 701014



Drive Size (inches)	Max. Torque (N·m)	Free Speed RPM	Blows per Minute
1/4	34	13,000	2,900
Air Consumption, Free Speed (L/MIN)	Air Inlet Thread Size	Recommended Hose Size (inches)	Vibration Level (m/s <sup>2</sup> )
47	1/4" -18 NPT	3/8	<2.5
Sound Level dBa Pressure	Length (mm)	Weight (kg)	Vinyl Boot (optional)
95.1	158	64	—

- Composite housing contributes to an extremely durable, lightweight unit with new molded comfort grip
- Composite housing is not cold to the touch
- Forward/Reverse mechanism easily operated with one-finger
- Large, variable speed trigger for control
- Exhaust is from the handle bottom, keeping exhaust away from work area and user

## 1/2" Ratchet

Packing: 1

AT705B  
Order NO.: 701015



Drive Size (inches)	Torque Range (N·m)	Free Speed RPM	Air Consumption, Free Speed (L/MIN)
1/2	6 - 68	150	85
Air Inlet Thread Size	Recommended Hose Size (inches)	Vibration Level (m/s <sup>2</sup> )	Sound Level dBa Pressure
1/4"-18 NPT	3/8	8.7	89
Length (mm)	Weight (kg)	Vinyl Boot (included)	
273	1.14	<b>AT700E49A</b>	

- 1/2" drive ratchet in a 3/8" drive body
- Delivers 50 ft. lb. of maximum torque
- Ball bearing mounted motor for longer tool life

## 3/8" Ratchet

Packing: 1

AT704A  
Order NO.: 701016



Drive Size (inches)	Torque Range (N·m)	Free Speed RPM	Air Consumption, Free Speed (L/MIN)
3/8	6 - 75	200	111
Air Inlet Thread Size	Recommended Hose Size (inches)	Vibration Level (m/s <sup>2</sup> )	Sound Level dBa Pressure
1/4" -18 NPT	3/8	<3.9	104
Length (mm)	Weight (kg)	Vinyl Boot (included)	
266	1.5	—	

- Lightweight aluminum housing
- Rugged ball bearing mounted air motor and precision planetary gear system
- Easy to use variable speed throttle plus adjustable air regulator

## 3/8" Ratchet, High Torque

Packing: 1

AT702  
Order NO.: 701018



Drive Size (inches)	Torque Range (N·m)	Free Speed RPM	Air Consumption, Free Speed (L/MIN)
3/8	6 - 81	200	85
Air Inlet Thread Size	Recommended Hose Size (inches)	Vibration Level (m/s <sup>2</sup> )	Sound Level dBa Pressure
1/4"-18 NPT	3/8	12.6	95
Length (mm)	Weight (kg)	Vinyl Boot (included)	
265	1.1	<b>AT700E49A</b>	

- Flywheel mechanism
- Rugged ball bearing mounted air motor coupled with precision planetary gear system
- Easy to use variable speed throttle and adjustable air regulator



# Power Tools Air Tools

## 3/8" Ratchet

Packing: 1

AT738

Order NO.: 701019



Drive Size (inches)	Torque Range (N·m)	Free Speed RPM	Air Consumption, Free Speed (L/MIN)
3/8	0 - 81	300	113
Air Inlet Thread Size	Recommended Hose Size (inches)	Vibration Level (m/s <sup>2</sup> )	Sound Level dBa Pressure
1/4" -18 NPT	3/8	5.9	102
Length (mm)	Weight (kg)	Vinyl Boot (included)	
285	1.3	<b>AT738BOOT</b>	

- Reactionless mechanism absorbs kickback when running fasteners tight
- High RPM removes fasteners quickly
- Adjustable air regulator
- Ideal tool for spark plugs, water pumps, shocks and muffler clamps

## 3/8" Ratchet

Packing: 1

AT700F

Order NO.: 701017



Drive Size (inches)	Torque Range (N·m)	Free Speed RPM	Air Consumption, Free Speed (L/MIN)
3/8	6 - 61	150	85
Air Inlet Thread Size	Recommended Hose Size (inches)	Vibration Level (m/s <sup>2</sup> )	Sound Level dBa Pressure
1/4" -18 NPT	3/8	8.7	89
Length (mm)	Weight (kg)	Vinyl Boot (included)	
257	1.6	<b>AT700E49A</b>	

- Lightweight aluminum housing
- Rugged ball bearing mounted air motor and precision planetary gear system
- Easy to use variable speed throttle plus adjustable air regulator

## 1/4" Ratchet

Packing: 1

AT203A

Order NO.: 701020



Drive Size (inches)	Torque Range (N·m)	Free Speed RPM	Air Consumption, Free Speed (L/MIN)
1/4	6 - 34	285	88
Air Inlet Thread Size	Recommended Hose Size (inches)	Vibration Level (m/s <sup>2</sup> )	Sound Level dBa Pressure
1/4" -18 NPT	3/8	<4.4	100
Length (mm)	Weight (kg)	Vinyl Boot (included)	
188	57	—	

- Lightweight aluminum housing
- Rugged ball bearing mounted air motor and precision planetary gear system
- Easy to use variable speed throttle plus adjustable air regulator

## 1/4" Ratchet

Packing: 1

AT200D

Order NO.: 701021



Drive Size (inches)	Torque Range (N·m)	Free Speed RPM	Air Consumption, Free Speed (L/MIN)
1/4	6 - 27	150	40
Air Inlet Thread Size	Recommended Hose Size (inches)	Vibration Level (m/s <sup>2</sup> )	Sound Level dBa Pressure
1/4" -18 NPT	3/8	3.3	85
Length (mm)	Weight (kg)	Vinyl Boot (included)	
222	50	<b>AT200D22A</b>	

- Lightweight aluminum housing
- Rugged ball bearing mounted air motor and precision planetary gear system

# Power Tools Air Tools

## 1/4" Ratchet, Mini

Packing: 1

AT204

Order NO.: 701022



Drive Size (inches)	Torque Range (N·m)	Free Speed RPM	Air Consumption, Free Speed (L/MIN)
1/4	6 - 30	275	68
Air Inlet Thread Size	Recommended Hose Size (inches)	Vibration Level (m/s <sup>2</sup> )	Sound Level dBa Pressure
1/4"-18 NPT	3/8	<1.7	91
Length (mm)	Weight (kg)	Vinyl Boot (included)	
127	66	—	

- Ideal for working in tight quarters
- Head clearance is less than 3/4"
- Includes variable speed trigger, adjustable air regulator and 5' nylon braided whip hose for maneuverability and control
- Polished aluminum housing provides strength and durability

## Spotweld Drill

Packing: 1

AT184

Order NO.: 701023



Chuck Size (inches)	Rated Power (kW)	Torque Range (N·m)	Free Speed RPM
5/16	—	—	1,800
Air Consumption, Free Speed (L/MIN)	Air Inlet Thread Size	Recommended Hose Size (inches)	Vibration Level (m/s <sup>2</sup> )
238	1/4"-18 NPT	3/8	<1.0
Sound Level dBa Pressure	Length (mm)	Weight (kg)	Spotweld Drill Bit (8mm) (included)
84	201	1.4	<b>AT183-50</b>
Spotweld Drill Bit (6.5mm) (optional)	Support Arm 5.5 (optional)	Spotweld Drill Bit (10mm) (optional)	
<b>AT183-43</b>	<b>AT184-26A</b>	<b>AT183-51</b>	

- Twist depth control collar allows precise setting of drilling depth up to 1/4"
- Two speed trigger for low or high speeds
- Pistol grip design
- Includes one 5/16" (8 mm) drill bit and removeable clamp arm

## 1/2" Drill

Packing: 1

AT5000

Order NO.: 701024



Chuck Size (inches)	Rated Power (kW)	Torque Range (N·m)	Free Speed RPM
1/2	0.33	0 - 14	490
Spindle Thread (inches)	Air Consumption, Free Speed (L/MIN)	Air Inlet Thread Size	Recommended Hose Size (inches)
1/2 -20 UNF	108	1/4" -18 NPT	3/8
Vibration Level (m/s <sup>2</sup> )	Sound Level dBa Pressure	Length (mm)	Weight (kg)
<2.5	82	229	1.7
Auxiliary Handle		Vinyl Boot (optional)	
<b>PDAH1A</b>		<b>AT5000BOOT</b>	

- One hand forward/reverse operation
- Three planet gear design for durability and balance
- Bottom handle diffused exhaust
- Comfort grip handle
- Keyed chuck easily handles 120 in. lbs. of torque
- Chuck key stores in handle

## 3/8" Drill

Packing: 1

AT3000

Order NO.: 701025



Chuck Size (inches)	Rated Power (kW)	Torque Range (N·m)	Free Speed RPM
3/8	0.15	0 - 4	2,000
Spindle Thread (inches)	Air Consumption, Free Speed (L/MIN)	Air Inlet Thread Size	Recommended Hose Size (inches)
3/8 -24 UNF	99	1/4" -18 NPT	3/8
Vibration Level (m/s <sup>2</sup> )	Sound Level dBa Pressure	Length (mm)	Weight (kg)
<2.5	105	194	1.4
Auxiliary Handle		Vinyl Boot (optional)	
—		<b>AT3000BOOT</b>	

- One hand forward/reverse operation
- Three planet gear design for durability and balance
- Bottom handle diffused exhaust
- Comfort grip handle
- Keyless chuck saves time when changing bits

# Power Tools Air Tools

## 3/8" Drill, Angle

Packing: 1

AT811

Order NO.: 701026



Chuck Size (inches)	Rated Power (kW)	Torque Range (N·m)	Free Speed RPM
3/8	0.19	0 - 6	1,320
Spindle Thread (inches)	Air Consumption, Free Speed (L/MIN)	Air Inlet Thread Size	Recommended Hose Size (inches)
3/8 -24 UNF	95	1/4" -18 NPT	3/8
Vibration Level (m/s <sup>2</sup> )	Sound Level dBa Pressure	Length (mm)	Weight (kg)
<0.8	110	208	1.1

- Rugged, reversible right angle drill gets in tight spots comfortably
- Convenient one hand push button forward/reverse
- Rear exhaust keeps air away from the work area
- Built in chuck key holder keeps the key at hand for quick bit changes
- Paddle style trigger for greater comfort
- Ball bearing construction for longer tool life
- Lightweight helps avoid fatigue during prolonged use
- Bottom handle diffuse exhaust

## 1/4" Drill, Micro

Packing: 1

AT801MCA

Order NO.: 701027



Chuck Size (inches)	Rated Power (kW)	Torque Range (N·m)	Free Speed RPM
1/4	0.19	0 - 2	1,800
Spindle Thread (inches)	Air Consumption, Free Speed (L/MIN)	Air Inlet Thread Size	Recommended Hose Size (inches)
3/8 -24 UNF	266	1/4" -18 NPT	3/8
Vibration Level (m/s <sup>2</sup> )	Sound Level dBa Pressure	Length (mm)	Weight (kg)
<2.5	96.4	183	0.68

- Composite housing with new molded comfort grip is more comfortable for the user while providing less user fatigue
- Small size, light weight and a powerful motor make this tool ideal for working in confined areas
- Durable single piece polymer composite housing stands up to rugged use, resists most shop chemicals and helps insulate against the cold generated by an air tool
- Variable speed trigger

## Hammer

Packing: 1

AT2050

Order NO.: 701028



Bore Diameter (inches)	Blows per Minute	Piston Stroke (inches)	Shank Opening (mm)	
3/4	3,400	2.75	10.1	
Air Consumption, Free Speed (L/MIN)	Air Inlet Thread Size	Recommended Hose Size (inches)	Vibration Level (m/s <sup>2</sup> )	
71	1/4" -18 NPT	5/16	3.0	
Vibration Level (m/s <sup>2</sup> )	Sound Level dBa Pressure	Length (mm)	Weight (kg)	Vinyl Boot (optional)
3	99	187	2.1	AT2050BOOT

- Intended for heavy duty applications such as cutting large bolts and rivets, separating ball joints, cutting heavy gauge sheet metal and driving bushings
- Comfort grip handle
- Includes quick change retainer

## 1/4" Die Grinder, Standard

Packing: 1

AT115

Order NO.: 701029



Collet Size (inches)	Rated Power (kW)	Free Speed RPM	Air Consumption, Free Speed (L/MIN)
1/4 (6.35mm)	0.15	22,000	113
Air Inlet Thread Size	Recommended Hose Size (inches)	Vibration Level (m/s <sup>2</sup> )	Sound Level dBa Pressure
1/4" -18 NPT	3/8	<2.5	102
Length (mm)		Weight (kg)	
165		0.61	

- Intended for most standard deburring operations
- Ergonomic handle grip increases comfort and control
- Safety lever throttle
- Built-in speed regulator
- Brass bearing cap and hose adaptor
- Rear diffused exhaust



# Power Tools Air Tools

## 1/4" Die Grinder, Right Angle Mini

Packing: 1

AT118  
Order NO.: 701030



Collet Size (inches)	Rated Power (kW)	Free Speed RPM	Air Consumption, Free Speed (L/MIN)
1/4 (6.35mm)	0.15	20,000	59
Air Inlet Thread Size	Recommended Hose Size (inches)	Vibration Level (m/s <sup>2</sup> )	Sound Level dBa Pressure
1/4" -18 NPT	3/8	2.5	104
Length (mm)		Weight (kg)	
140		0.50	

- Clean dies, rotors, backing plates and brake pad mounts
- Remove gasket material
- Grind dies and valve seats
- Dress welds and enlarge holes
- Compact mini-design with 90° angled head for easy access
- Ergonomic handle grip increases comfort and control
- Safety lever throttle
- Built-in speed regulator
- Brass bearing cap and hose adaptor

## 1/4" Die Grinder, Right Angle Mini

Packing: 1

AT109  
Order NO.: 701032



Collet Size (inches)	Rated Power (kW)	Free Speed RPM	Air Consumption, Free Speed (L/MIN)
1/4 (6.35mm)	0.15	20,000	59
Air Inlet Thread Size	Recommended Hose Size (inches)	Vibration Level (m/s <sup>2</sup> )	Sound Level dBa Pressure
1/4" -18 NPT	3/8	2.5	104
Length (mm)		Weight (kg)	
140		0.50	

- Aluminum housing for long lasting durability
- Compact mini design with 90° head for easy access
- High quality bearings improve productivity with less repair
- Rear exhaust directs air away from work area

## 1/4" Die Grinder, Standard

Packing: 1

AT105  
Order NO.: 701031



Collet Size (inches)	Rated Power (kW)	Free Speed RPM	Air Consumption, Free Speed (L/MIN)
1/4 (6.35mm)	0.15	22,000	113
Air Inlet Thread Size	Recommended Hose Size (inches)	Vibration Level (m/s <sup>2</sup> )	Sound Level dBa Pressure
1/4" -18 NPT	3/8	<2.5	102
Length (mm)		Weight (kg)	
165		0.61	

- Aluminum housing for long lasting durability
- Intended for most standard deburring operations
- High quality bearings improve productivity with less repair
- Rear exhaust directs air away from work area

## Die Grinder Kit

Packing: 1

AT109DGK  
Order NO.: 701033



Rated Power (kW)	Free Speed RPM	Air Consumption, Free Speed (L/MIN)	Air Inlet Thread Size	
0.15	20,000	59	1/4" -18 NPT	
Recommended Hose Size (inches)	Vibration Level (m/s <sup>2</sup> )	Sound Level dBa Pressure	Length (mm)	Weight (kg)
3/8	2.5	104	140	0.50

- Aluminum housing
  - Compact mini design
  - Rear exhaust
- Includes: AT109 mini angle die grinder plus 2" (50.8mm) ROLOC® pad (1 ea.), 2" (50.8mm) coarse discs (2 ea.), 2" (50.8mm) medium discs (2 ea.), 2" (50.8mm) 24 grit discs (2 ea.), 2" (50.8mm) 36 grit discs (2 ea.), 2" (50.8mm) crud discs (2 ea.), 3" (76.2mm) ROLOC® pad (1 ea.), 3" (76.2mm) 50 grit discs (2 ea.), 3" (76.2mm) 120 grit discs (2 ea.), 3" (76.2mm) crud discs (2 ea.), 1/4" shank adaptor (1 ea.) and spanner wrenches (2 ea.) in storage case

# Power Tools Air Tools

## 1/4" Die Grinder, Mini

Packing: 1



AT119  
Order NO.: 701034

Recommended Air Pressure, psig (kPa)	Air Consumption, Free Speed (L/MIN)	Free Speed RPM
620	85	20,000
Sound Level, free speed, dBa	Collet Size (inches)	Overall Length, inches (mm)
100	1/4	165

- 115 degree offset head provides a more ergonomic grinding position
- Thread-on style disc provides a more compact head
- One 2" quick-change disc included so tool is ready for your abrasive pad

## Die Grinder Kit

Packing: 1



AT119DGK  
Order NO.: 701035

Rated Power (kW)	Free Speed RPM	Air Consumption, Free Speed (L/MIN)	Air Inlet Thread Size
33	2,000	59	1/4" -18 NPT
Recommended Hose Size (inches)	Vibration Level (m/s <sup>2</sup> )	Sound Level dBa Pressure	Length (mm)
3/8	<6.92	100	173

- Thread-on style disc provides a more compact head than collet style units
- 115° offset head provides a more ergonomic grinding position
- Ideal for cleaning dies, rotors, backing plates and gasket material  
Includes: 115° Mini Offset Angle Die Grinder plus: 2" (50.8mm) ROLOC® pad (1 ea.), 2" (50.8mm) coarse discs (2 ea.), 2" (50.8mm) medium discs (2 ea.), 2" (50.8mm) 24 grit discs (2 ea.), 2" (50.8mm) 36 grit discs (2 ea.), 2" (50.8mm) crud discs (2 ea.), 3" (76.2mm) ROLOC® pad (1 ea.), 3" (76.2mm) coarse discs (2 ea.), 3" (76.2mm) medium discs (2 ea.), 3" (76.2mm) 50 grit discs (2 ea.), 3" (76.2mm) 120 grit discs (2 ea.), 3" (76.2mm) crud discs (2 ea.), and spanner wrench (1 ea.) in storage case

## Die Grinder, Pencil

Packing: 1



AT1070A  
Order NO.: 701036

Collet Size (inches)	Rated Power (kW)	Free Speed RPM	Air Consumption, Free Speed (L/MIN)
1/8 (3.18mm)	—	75,000	28
Air Inlet Thread Size	Recommended Hose Size (inches)	Vibration Level (m/s <sup>2</sup> )	Sound Level dBa Pressure
1/4" -18 NPT	3/8	2.0	72
Length (mm)	Weight (kg)		
135	0.25		

- Twist-action variable speed control
- 5' (1.5 M) long protected air hose
- Used with 1/8" shank grinding accessories higher than 5,4000 RPM
- Ideal for tight spaces and easy cleaning of dies, rotors and brake pads

## Die Grinder, Pencil, Right Angle

Packing: 1



AT1070RA  
Order NO.: 701037

Collet Size (inches)	Rated Power (kW)	Free Speed RPM	Air Consumption, Free Speed (L/MIN)
1/8 (3.18mm)	—	75,000	28
Air Inlet Thread Size	Recommended Hose Size (inches)	Vibration Level (m/s <sup>2</sup> )	Sound Level dBa Pressure
1/4" -18 NPT	3/8	2.0	72
Length (mm)	Weight (kg)		
150	0.21		

- Right angle lightweight pencil die grinder is ideal for getting in tight spaces
- Use for easy cleaning of dies, rotors, backing plates, brake pads, mounts plus many other applications
- Must be used with 1/8" shank grinding accessories rated higher than 70,000 RPM

# Power Tools Air Tools

## 4" Extended Cut-off Tool

Packing: 1

AT154

Order NO.: 701068



Wheel Size (inches)	Rated Power (kW)	Free Speed RPM	Air Consumption, Free Speed (L/MIN)
4	0.5	15,000	113.3
Air Inlet Thread Size	Recommended Hose Size (inches)	Vibration Level (m/s <sup>2</sup> )	Sound Level dBa Pressure
1/4" -18 NPT	3/8	< 2.86	85
Length (mm)	Weight (kg)	4" Cutter Wheels (46 grit) (optional)	
348	1.95	AT154RWHLMP	

- Overall tool length of 14.8 in. provides extended reach for easier access
- Powerful 0.7 hp motor for maximum performance when cutting under a load
- Built-in regulator permits easy speed adjustment to a maximum free speed of 15,000 RPM
- Side handle offers additional tool control

## 3" Cut-off Tool, Reversible

Packing: 1

AT157R

Order NO.: 701039



Wheel Size (inches)	Rated Power (kW)	Free Speed RPM	Air Consumption, Free Speed (L/MIN)
3	0.33	20,000	99
Air Inlet Thread Size	Recommended Hose Size (inches)	Vibration Level (m/s <sup>2</sup> )	Sound Level dBa Pressure
1/4" -18 NPT	3/8	<3.8	100
Length (mm)	Weight (kg)	3" Cutter Wheels (36 grit) (optional)	3" Cutter Wheels (54 grit) (optional)
185	0.86	AT150-20A	AT150-29A

- Reversible 3" cut-off tool is ideal for use in body shops and other general automotive applications
- Recommended for cutting mufflers, hose clamps, bolts and sheet metal
- Spark direction control
- Safety throttle lever
- Rear diffused exhaust
- Comfort grip handle
- Uses wheels only rated above 18,000 RPM

## 3" Cut-off Tool

Packing: 1

AT153

Order NO.: 701067



Wheel Size (inches)	Rated Power (kW)	Free Speed RPM	Air Consumption, Free Speed (L/MIN)	Air Inlet Thread Size
3	0.37	17,000	99.1	1/4" -18 NPT
Recommended Hose Size (inches)	Vibration Level (m/s <sup>2</sup> )	Sound Level dBa Pressure	Length (mm)	Weight (kg)
3/8	< 2.86	85	218.4	1.5
3" Cutter Wheels 1/16" thick (36 grit)(optional)		3" Cutter Wheels 1/32" thick (54 grit)(optional)		3" Cutter Wheels 3/32" thick (54 grit)(optional)
AT150-20A		AT150C28A		AT150C29A

- Its compact size is excellent for accessing areas with limited working space
- Heavy-duty bevel gears for tool longevity
- Indexing adjustable guard controls the direction of sparks
- Spindle lock eliminates the need for special wrenches for fast change of cutoff wheels
- Adjustable built-in regulator easily adjusts up to 17,000 RPM free speed

## 4 1/2" Grinder, Compact

Packing: 1

AT415B

Order NO.: 701041



Wheel Size (inches)	Rated Power (kW)	Free Speed RPM	Air Consumption, Free Speed (L/MIN)
4 1/2	0.64	12,000	91
Air Inlet Thread Size	Recommended Hose Size (inches)	Vibration Level (m/s <sup>2</sup> )	Sound Level dBa Pressure
1/4" -18 NPT	3/8	5.1	87
Length (mm)	Weight (kg)	Grinding Disc	
254	1.9	AT415A51	

- 4 1/2" Compact grinder
- Includes (1) 4 1/2" diameter x 3/16" thick grinding disc

# Power Tools Air Tools

## 2" Grinder, Angle

Packing: 1

AT215

Order NO.: 701042



Wheel Size (inches)	Rated Power (kW)	Free Speed RPM	Air Consumption, Free Speed (L/MIN)
2	0.37	15,000	85
Air Inlet Thread Size	Recommended Hose Size (inches)	Vibration Level (m/s <sup>2</sup> )	Sound Level dBa Pressure
1/4" -18 NPT	3/8	<2.86	73
Length (mm)	Weight (kg)	Grinding Disc (optional)	
188	0.82	<b>AT215GWSET</b>	

- Ideal for body shops, automobile, truck repair and confined areas
- Grease fitting in head-enables gears to be greased for longer tool life
- Includes 6-2" wheels-tool is ready for use providing convenience
- Moveable guard, up to 50° in either direction-fitting various applications
- Built in speed regulator-allows user to set desired speed
- Rear exhaust with rotating deflector
- Comfort grip housing-insulate from cold and vibration for less user fatigue
- Safety lever throttle-prevents accidental start ups for increased safety

## Reciprocating Saw

Packing: 1

AT192A

Order NO.: 701043



Free Speed RPM	Air Consumption, Free Speed (L/MIN)	Air Inlet Thread Size	Recommended Hose Size (inches)
11,000	28	1/4" -18 NPT	3/8
Vibration Level (m/s <sup>2</sup> )	Sound Level dBa Pressure	Length (mm)	Weight (kg)
10.1	94	235	0.80
Bi-Metal Blade, 18TPI, 3 3/4" long (qty. 5)	Bi-Metal Blade, 32TPI, 3 3/4" long (qty. 5)	Bi-Metal Blade, 24TPI, 3 3/4" long (qty. 5)	
<b>AT190-39A</b>	<b>AT190-41A</b>	<b>AT190-40A</b>	

- Adjustable blade guard to control cutting depth
- Comfort grip housing for greater control
- Performs straight or scroll cuts in metal and plastic
- Safety lever throttle
- Includes three 3 3/4" bi-metal blades: (1) 18TPI coarse, (1) 24TPI medium and (1) 32 TPI fine blade
- Optional blades in 4" lengths are also available

## Reciprocating Saw, Micro

Packing: 1

AT194A

Order NO.:701044



Free Speed RPM	Air Consumption, Free Speed (L/MIN)	Air Inlet Thread Size	Recommended Hose Size (inches)
8,250	20	1/4" -18 NPT	3/8
Vibration Level (m/s <sup>2</sup> )	Sound Level dBa Pressure	Length (mm)	Weight (kg)
<6.6	87	175	0.45
Bi-Metal Blade, 18TPI, 3 3/4" long (qty. 5)	Bi-Metal Blade, 32TPI, 3 3/4" long (qty. 5)	Bi-Metal Blade, 24TPI, 3 3/4" long (qty. 5)	
<b>AT190-39A</b>	<b>AT190-41A</b>	<b>AT190-40A</b>	

- Compact size for easy access in tight quarters
- Low vibration level and lightweight yields reduced hand fatigue
- Performs straight or scroll cuts on metal or plastic
- Adjustable blade guard to control cutting depth
- Flexible, guarded hose extension helps prevent damage to finished surface and aids in maneuverability
- Includes three 3 3/4" bi-metal blades: (1) 18TPI coarse, (1) 24TPI medium and (1) 32 TPI fine blade, blade change wrenches and guard adjustment
- Safety trigger prevent accidental start

## Dual Punch Tool

Packing: 1

AT185

Order NO.: 701045



Free Speed RPM	Air Consumption, Free Speed (L/MIN)	Air Inlet Thread Size	Recommended Hose Size (inches)
—	320	1/4" -18 NPT	3/8
Vibration Level (m/s <sup>2</sup> )	Sound Level dBa Pressure	Length (mm)	Weight (kg)
<2.5	48.6	235	1.2

- Paddle style trigger for maximum control
- Handle exhaust directed away from operator
- Ball bearing mounted rotary air motor for long service
- Built-in speed regulator provides torque control
- Removable brass filter screens out dirt and debris
- Use to make 3/16" and 5/16" punches in light sheet metal
- Head swivels 360° for maximum versatility

# Power Tools Air Tools

## Powered Shears

Packing: 1



AT195

Order NO.: 701046

Free Speed RPM	Air Consumption, Free Speed (L/MIN)	Air Inlet Thread Size	Recommended Hose Size (inches)
—	113	1/4" -18 NPT	3/8
Vibration Level (m/s <sup>2</sup> )	Sound Level dBa Pressure	Length (mm)	Weight (kg)
<2.5	99.6	254	1.3

- Trims, outlines and shears
- Replaceable brass filter screen
- Built in speed regulator provide

## 8" Sander, Dual Action

Packing: 1



AT408

Order NO.: 701048

Pad Size (inches)	Rated Power (kW)	Free Speed RPM	Spindle Thread (inches)
8	37	850	5/16 -24
Air Consumption, Free Speed (L/MIN)	Air Inlet Thread Size	Recommended Hose Size (inches)	Vibration Level (m/s <sup>2</sup> )
142	1/4" -18 NPT	3/8	3.7
Sound Level dBa Pressure	Length (mm)	Weight (kg)	Standard Pad
87	281	2.18	<b>AT408-2</b>

- Comfort handle helps reduce fatigue
- Rear diffused exhaust
- Built in adjustable speed regulator
- Variable speed control
- Removable brass filter screens out debris

## Nibbler

Packing: 1



AT180C

Order NO.: 701047

Free Speed RPM	Air Consumption, Free Speed (L/MIN)	Air Inlet Thread Size	Recommended Hose Size (inches)
3,500	113	1/4" -18 NPT	3/8
Vibration Level (m/s <sup>2</sup> )	Sound Level dBa Pressure	Length (mm)	Weight (kg)
4.3	97	194	0.88

- Cuts mild steel sheet up to 16 gauge (0.62") (1.55mm) thick
- Anvil is adjustable for forward, backward and left or right cutting, enabling the nibbler to make sheet metal cuts of any configuration
- Readily cuts most non-ferrous materials including aluminum, brass, formica, laminates, fiberglass and masonite
- Includes AT180B-10 Standard Punch

## 6" Sander, Dual Action

Packing: 1



AT411A

Order NO.: 701049

Pad Size (inches)	Rated Power (kW)	Free Speed RPM	Spindle Thread (inches)
6	0.37	10,000	5/16 -18
Air Consumption, Free Speed (L/MIN)	Air Inlet Thread Size	Recommended Hose Size (inches)	Vibration Level (m/s <sup>2</sup> )
142	1/4" -18 NPT	3/8	3.7
Sound Level dBa Pressure	Length (mm)	Weight (kg)	Standard Pad
79	203	2.14	<b>AT411A-1</b>

- For fine sanding operations and swirl free finishing

# Power Tools Air Tools

## 5" Sander

Packing: 1

AT425R  
Order NO.: 701053



Pad Size (inches)	Rated Power (kW)	Free Speed RPM	Spindle Thread (inches)
5	0.33	13,000	<sup>7</sup> / <sub>16</sub> -20
Air Consumption, Free Speed [L/MIN]	Air Inlet Thread Size	Recommended Hose Size (inches)	Vibration Level (m/s <sup>2</sup> )
122	<sup>1</sup> / <sub>4</sub> " -18 NPT	<sup>3</sup> / <sub>8</sub>	<0.8
Sound Level dBa Pressure	Length (mm)	Weight (kg)	Standard Pad
93	135	1.28	<b>AT425R-24</b>
3" Replacement Pad (Optional)		4" Replacement Pad (Optional)	
<b>AT425R-22</b>		<b>AT425R-23</b>	

- Use in body shops and other general automotive applications
- Includes 3", 4" and 5" backing discs
- One hand reverse
- Comfort grip handle
- Built-in speed regulator
- 1 year limited warranty on tool
- No warranty on consumables
- CE-DE, ES, FR, IT, GB



## In Line Sander, Heavy Duty

Packing: 1

AT475A  
Order NO.: 701054



Rated Power (kW)	Free Speed RPM	Air Consumption, Free Speed (L/MIN)	Air Inlet Thread Size
—	1,800	65	<sup>1</sup> / <sub>4</sub> " -18 NPT
Recommended Hose Size (inches)	Vibration Level (m/s <sup>2</sup> )	Sound Level dBa Pressure	Length (mm)
<sup>3</sup> / <sub>8</sub>	14.9	87	406
Weight (kg)	Standard Pad		
3.09	<b>AT475A-29</b>		

- 5/8" stroke
- Minimal vibration

# Power Tools Air Tools

## Jitterbug Sander

Packing: 1

AT435A

Order NO.: 701055



Rated Power (kW)	Free Speed RPM	Air Consumption, Free Speed (L/MIN)	Air Inlet Thread Size
0.37	8,000	85	1/4" -18 NPT
Recommended Hose Size (inches)	Vibration Level (m/s <sup>2</sup> )	Sound Level dBa Pressure	Length (mm)
3/8	4.5	84	171
Weight (kg)		Standard Pad	
2.09		AT435A-48	

- Features top mounted throttle

## 3" Surface Prep Tool, Micro

Packing: 1

AT401MCA

Order NO.: 701056



Pad Size (inches)	Rated Power (kW)	Free Speed RPM	Spindle Thread (inches)
3	0.19	15,000	1/4 -20
Air Consumption, Free Speed (L/MIN)	Air Inlet Thread Size	Recommended Hose Size (inches)	Vibration Level (m/s <sup>2</sup> )
59	1/4" -18 NPT	3/8	<2.5
Sound Level dBa Pressure	Length (mm)	Weight (kg)	
84	119	0.44	

- Small size, light weight and a powerful motor make the AT401MCA
- Surface prep tool ideal for removing paint, rust, gasket material, grinding welds or brake rotors in confined areas
- Accepts 2" and 3" ROLOC® pads
- Pads attach/release with just a 1/4 turn
- Durable single piece polymer composite housing on prep tool stands up to rugged use, resists most shop chemicals and helps insulate against the cold generated by an air tool
- Oversize trigger for easy operation
- Variable speed trigger
- Bottom handle diffused exhaust
- Built in speed regulator offers easy one hand operation

## 3" Sander, Dual Action , Micro

Packing: 1

AT402MCA

Order NO.: 701057



Pad Size (inches)	Rated Power (kW)	Free Speed RPM	Spindle Thread (inches)
3	0.19	15,000	5/16 -24
Air Consumption, Free Speed (L/MIN)	Air Inlet Thread Size	Recommended Hose Size (inches)	Vibration Level (m/s <sup>2</sup> )
59	1/4" -18 NPT	3/8	<2.5
Sound Level dBa Pressure	Length (mm)	Weight (kg)	
84	133	0.50	

- Use the AT402MCA micro sander to deliver fine swirl free results when sanding, feather edging, scuff sanding, sanding primer surfaces, top coating surface preps, scuffing door and rocker panel jams plus other finesse sanding applications
- Durable single piece polymer composite housing on sander stands up to rugged use, resists most shop chemicals and helps insulate against the cold generated by an air tool
- Oversize trigger for easy operation
- Variable speed trigger
- Bottom handle diffused exhaust
- Built-in speed regulator is easily operated with one hand

## 3" Polisher, Micro

Packing: 1

AT403MCA

Order NO.: 701058



Pad Size (inches)	Rated Power (kW)	Free Speed RPM	Spindle Thread (inches)
3	0.19	6,000	5/16 -24
Air Consumption, Free Speed (L/MIN)	Air Inlet Thread Size	Recommended Hose Size (inches)	Vibration Level (m/s <sup>2</sup> )
62	1/4" -18 NPT	3/8	<2.5
Sound Level dBa Pressure	Length (mm)	Weight (kg)	
86	143	0.60	

- Small size, light weight and a powerful motor make the AT403MCA micro polisher ideal for polishing motorcycles, bumpers, wheels and more
- Durable single piece polymer composite housing on polisher stands up to rugged use, resists most shop chemicals and helps insulate against the cold generated by an air tool
- Oversize, variable speed trigger for easy operation with a gloved hand
- Bottom handle diffused exhaust
- Built in speed regulator offers easy one hand operation

# Power Tools Air Tools

## Surface Prep Kit, Micro, 13 pcs

Packing: 1

AT401MCKA  
Order NO.: 701059

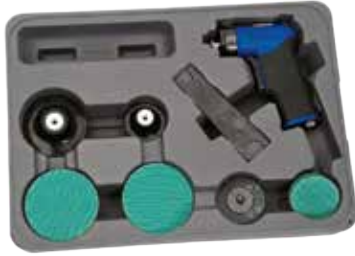

- Includes:  
AT401MCA micro surface prep tool  
(1) 2" ROLOC® pad  
(1) 3" ROLOC® pad  
(5) 2" 40 grit pads  
(5) 3" 80 grit pads in storage case

## 3" Polisher Kit, Micro, 5 pcs

Packing: 1

AT403MCKA  
Order NO.: 701061



- Includes:  
AT403MCA micro polisher  
(1) 3" Hook-It® pad  
(1) 3" wool pad  
(1) 3" foam pad in storage case

## 3" Sander Kit, Micro, Dual Action, 72 pcs

Packing: 1

AT402MCKA  
Order NO.: 701060



- Includes:  
AT402MCA micro sander  
(1) 3" Hook-It® pad  
(25) 3" 180 grit pads  
(25) 3" 200 grit pads  
(10) 3" 320 grit pads  
(10) 3" 800 grit pads in storage case

## Polisher, Heavy Duty, Vertical

Packing: 1

AT460BP  
Order NO.: 701062



Pad Size (inches)	Rated Power (kW)	Free Speed RPM	Spindle Thread (inches)	
7	0.49	4,500	5/8 -11	
Air Consumption, Free Speed (L/MIN)	Air Inlet Thread Size	Recommended Hose Size (inches)	Vibration Level (m/s <sup>2</sup> )	
136	1/4" -18 NPT	3/8	<2.5	
Sound Level dBa Pressure	Length (mm)	Weight (kg)	Standard Pad	Spanner Wrench (opt)
83	185	2.27	AT450-46H	AT450-50

- Removable side handle



# Power Tools Cordless Tools

## 3/8" Impact Wrench

Packing: 1

ETB14438A  
Order NO.: 702001



Square Drive (inches)	Blows per Minute (BPM)	Maximum Torque (N·m)	Free Speed (RPM)	Duration of each full charge	
3/8	2400	189	0-2, 200	More than 300 tightening cycles	
Motor / Battery Voltage (V)	Length (mm)	Weight (kg)	Battery Pack	Battery Charger	Charge Time (min)
14.4	178	1.9	ETB14419A	ETB14401A	45

- Delivers 140 ft. lbs. max torque in a compact design to provide the user maximum versatility
- Includes two batteries and one charger packed in a blow molded case
- Batteries have a 1.9 Ah that provides a long run time
- Easily replaceable carbon brushes to keep your investment running like new
- Slide-on battery provides better contact and safer operation since battery won't drop
- Perfectly balanced compact shape with surrounding soft-grip handle reduces fatigue
- Space included in the molded case to add the ETB14410A LED light

## LED Light

Packing: 1

ETB14410A  
Order NO.: 702003



Length (mm)	Weight (kg)	Battery Pack	Battery Charger	Duration of each full charge
228	0.2	ETB14419A (not included)	ETB14401A (not included)	14 hours continuous

- LED bulb provides long life and low power draw for less job interruptions
- 90 degree pivoting head puts the light ray where you need it
- Faceted reflector provides bright uniform beam
- Perfectly balanced compact shape with surrounding soft-grip handle reduces fatigue
- Slide-on battery provides better contact and safer operation since battery won't drop

## 3/8" Drill, Two Speed

Packing: 1

ETB14420A  
Order NO.: 702002



Chuck Cap (inches)	No Load Speed (RPM)	Maximum Torque (N·m)	Motor/Battery Voltage (V)	Charge Time (min)
3/8	0-400/0-1400	30	14.4	45
Battery Pack	Battery Charger	Length (mm)	Weight (kg)	Duration of each full charge
ETB14419A (1.9Ah)	ETB14401A	216	1.9	More than 30 drilling cycles

- Includes cordless drill, 2 batteries and battery charger
- Keyless chuck provides quick replacement of bits to save time
- Two speed switch and variable speed trigger offers maximum control in both forward and reverse
- Clutch cap provides 20 different settings up to 260 inch pounds torque for precision jobs
- White LED illuminates when trigger is depressed for those dim working conditions
- Slide-on battery provides better contact and safer operation since battery won't drop
- Perfectly balanced compact shape with surrounding soft-grip handle reduces fatigue
- Space included in the molded case to add the ETB14410A light

## 3/8" Drive Cordless Ratchet

Packing: 1

ETB14460A  
Order NO.: 702007



Square Drive (inches)	Maximum Torque (N·m)	Motor / Battery Voltage (V)	Free Speed RPM	Length (mm)
3/8	47	14.4	225	378
Weight with Battery Pack (kg)	Battery Pack	Battery Charger	Vinyl Boot (optional)	
6.6	ETB14419A	ETB14401A	YA889A (Black)	

- Cord free eliminates dragging dirty air hoses in and across the service vehicle
- High Speed (190 RPM) increases productivity
- Delivers 35 ft.lbs. (47 N·m) of torque
- 1.9 Ah Ni-cad battery provides user with ample run time between charges
- Aluminium housing provides durability under manual stress loads

# Power Tools Cordless Tools / Impact Sockets

## 3/8" Drill

Packing: 1

ETB14430A  
Order NO.: 701064



Drilling Capability (mm)	No Load Speed (RPM)	Maximum Torque (N·m)	Voltage (V)	
13	0-1000	23	9.6	
Charge Time (min)	Weight (kg)	Length (mm)	Duration of each full charge	Package
45	1.4	27	More than 30 drilling cycles	2Battery 1Charger 1Key

- This is a professional cordless drill suitable for general purpose drilling for all type of woods and metal, which can be used in automotive repairs, construction and home improvements works

## Battery, 14.4V

Packing: 1

ETB14419A  
Order NO.: 702005



- 14.4V battery pack for Blue-Point ETB series cordless tools
- Slide-on battery provides better contact and safer operation since battery won't drop
- 45 minutes charging time using ETB14401A charger

## Charger, 14.4V/220V

Packing: 1

ETB14401A  
Order NO.: 702006



- 14.4V battery charger for batteries used on Blue-Point ETB series cordless tools
- 45 minutes charging time on ETB14419A battery

## 3/8" Drive, Shallow, 6pt., mm



Stock No.	Size (mm)		Order No.
BLPSMIM387	7	6	703001
BLPSMIM388	8	6	703002
BLPSMIM389	9	6	703003
BLPSMIM3810	10	6	703004
BLPSMIM3811	11	6	703005
BLPSMIM3812	12	6	703006
BLPSMIM3813	13	6	703007
BLPSMIM3814	14	6	703008
BLPSMIM3815	15	6	703009
BLPSMIM3816	16	6	703010
BLPSMIM3817	17	6	703011
BLPSMIM3818	18	6	703012
BLPSMIM3819	19	6	703013

## 3/8" Drive, Deep, 6pt., mm



Stock No.	Size (mm)		Order No.
BLPLSMIM387	7	6	703014
BLPLSMIM388	8	6	703015
BLPLSMIM389	9	6	703016
BLPLSMIM3810	10	6	703017
BLPLSMIM3811	11	6	703018
BLPLSMIM3812	12	6	703019
BLPLSMIM3813	13	6	703020
BLPLSMIM3814	14	6	703021
BLPLSMIM3815	15	6	703022
BLPLSMIM3816	16	6	703023
BLPLSMIM3817	17	6	703024
BLPLSMIM3818	18	6	703025
BLPLSMIM3819	19	6	703026

- Designed for maximum engagement on 6 point fasteners
- Suitable for use with pneumatic and electric impact wrenches
- Specially heat treated for impact use to provide long life, safety, and durability
- Drive end features pin retention hole and groove

# Power Tools Impact Sockets

## 3/8" Drive, Shallow, 6pt., inches



Stock No.	Size (inches)		Order No.
BLPSIM3814	1/4	6	703027
BLPSIM38516	5/16	6	703028
BLPSIM3838	3/8	6	703029
BLPSIM38716	7/16	6	703030
BLPSIM3812	1/2	6	703031
BLPSIM38916	9/16	6	703032
BLPSIM3858	5/8	6	703033
BLPSIM381116	11/16	6	703034
BLPSIM3834	3/4	6	703035

## 3/8" Drive, Deep, 6pt., inches



Stock No.	Size (inches)		Order No.
BLPLSIM3814	1/4	6	703036
BLPLSIM38516	5/16	6	703037
BLPLSIM3838	3/8	6	703038
BLPLSIM38716	7/16	6	703039
BLPLSIM3812	1/2	6	703040
BLPLSIM38916	9/16	6	703041
BLPLSIM3858	5/8	6	703042
BLPLSIM381116	11/16	6	703043
BLPLSIM3834	3/4	6	703044

- Designed for maximum engagement on 6 point fasteners
- Suitable for use with pneumatic and electric impact wrenches
- Specially heat treated for impact use to provide long life, safety, and durability
- Drive end features pin retention hole and groove

## 3/8" Drive, Extra Long, 6pt., inches



Stock No.	Size (inches)		Order No.
BLPSMS8	8	6	704056
BLPSMS10	10	6	704057
BLPSMS12	12	6	704058

- Extra length at 100 mm to reach two-wheelers transmission box screws
- Single piece construction
- For use on impact wrench without the need for extra extension

## 3/8" Drive Adaptor

Packing: 6

BLPAIM1238  
Order NO.: 703049



Stock No.	Size (inches)
BLPAIM1238	1/2 male X 3/8 female

- Specially heat treated for impact use to provide long life, safety, and durability
- Suitable for use with pneumatic and electric impact wrenches
- Drive end features pin retention hole and groove

## 3/8" Drive Universal Joints

Packing: 6

BLPJIM38  
Order NO.: 703046



Stock No.	Size (inches)
BLPJIM38	3/8 male X 3/8 female

- Specially heat treated for impact use to provide long life, safety, and durability
- Suitable for use with pneumatic and electric impact wrenches
- Drive end features pin retention hole and groove

## 3/8" Drive Extension



Stock No.	Size (inches)		Order No.
BLPEXIM383	3	6	703047
BLPEXIM386	6	6	703048

- Specially heat treated for impact use to provide long life, safety, and durability
- Suitable for use with pneumatic and electric impact wrenches
- Drive end features pin retention hole and groove

## 1/4" Drive, Impact Adaptor

Packing: 6

BLPAIM3814  
Order NO.: 703045



Stock No.	Size (inches)
BLPAIM3814	3/8 male X 1/4 female

- Specially heat treated for impact use to provide long life, safety, and durability
- Suitable for use with pneumatic and electric impact wrenches
- Drive end features pin retention hole and groove

# Power Tools Impact Sockets

## 1/2" Drive, Shallow, 6pt., mm



Stock No.	Size (mm)		Order No.
BLPSMIM1210	10	6	703050
BLPSMIM1211	11	6	703051
BLPSMIM1212	12	6	703052
BLPSMIM1213	13	6	703053
BLPSMIM1214	14	6	703054
BLPSMIM1215	15	6	703055
BLPSMIM1216	16	6	703056
BLPSMIM1217	17	6	703057
BLPSMIM1218	18	6	703058
BLPSMIM1219	19	6	703059
BLPSMIM1221	21	6	703060
BLPSMIM1222	22	6	703061
BLPSMIM1223	23	6	703062
BLPSMIM1224	24	6	703063
BLPSMIM1227	27	6	703064
BLPSMIM1229	29	6	703065
BLPSMIM1230	30	6	703066
BLPSMIM1232	32	6	703067

## 1/2" Drive, Shallow, 6pt., inches



Stock No.	Size (inches)		Order No.
BLPSIM1238	3/8	6	703086
BLPSIM12716	7/16	6	703087
BLPSIM1212	1/2	6	703088
BLPSIM12916	9/16	6	703089
BLPSIM1258	5/8	6	703090
BLPSIM121116	11/16	6	703091
BLPSIM1234	3/4	6	703092
BLPSIM121316	13/16	6	703093
BLPSIM1278	7/8	6	703094
BLPSIM121516	15/16	6	703095
BLPSIM121	1	6	703096
BLPSIMB121116	1 1/16	6	703097
BLPSIMB12118	1 1/8	6	703098
BLPSIMB12114	1 1/4	6	703099
BLPSIMB121516	1 5/16	6	703100
BLPSIMB121716	1 7/16	6	703101

## 1/2" Drive, Deep, 6pt., mm



Stock No.	Size (mm)		Order No.
BLPLSMIM1210	10	6	703068
BLPLSMIM1211	11	6	703069
BLPLSMIM1212	12	6	703070
BLPLSMIM1213	13	6	703071
BLPLSMIM1214	14	6	703072
BLPLSMIM1215	15	6	703073
BLPLSMIM1216	16	6	703074
BLPLSMIM1217	17	6	703075
BLPLSMIM1218	18	6	703076
BLPLSMIM1219	19	6	703077
BLPLSMIM1221	21	6	703078
BLPLSMIM1222	22	6	703079
BLPLSMIM1224	24	6	703080
BLPLSMIM1226	26	6	703081
BLPLSMIM1227	27	6	703082
BLPLSMIM1229	29	6	703083
BLPLSMIM1230	30	6	703084
BLPLSMIM1232	32	6	703085

- Designed for maximum engagement on 6 point fasteners
- Suitable for use with pneumatic and electric impact wrenches
- Specially heat treated for impact use to provide long life, safety, and durability
- Drive end features pin retention hole and groove

## 1/2" Drive, Deep, 6pt., inches



Stock No.	Size (inches)		Order No.
BLPLSIM1238	3/8	6	703102
BLPLSIM12716	7/16	6	703103
BLPLSIM1212	1/2	6	703104
BLPLSIM12916	9/16	6	703105
BLPLSIM1258	5/8	6	703106
BLPLSIM121116	11/16	6	703107
BLPLSIM1234	3/4	6	703108
BLPLSIM121316	13/16	6	703109
BLPLSIM1278	7/8	6	703110
BLPLSIM121516	15/16	6	703111
BLPLSIM121	1	6	703112
BLPLSIMB121116	1 1/16	6	703113
BLPLSIMB12118	1 1/8	6	703114
BLPLSIMB121316	1 3/16	6	703115
BLPLSIMB12114	1 1/4	6	703116

- Designed for maximum engagement on 6 point fasteners
- Suitable for use with pneumatic and electric impact wrenches
- Specially heat treated for impact use to provide long life, safety, and durability
- Drive end features pin retention hole and groove

# Power Tools Impact Sockets

## 1/2" Impact Adaptor

Packing: 6

BLPAIM3812  
Order NO.: 703121



Stock No.	Size (inches)
BLPAIM3812	3/8 male X 1/2 female

- Specially heat treated for impact use to provide long life, safety, and durability
- Suitable for use with pneumatic and electric impact wrenches
- Drive end features pin retention hole and groove

## 1/2" Impact Adaptor

Packing: 6

BLPAIM3412  
Order NO.: 703122



Stock No.	Size (inches)
BLPAIM3412	3/4 male X 1/2 female

- Specially heat treated for impact use to provide long life, safety, and durability
- Suitable for use with pneumatic and electric impact wrenches
- Drive end features pin retention hole and groove

## 1/2" Drive Universal Joints

Packing: 6

BLPJIM12  
Order NO.: 703123



Stock No.	Size (inches)
BLPJIM12	1/2 male X 1/2 female

- Specially heat treated for impact use to provide long life, safety, and durability
- Suitable for use with pneumatic and electric impact wrenches
- Drive end features pin retention hole and groove

## 1/2" Drive Extension

Packing: 6

BLPEXIM123  
Order NO.: 703117



Stock No.	Size (inches)		Order No.
BLPEXIM123	3	6	703117
BLPEXIM125	5	6	703118
BLPEXIM126	6	6	703119
BLPEXIM1210	10	6	703120

- Specially heat treated for impact use to provide long life, safety, and durability
- Suitable for use with pneumatic and electric impact wrenches
- Drive end features pin retention hole and groove



# Power Tools Impact Sockets

## 3/4" Drive, Shallow, 6pt., mm



Stock No.	Size (mm)	6	Order No.
BLPSMIM3417	17	6	703124
BLPSMIM3418	18	6	703125
BLPSMIM3419	19	6	703126
BLPSMIM3420	20	6	703127
BLPSMIM3421	21	6	703128
BLPSMIM3422	22	6	703129
BLPSMIM3423	23	6	703130
BLPSMIM3424	24	6	703131
BLPSMIM3425	25	6	703132
BLPSMIM3426	26	6	703133
BLPSMIM3427	27	6	703134
BLPSMIM3428	28	6	703135
BLPSMIM3429	29	6	703136
BLPSMIM3430	30	6	703137
BLPSMIM3431	31	6	703138
BLPSMIM3432	32	6	703139
BLPSMIM3433	33	6	703140
BLPSMIM3434	34	6	703141
BLPSMIM3435	35	6	703142
BLPSMIM3436	36	6	703143
BLPSMIM3437	37	6	703144
BLPSMIM3438	38	6	703145
BLPSMIM3439	39	6	703146
BLPSMIM3440	40	6	703147
BLPSMIM3441	41	6	703148
BLPSMIM3442	42	6	703149
BLPSMIM3443	43	6	703150
BLPSMIM3444	44	6	703151
BLPSMIM3445	45	6	703152
BLPSMIM3446	46	6	703153
BLPSMIM3447	47	6	703154
BLPSMIM3448	48	6	703155
BLPSMIM3449	49	6	703156
BLPSMIM3450	50	6	703157
BLPSMIM3452	52	6	703158
BLPSMIM3454	54	6	703159
BLPSMIM3455	55	6	703160
BLPSMIM3456	56	6	703161
BLPSMIM3457	57	6	703162
BLPSMIM3458	58	6	703163
BLPSMIM3459	59	6	703164
BLPSMIM3460	60	6	703165
BLPSMIM3463	63	6	703166
BLPSMIM3465	65	6	703167

- Designed for maximum engagement on 6 point fasteners
- Suitable for use with pneumatic and electric impact wrenches
- Specially heat treated for impact use to provide long life, safety, and durability
- Drive end features pin retention hole and groove

## 3/4" Drive, Deep, 6pt., mm



Stock No.	Size (mm)	6	Order No.
BLPLSMIM3417	17	6	703169
BLPLSMIM3418	18	6	703170
BLPLSMIM3419	19	6	703171
BLPLSMIM3420	20	6	703172
BLPLSMIM3421	21	6	703173
BLPLSMIM3422	22	6	703174
BLPLSMIM3423	23	6	703175
BLPLSMIM3424	24	6	703176
BLPLSMIM3425	25	6	703177
BLPLSMIM3426	26	6	703178
BLPLSMIM3427	27	6	703179
BLPLSMIM3428	28	6	703180
BLPLSMIM3429	29	6	703181
BLPLSMIM3430	30	6	703182
BLPLSMIM3431	31	6	703183
BLPLSMIM3432	32	6	703184
BLPLSMIM3433	33	6	703185
BLPLSMIM3434	34	6	703186
BLPLSMIM3435	35	6	703187
BLPLSMIM3436	36	6	703188
BLPLSMIM3437	37	6	703189
BLPLSMIM3438	38	6	703190
BLPLSMIM3440	40	6	703191
BLPLSMIM3441	41	6	703192
BLPLSMIM3442	42	6	703193
BLPLSMIM3443	43	6	703194
BLPLSMIM3444	44	6	703195
BLPLSMIM3445	45	6	703196
BLPLSMIM3446	46	6	703197
BLPLSMIM3447	47	6	703198
BLPLSMIM3448	48	6	703199
BLPLSMIM3449	49	6	703200
BLPLSMIM3450	50	6	703201
BLPLSMIM3455	55	6	703202

- Designed for maximum engagement on 6 point fasteners
- Suitable for use with pneumatic and electric impact wrenches
- Specially heat treated for impact use to provide long life, safety, and durability
- Drive end features pin retention hole and groove

# Power Tools Impact Sockets

## 3/4" Drive, Shallow, 6pt., inches



Stock No.	Size (inches)	Packing	Order No.
BLPSIM341116	11/16	6	703203
BLPSIM3434	3/4	6	703204
BLPSIM341316	13/16	6	703205
BLPSIM3478	7/8	6	703206
BLPSIM341516	15/16	6	703207
BLPSIM341	1	6	703208
BLPSIMB341116	1 1/16	6	703209
BLPSIMB34118	1 1/8	6	703210
BLPSIMB341316	1 3/16	6	703211
BLPSIMB34114	1 1/4	6	703212
BLPSIMB341516	1 5/16	6	703213
BLPSIMB34138	1 3/8	6	703214
BLPSIMB341716	1 7/16	6	703215
BLPSIMB34112	1 1/2	6	703216
BLPSIMB341916	1 9/16	6	703217
BLPSIMB34158	1 5/8	6	703218
BLPSIMB341116	1 11/16	6	703219
BLPSIMB34134	1 3/4	6	703220
BLPSIMB3411316	1 13/16	6	703221
BLPSIMB34178	1 7/8	6	703222
BLPSIMB3411516	1 15/16	6	703223
BLPSIMB342	2	6	703224

- Designed for maximum engagement on 6 point fasteners
- Suitable for use with pneumatic and electric impact wrenches
- Specially heat treated for impact use to provide long life, safety, and durability
- Drive end features pin retention hole and groove

## 3/4" Drive Adaptor

Packing: 6

BLPAIM1234  
Order NO.: 703232



Stock No.	Size (inches)
BLPAIM1234	1/2 male X 3/4 female

- Specially heat treated for impact use to provide long life, safety, and durability
- Suitable for use with pneumatic and electric impact wrenches
- Drive end features pin retention hole and groove

## 3/4" Drive Adaptor

Packing: 6

BLPAIM134  
Order NO.: 703316



Stock No.	Size (inches)
BLPAIM134	1 male X 3/4 female

- Specially heat treated for impact use to provide long life, safety, and durability
- Suitable for use with pneumatic and electric impact wrenches
- Drive end features pin retention hole and groove

## 3/4" Drive Universal Joint

Packing: 6

BLPJIM34  
Order NO.: 703233



Stock No.	Size (inches)
BLPJIM34	3/4 male X 3/4 female

- Specially heat treated for impact use to provide long life, safety, and durability
- Suitable for use with pneumatic and electric impact wrenches
- Drive end features pin retention hole and groove

## 3/4" Drive Extension



Stock No.	Size (inches)	Packing	Order No.
BLPEXIM343	3 1/2	6	703225
BLPEXIM344	4	6	703226
BLPEXIM346	6	6	703227
BLPEXIM347	7	6	703228
BLPEXIM348	8	6	703229
BLPEXIM3410	10	6	703230
BLPEXIM3413	13	6	703231

- Specially heat treated for impact use to provide long life, safety, and durability
- Suitable for use with pneumatic and electric impact wrenches
- Drive end features pin retention hole and groove

# Power Tools Impact Sockets

## 1" Drive, Shallow, 6pt., mm



Stock No.	Size (mm)	6pt.	Order No.	Stock No.	Size (mm)	6pt.	Order No.
BLPSMIM117	17	6	703234	BLPSMIM142	42	6	703259
BLPSMIM118	18	6	703235	BLPSMIM143	43	6	703260
BLPSMIM119	19	6	703236	BLPSMIM144	44	6	703261
BLPSMIM120	20	6	703237	BLPSMIM145	45	6	703262
BLPSMIM121	21	6	703238	BLPSMIM146	46	6	703263
BLPSMIM122	22	6	703239	BLPSMIM147	47	6	703264
BLPSMIM123	23	6	703240	BLPSMIM148	48	6	703265
BLPSMIM124	24	6	703241	BLPSMIM149	49	6	703266
BLPSMIM125	25	6	703242	BLPSMIM150	50	6	703267
BLPSMIM126	26	6	703243	BLPSMIM151	51	6	703268
BLPSMIM127	27	6	703244	BLPSMIM152	52	6	703269
BLPSMIM128	28	6	703245	BLPSMIM153	53	6	703270
BLPSMIM129	29	6	703246	BLPSMIM154	54	6	703271
BLPSMIM130	30	6	703247	BLPSMIM155	55	6	703272
BLPSMIM131	31	6	703248	BLPSMIM156	56	6	703273
BLPSMIM132	32	6	703249	BLPSMIM157	57	6	703274
BLPSMIM133	33	6	703250	BLPSMIM158	58	6	703275
BLPSMIM134	34	6	703251	BLPSMIM159	59	6	703276
BLPSMIM135	35	6	703252	BLPSMIM160	60	6	703277
BLPSMIM136	36	6	703253	BLPSMIM163	63	6	703278
BLPSMIM137	37	6	703254	BLPSMIM165	65	6	703279
BLPSMIM138	38	6	703255	BLPSMIM167	67	6	703280
BLPSMIM139	39	6	703256	BLPSMIM168	68	6	703281
BLPSMIM140	40	6	703257	BLPSMIM169	69	6	703282
BLPSMIM141	41	6	703258				

- Designed for maximum engagement on 6 point fasteners
- Suitable for use with pneumatic and electric impact wrenches
- Specially heat treated for impact use to provide long life, safety, and durability
- Drive end features pin retention hole and groove

## 1" Drive, Deep, 6pt., mm



Stock No.	Size (mm)	6pt.	Order No.
BLPLSMIM117	17	6	703283
BLPLSMIM118	18	6	703284
BLPLSMIM119	19	6	703285
BLPLSMIM120	20	6	703286
BLPLSMIM121	21	6	703287
BLPLSMIM122	22	6	703288
BLPLSMIM123	23	6	703289
BLPLSMIM124	24	6	703290
BLPLSMIM125	25	6	703291
BLPLSMIM126	26	6	703292
BLPLSMIM127	27	6	703293
BLPLSMIM128	28	6	703294
BLPLSMIM129	29	6	703295
BLPLSMIM130	30	6	703296
BLPLSMIM131	31	6	703297
BLPLSMIM132	32	6	703298
BLPLSMIM133	33	6	703299
BLPLSMIM134	34	6	703300
BLPLSMIM135	35	6	703301
BLPLSMIM136	36	6	703302
BLPLSMIM137	37	6	703303
BLPLSMIM138	38	6	703304
BLPLSMIM140	40	6	703305
BLPLSMIM141	41	6	703306
BLPLSMIM142	42	6	703307
BLPLSMIM143	43	6	703308
BLPLSMIM146	46	6	703309
BLPLSMIM149	49	6	703310
BLPLSMIM150	50	6	703311
BLPLSMIM155	55	6	703312

- Designed for maximum engagement on 6 point fasteners
- Suitable for use with pneumatic and electric impact wrenches
- Specially heat treated for impact use to provide long life, safety, and durability
- Drive end features pin retention hole and groove



# Power Tools Impact Sockets

## 1" Drive Adaptor

Packing: 6

BLPAIM341  
Order NO.: 703317



Stock No.	Size (inches)
BLPAIM341	3/4 male X 1 female

- Specially heat treated for impact use to provide long life, safety, and durability
- Suitable for use with pneumatic and electric impact wrenches
- Drive end features pin retention hole and groove

## 1" Drive Adaptor

Packing: 6

BLPAIM1121  
Order NO.: 703318



Stock No.	Size (inches)
BLPAIM1121	1 1/2 male X 1 female

- Specially heat treated for impact use to provide long life, safety, and durability
- Suitable for use with pneumatic and electric impact wrenches
- Drive end features pin retention hole and groove

## 1" Drive, Universal Joint

Packing: 6

BLPJIM1  
Order NO.: 703315



Stock No.	Size (inches)
BLPJIM1	7

- Specially heat treated for impact use to provide long life, safety, and durability
- Suitable for use with pneumatic and electric impact wrenches
- Drive end features pin retention hole and groove

## 1" Drive Extension



Stock No.	Size (inches)		Order No.
BLPEXIM17	7	6	703313
BLPEXIM113	13	6	703314

- Specially heat treated for impact use to provide long life, safety, and durability
- Suitable for use with pneumatic and electric impact wrenches
- Drive end features pin retention hole and groove



# Power Tools Accessories

## Regulator, Combination Air Line

Packing: 1



AHRB200

Order NO.: 704001

Inlet/Outlet Port Size	1/2" NPT (F)
Adjustable Pressure Range	5-120 PSIG (.5-8.5 kgf/cm <sup>2</sup> )
Maximum Service Pressure	140 PSIG (9.9 kgf/cm <sup>2</sup> )
Oil Capacity	80 ml
Operating Temperature Range Pressure	41-140° F (5-60° C)

## Step Drill Set, 3 pcs

Packing: 1



YAS203A

Order NO.: 704005

Stock No.	Hole Sizes Per Bit	Increments (inches)	Length (inches)	Shank Size (inches)	Size Range (inches)	Order No.
YA261A	13	1/32	3 1/4	1/4	1/8 - 1/2	704002
YA262A	6	1/16	3 3/8	1/4	3/16 - 1/2	704003
YA263A	9	1/16	2 5/8	3/8	1/4 - 3/4	704004

- Includes YA261A, YA262A and YA263A (3 pcs)

## Grinding Wheels Set

Packing: 1



ETA125A

Order NO.: 704006

- Use with ET1350/ET1360
- Maximum rating of 12,000 RPM

## Grinding Wheel

Packing: 1



AT415T27MP

Order NO.: 704022

- Use for rough grinding applications
- Use on 4 1/2" grinders with 5/8" x 11 thread arbor
- Re-order in multi-packs

## Cut Off Wheel

Packing: 1



AT415CWMP

Order NO.: 704021

- Use for metal notching and bolt cutting
- Use on 4 1/2" grinders with 5/8" x 11 thread arbor
- Re-order in multi-packs

## Flap Discs



Stock No.	Diameter (inches)	Type	Grit	Quantity to Pack	Packing	Order No.
AC2Z40T27MP	2	27	40	10	1	704013
AC2Z60T27MP	2	27	60	10	1	704014
AC2Z80T27MP	2	27	80	10	1	704015
AC4Z60T27MP	4	27	60	10	1	704019

# Power Tools Accessories

## Flap Wheels



Stock No.	Diameter (inches)	Type	Grit	Quantity to Pack		Order No.
AC3160FWMP	3	—	60	10	1	704017
AC3180FWMP	3	—	80	10	1	704018
AC31120FWMP	3	—	120	10	1	704016

- Applications include cleaning, edge blending and smoothing metal, plastic or wood
- 3" aluminum oxide flap wheel is designed to provide fast cutting action
- 1/4" stem on solid hub permits a higher RPM rating and increased productivity
- Use on electric and pneumatic drills

## Wire Wheel

Packing: 1



AC616  
Order NO.: 704020

- 3" crimped wire wheel is a great general purpose cleaner
- Features individual crimped filaments that support each other while being flexible
- General applications include deburring, weld cleaning and rust and paint removal
- Use on electric and pneumatic drills
- .0118 CWS-1/4

## Wire Brush



Stock No.	Brush Dia. (inches)	Shank Size Arbor Size (inches)	Wire Diameter (inches)	Maximum Rated RPM		Order No.
AC17D	1	1/4	.006	20,000	1	704011
AC243	3	5/8 - 11	.014	14,000	1	704012

- Features individual crimped filaments that support each other while being flexible
- Use for medium duty general purpose cleaning

## Wire Brush



Stock No.	Brush Dia. (inches)	Maximum Safe Free Speed (RPM)	Shank Size Arbor Size	Wire Diameter (inches)		Order No.
AC420A	4	20,000	5/8" X 11	0.020	1	704007
AC421A	4	20,000	M10 x1.25	0.020	1	704008

- Knotted wire wheel
- Use for heavy duty cleaning
- Ideal for pre-welding prep and weld cleaning

## End Brush



Stock No.	Brush Dia. (inches)	Shank Size Arbor Size (inches)	Wire Diameter (inches)	Maximum Rated RPM		Order No.
AC10302	1/2	1/4	.014	25,000	1	704009
AC10306	3/4	1/4	.014	22,000	1	704010

- Features individual crimped filaments that support each other while being flexible
- Ideal for cleaning right angles

## Wool Buffering Pad

Packing: 1



POLISHW8A  
Order NO.: 704023

- Ideal for cutting, buffing, and removal of scratches and paint imperfections
- 1 1/2" wool pile last longer than standard wool pads
- Washable for easy clean up
- Use for base and clear coats, acrylic, enamel, lacquer, urethane, fiberglass, plastics and other applications
- Can be used with AT450CP, AT460BP and ETB1580B Polishers



# Power Tools Accessories

## Blow Gun

Packing: 1



JT13B

Order NO.: 704024

- Tapered, rubber tip for a leak proof connection between gun and fluid line
- Won't mar surfaces
- Vinyl coated control lever
- Hanging hook for storage
- 4 1/2" long

## Blow Gun

Packing: 1



YA1050B

Order NO.: 704025

- Pistol grip style with front full size trigger
- Infinitely variable flow
- 10 1/4" long



## Air Hoses

Packing: 1



AIRHOSE35

Order NO.: 704026

- Extremely lightweight for easy maneuverability
- Reinforced construction eliminates layer separation resulting from expansion and contraction during pulsating operations
- More abrasion resistant than PVC and rubber hoses
- Easy to wrap and store even in subzero weather
- UV stabilized for longer outdoor life
- Strain relief features an tight bending radius to virtually eliminate hose kinking
- Reusable fittings and strain reliefs for longer life

## Cobalt Drill Bit Set , 21 pcs

Packing: 1



DBBPC21

Order NO.: 704053

- DBBPC1/16 thru DBBPC3/8 (21 pcs) (1/16" to 3/8") in metal drill bit index

## HSS Drill Bit Set , 21 pcs

Packing: 1



DBBP21

Order NO.: 704054

- DBBP1/16 thru DBBP3/8 (21 pcs) (1/16" to 3/8") in metal drill bit index

## Titanium Coated Drill Bit Set, 13 pcs

Packing: 1



DBBPT13

Order NO.: 704055

- DBBPT1/16 thru DBBPT1/4 (13 pcs) (1/16" to 1/4") in metal drill bit index

## Air Line Couplers and Adaptors

Packing: 1



AHC21PD

Order NO.: 704033

Stock No.	Body Size (inches)	Style	Thread Size
AHC21PD	1/4	Rigid Mounting	1/4" -18 NPT

# Power Tools Accessories

## Air Line Couplers and Adaptors



Stock No.	Body Size (inches)	Style	Thread Size	Quick Coupler Male	Order No.
AHC21PMD	1/4	Industrial Interchange	1/4" -18 NPT	AHC21PMC	704036
AHC21D	1/4	Industrial Interchange	1/4" -18 NPT	AHC21PMC	704052
AHC21MD	1/4	Industrial Interchange	1/4" -18 NPT	AHC21PMC	704041
AHC21FD	1/4	Industrial Interchange	1/4" -18 NPT	AHC21PMC	704032



Stock No.	Body Size (inches)	Style	Thread Size	Order No.
AHC22E	3/8	Industrial Interchange	1/4" -18 NPT	704028
AHC22MD	3/8	Industrial Interchange	1/4" -18 NPT	704030
AHC22FD	3/8	Industrial Interchange	1/4" -18 NPT	704046



Stock No.	Body Size (inches)	Style	Thread Size	Quick Coupler Male	Order No.
AHC23PMD	1/4	ARO	1/4" -18 NPT	AHC23PMC	704039
AHC23D	1/4	ARO	1/4" -18 NPT	AHC23PMC	704037
AHC23MD	1/4	ARO	1/4" -18 NPT	AHC23PMC	704051
AHC23FD	1/4	ARO	1/4" -18 NPT	AHC23PMC	704047



Stock No.	Body Size (inches)	Style	Thread Size	Order No.
AHC24D	1/4	True-Flate	1/4" -18 NPT	704048
AHC24MD	1/4	True-Flate	1/4" -18 NPT	704049
AHC24FD	1/4	True-Flate	1/4" -18 NPT	704050

## Air Line Couplers and Adaptors



Stock No.	Body Size (inches)	Style	Thread Size	Order No.
AHC25D	3/8	True-Flate	1/4" -18 NPT	704031
AHC25MD	3/8	True-Flate	1/4" -18 NPT	704043
AHC25FC	3/8	True-Flate	1/4" -18 NPT	704040



Stock No.	Body Size (inches)	Style	Thread Size	Order No.
AHC26D	1/4	Lincoln	1/4" -18 NPT	704027
AHC26MD	1/4	Lincoln	1/4" -18 NPT	704029
AHC26FD	1/4	Lincoln	1/4" -18 NPT	704038



Stock No.	Body Size (inches)	Style	Thread Size	Order No.
AHC27D	1/2	Industrial Interchange	1/2" -14 NPT	704045
AHC27FD	1/2	Industrial Interchange	1/2" -14 NPT	704042



Stock No.	Body Size (inches)	Style	Thread Size	Order No.
AHC28D	3/8	Industrial Interchange	3/8" -18 NPT	704035
AHC28MD	3/8	Industrial Interchange	3/8" -18 NPT	704044
AHC28FD	3/8	Industrial Interchange	3/8" -18 NPT	704034





# Striking & Cutting

When it comes to striking tools, Blue-Point's lineage stretches back to 1940 when the company first produced punches and chisels that managed to penetrate and cut through quarter-inch steel. That was a remarkable achievement then.

The range today includes other selection of tools for various striking and cutting applications, bearing the same trademark hardness and toughness. Our wide range of superior hammers and cutting tools set us apart from the competition.





Hammers

108

Punches &  
Chisels

110

Cutting Tools

111

# Striking & Cutting Hammers

## Ball Peen - Wood Handle



### Ball Peen, Wood Handle



### Ball Peen, Fiberglass Handle



### Cross Peen, Hickory Handle



Stock No.	Weight (oz.)		Order No.
BPB4	4	1	801013
BPB8	8	1	801014
BPB12	12	1	801015
BPB16	16	1	801016
BPB24	24	1	801017
BPB32	32	1	801018
BPB40	40	1	801019
BPB48	48	1	801020

Stock No.	Weight (oz.)	Handle Length (inches)	Replacement Handle		Order No.
BPB8B	8	11	BPBH8B	1	801001
BPB12B	12	12	BPBH12B	1	801002
BPB16B	16	13	BPBH12B	1	801003
BPB24B	24	14	BPBH24B	1	801004
BPB32B	32	16	BPBH24B	1	801005

Stock No.	Weight (oz.)	Head Length (inches)	Overall Length (inches)	Replacement Handle		Order No.
BH141A	32	4 1/2	15	BPH20C	1	801006
BH142A	40	5	15	BPH40C	1	801007



# Striking & Cutting Hammers

## Soft Face

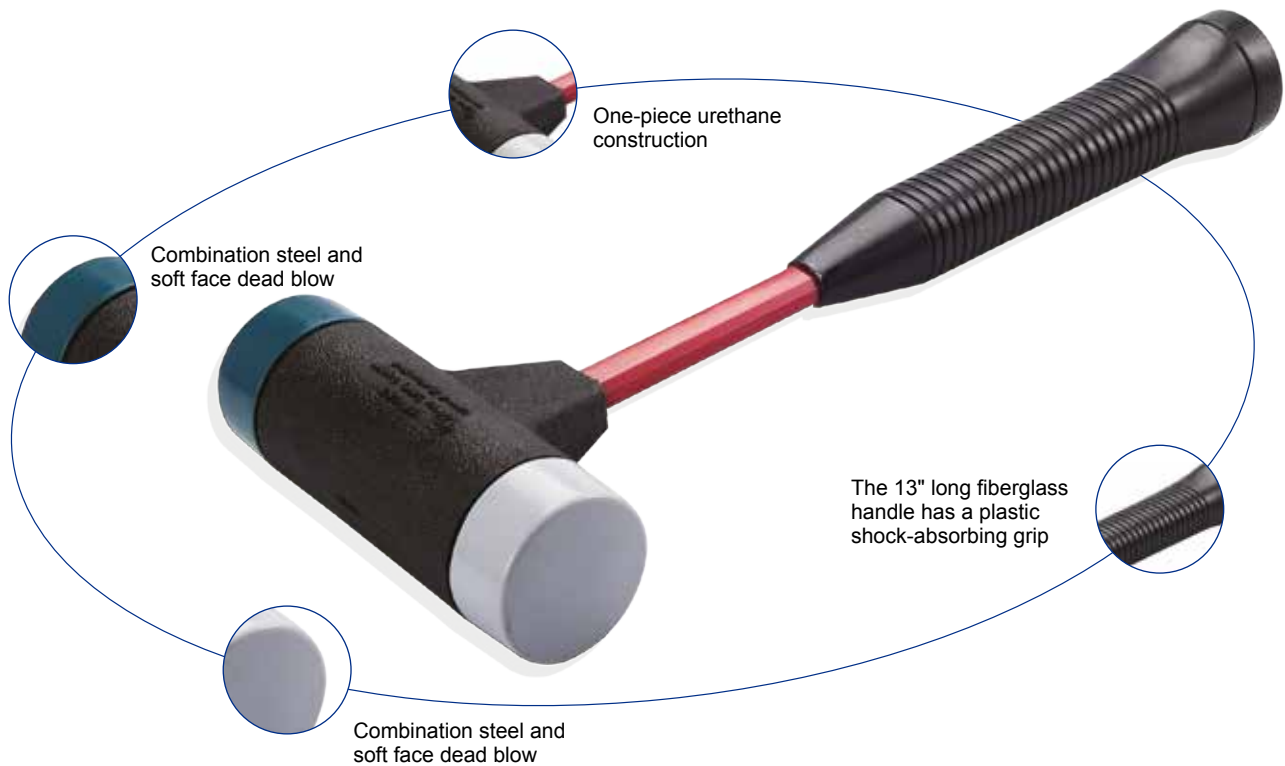

### Soft Face

Packing: 1

BH232A

Order NO.: 801008

### Rubber Head Mallet

Packing: 1

BF620C

Order NO.: 801010

### Soft Blow

Packing: 1

BF623

Order NO.: 801009



Stock No.	Weight (oz.)	Length (inches)
BH232A	32	13

- Combination steel and soft face dead blow
- One-piece urethane construction
- The 13" long fiberglass handle has a plastic shock-absorbing grip
- Tip diameter is 1 5/8"
- Includes two replaceable tips: soft (BH232-2) and hard (BH232-3)
- Optional nylon tip (BH232-4)

Stock No.	Length (inches)	Face Dimensions (inches)
BF620C	13 1/4	3 3/4 x 2 1/4

- Solid rubber head
- 11" Hardwood handle
- Ideal for replacing hubcaps, bodywork, etc

Stock No.	Length (inches)	Face Dimensions (inches)	Head Color
BF623	12 1/2	1 7/8 x 2 1/8	Blue

- Use on all types of surfaces and assemblies including metal, glass, plastic and wood
- Conforms to irregular surfaces
- Designed for maximum surface contact
- Low rebound
- Dissipates hand jarring shock
- Resists most chemicals
- Wood handle
- Reduces denting and marring

# Striking & Cutting Hammers / Punches and Chisels

## Brass Hammer



Stock No.	Weight (lbs.)	Length (inches)		Order No.
HBR15	1 1/2	12	1	801011
HBR25	2 1/2	12	1	801012

- Non-sparking/non-marring surface for many applications
- Brass head absorbs blow and reduces rebound
- Flat surface for even distribution of blow
- Fiberglass handle for strength
- Comfortable, non-slip handle grip

## Fiberglass Hammer



Stock No.	Description	Weight, lbs	Striking Face Dia. (inches)	Handle Length (inches)	Overall Length (inches)	Replacement Handle		Order No.
BC4SG	Cross Peen	4	1 1/2	12	14	BD4SG-1	1	801021
BD4SG	Engineer	4	1 1/2	12	14	BD4SG-1	1	801022
HD4SG	Hand Drilling	4	1 1/2	8 3/4	10 3/4	HD4SG-1	1	801023

- Fiberglass handle dampens vibration and provides extra strength and safety
- Handle is epoxy-welded to hammer head and will withstand 8,000 lbs. of separation force
- Handle is resistant to dry rot, warp and splintering
- Comfortable, non-slip handle grip
- Materials will resist most shop chemicals

## Punch Set

Packing: 1

DPFT528B

Order NO.: 802001



- For transferring hole patterns
- Set includes punches from 3/32" to 1/2" in 1/64" increments plus 17/32"
- Each punch is marked with its size and manufactured from tempered steel to promote long tool life
- A metal index provides convenient storage
- Punches are 4 7/8" in length

## Automatic Center Punch

Packing: 1

YA879A

Order NO.: 802002



- Single handed operation
- Design eliminates need for striking with hammer
- Adjustable spring tension cap
- Hardened steel point is replaceable
- 1/2" diameter
- 5" long

## Automatic Center Punch

Packing: 1

YA900

Order NO.: 802003



- Strikes blow when pressure is applied-no hammer needed
- Cap adjusts force of blow
- 7/16" diameter
- 4 3/4" long

# Striking & Cutting Cutting Tools

## Scraper Set

Packing: 1

PKB500A

Order NO.: 802004



Stock No.	Handle Length (Inches)	Blade Length (Inches)	Blade Width (Inches)	Blade Style	Edge		Order No.
PKB50A	4 <sup>7</sup> / <sub>8</sub>	3 <sup>1</sup> / <sub>2</sub>	2	Stiff	Straight	1	802005
PKB52A	4 <sup>7</sup> / <sub>8</sub>	3 <sup>19</sup> / <sub>32</sub>	1 <sup>1</sup> / <sub>4</sub>	Stiff	Straight	1	802006
PKB53A	4 <sup>7</sup> / <sub>8</sub>	3 <sup>19</sup> / <sub>32</sub>	1 <sup>1</sup> / <sub>4</sub>	Stiff	Single Bevel	1	802007

- Set includes PKB50A, PKB52A and PKB53A Putty Knives Scrapers
- Spring tempered, solid brass blades are non-marring, non-sparking, non-magnetic and non-corrosive
- Soft molded rubber handles maximize hand grip, are easy to clean and are resistant to most solvents
- Broad hilt design helps protect against hand slipping when scraping
- Stiff blade style

## Scraper set

Packing: 1

USS103

Order NO.: 802012



Stock No.	Blade Style	Blade Length (Inches)	Length (Inches)		Order No.
US710	Spoon	3 <sup>1</sup> / <sub>2</sub>	8	1	802013
US711	Chisel Tip	2 <sup>1</sup> / <sub>2</sub>	7 <sup>1</sup> / <sub>8</sub>	1	802014
US712	Oyster	2 <sup>1</sup> / <sub>8</sub>	6 <sup>3</sup> / <sub>4</sub>	1	802015

- Set includes US710, US711 and US712 Knife Blade Scrapers
- Remove gaskets, sealers and other caked on materials
- Blade edge designed to work effectively in both push and pull directions
- Stainless steel blades for durability
- Polished blades clean up easily
- Comfortable composite handles feature a contour thumb stop for maximum control and a wide hilt for control

## Scraper Set

Packing: 1

PK500A

Order NO.: 802008



Stock No.	Blade Length (Inches)	Blade Width (Inches)	Blade Style	Edge		Order No.
PK50A	3 <sup>1</sup> / <sub>2</sub>	2	Flexible	Straight	1	802009
PK52A	5 <sup>19</sup> / <sub>32</sub>	1 <sup>1</sup> / <sub>4</sub>	Flexible	Straight	1	802010
PK53A	2 <sup>19</sup> / <sub>32</sub>	1 <sup>1</sup> / <sub>4</sub>	Stiff Chisel	Single Bevel	1	802011

- Set includes PK50A, PK52A and PK53A Putty Knives Scrapers
- Features full length steel blades for strength and durability
- Soft molded rubber handles maximize hand grip and are resistant to most solvents
- Broad hilt design helps protect against hand slipping when scraping

## Walnut Handle Scraper



Stock No.	Blade Length (Inches)	Blade Width (Inches)	Blade Style	Edge	Length (Inches)		Order No.
PKWLR53A	5 <sup>1</sup> / <sub>2</sub>	1 <sup>1</sup> / <sub>4</sub>	Straight	Chisel	9 <sup>1</sup> / <sub>2</sub>	1	802018
PKWSS53A	2 <sup>3</sup> / <sub>4</sub>	1 <sup>1</sup> / <sub>4</sub>	Straight	Chisel	6 <sup>3</sup> / <sub>4</sub>	1	802019

- Quality crafted for hard scraping applications
- Walnut wood handle for comfort
- Full length heavy duty blades for strength
- Large steel cap for striking capability
- Remove gaskets, sealants and body weld breakaway

## Wood Handle Scraper



Stock No.	Handle Material	Handle Length (Inches)	Blade Width (Inches)	Blade Style	Edge		Order No.
PK23A	Maple	3 <sup>7</sup> / <sub>8</sub>	1 <sup>1</sup> / <sub>4</sub>	Heavy Chisel	Single Bevel	1	802020

- Mirror finished hardened steel blade extends through hardwood handle, solidly riveted for durability
- Redwood handle has metal bolster where handle meets blade

# Striking & Cutting Cutting Tools

## Aviation Snips (Discontinued)



Stock No.	Description	Length (inches)		Order No.
DAR9A	Green handled; Right hand cut	9 1/2	1	803010
DAL9A	Red handled; Left hand cut	9 1/2	1	803011

- Offset blades allow cut material to flow beneath your hand without curling
- Maneuverable for angle cutting or pattern configurations
- Cuts up to 18 ga. mild steel
- 1 1/8" cutting edge

## Tin Snips



Stock No.	Description	Blades Length (inches)	Length (inches)		Order No.
CD7A	Duckbill Snips	1 1/2	7	1	803005
CD10A	Duckbill Snips	2 1/4	10	1	803006
CD12A	Combination Snips	3	12	1	803007
CD16A	Bulldog Snips	2 1/2	16	1	803008

- Cut straight, circular, or irregular patterns; right or left cuts

## Metal Cutting Shears (Discontinued)

Packing: 1

DAS30  
Order NO.: 803004



Stock No.	Description	Length (inches)		Order No.
DAL10B	Red handled; Left hand cut	10 1/4	1	803001
DAR10B	Green handled; Right hand cut	10 1/4	1	803002
DAS10B	Yellow handled; Straight cut	10 1/4	1	803003

- Serrated cutting blades
- Narrow bodies allow metal to pass over shears
- Oil and grease resistant grips
- DAS30 Set includes DAL10B, DAR10B and DAS10B

## Shears, Angled, Heavy Duty

Packing: 1

SNP2A  
Order NO.: 803009



- For leather, cloth, plastic, rubber sheet, rubber hose, cardboard, gasket material, rope and many other materials
- Stainless steel blades and fasteners ensure durability
- Precision ground and heat treated for a long lasting edge
- Ergonomic handles can be used right or left handed
- Top of blade is notched for hard wire and twine
- Locking switch ensures safety during storage
- Control switch allows blades to be held in a tighter position for easier handling
- Angled shears allow easier cutting through flat materials
- Soft mold grip for comfort and control

## Vinyl Cutter



Stock No.	Description		Order No.
YA444B	Cutter, Vinyl	1	803013
YA444B1	Replacement Blades	1	803014

- Cleanly cuts plastic, rubber, vinyl, upholstery, leather, hoses, and rope
- ERGO Grip handle with safety lock
- Blade storage in handle
- Includes three (YA444B1) stainless steel replacement blades
- **YA444B1 Replacement Blades**
- Includes 3 replacement blades and anvil for YA444B

# Striking & Cutting Cutting Tools

## Scissors, Shop, Heavy Duty

Packing: 1

HDSCISSORS  
Order NO.: 803012



- For leather, cloth, plastic, rubber sheet, rubber hose, cardboard, gasket material, rope and many other materials
- Stainless steel blade and fasteners
- Precision ground and heat treated for a long lasting edge
- Ergonomic handles can be used right or left handed

## Cutter, Multi-Purpose



Stock No.	Description		Order No.
YA580A	Cutter, Multi-purpose	1	803015
YA580A-1	Replacement Blades	1	803020

- Features auto locking, fully retractable blade
- All metal body is black with pocket clip
- Includes (1) premium steel 13 pt. snap blade
- Overall length of 5 3/8" (136.5mm)
- **YA580A-1 Replacement Blades**
- Pack of 5

## Cutter, Multi-Purpose



Stock No.	Description		Order No.
YA581A	Cutter, Multi-purpose	1	803016
YA581A-1	Replacement Blades	1	803023

- Has three blades with eight snap off points.
- Minimum blade wobble
- Fully retractable
- **YA581A-1 Replacement Blades**
- Pack of 10

## Utility Knife

Packing: 1

LBUK1  
Order NO.: 803017



- Convenience and good looks of a folding lock back knife with easily replaceable two notch razor blades
- Folding lock back blade, hardwood handle with belt clip and thumb stud for one-hand opening
- Includes utility knife and leather pouch (both with Blue-Point® logo) plus 10 replacement blades
- Uses UKBU10 (10 pack) or UKBU50PK (50 pack) replacement blades

## Utility Knife (Discontinued)

Packing: 1

LBUK2  
Order NO.: 803018



- Thumb pad allows controlled application of pressure
- Blades are easily replaced with a flip of a switch
- Blade storage under spring loaded door
- Includes leather pouch with belt loop plus 5 replacement blades

## Utility Knife (Discontinued)

Packing: 1

LBUK3  
Order NO.: 803019



- Solidly constructed lock back utility knife sports polished, stainless steel handle with TPR grips for durability and control
- Two notch blades are easily changed with quick change switch
- Includes belt pouch and 10 titanium replacement blades
- Uses UKBU10 (10 pack) or UKBU50PK (50 pack) replacement blades



# Striking & Cutting Cutting Tools

## Utility Knife Blades

Packing: 1

UKBU10

Order NO.: 803021



- High performance blades are perfect for thick, dense materials
- Bi-metal construction allows blade to bend/flex without breaking under normal work conditions
- Bi-metal lasts up to 3 times longer than normal utility knife blades
- Two-notch blade design fits most standard utility knives
- Use with LBUK1, LBUK2 and LBUK3 Utility Knives
- Pack of 10 blades

## Utility Knife Blades

Packing: 1

UKBU50PK

Order NO.: 803022



- High performance blades are perfect for thick, dense materials
- Bi-metal construction allows blade to bend/flex without breaking under normal work conditions
- Bi-metal lasts up to 3 times longer than normal utility knife blades
- Two-notch blade design fits most standard utility knives
- Convenient dispenser provides storage for used blades
- Use with LBUK1, LBUK2 and LBUK3 Utility Knives
- Dispenser of 50 blades

## Double Flaring Tool Set



Stock No.		Order No.
TF5A	1	803038
TFM5A	1	803039

### TF5A

- Makes double or single flares on soft steel, brass, or aluminum tubing from 3/16" to 1/2" OD
- Makes a smooth fitting, crack free 45° flare
- Set includes five adaptors, yoke assembly, bar assembly, and handle
- Storage case included

### TFM5A Metric Double Flaring Tool Set

- Same design as TF5A except it is for tubing with an OD from 4.75 to 10mm
- Set includes yoke, bar assembly, handle, and five adaptors: 4.75, 5, 6, 8, and 10mm
- Storage case included

## Flaring and Swaging Set

Packing: 1

TF275A

Order NO.: 803040



- 45° flare or swage soft copper, brass, or aluminum tubing
- Die blocks handle 1/8", 3/16", 1/4", 5/16", 3/8", 7/16", 1/2", 5/8", and 3/4" OD tubing
- Swages 3/16", 1/4", 5/16", 3/8", 1/2", 5/8", and 3/4" OD tubing
- TF275PB storage case included

# Striking & Cutting Cutting Tools

## Metric Bubble Flaring Set

Packing: 1

TFM428

Order NO.: 803041



- For automotive brake systems
- Designed for crack free bubble flares on soft wall tubing up to a wall thickness of .028"
- Adaptors included for 4.75, 6, 8, and 10mm flares
- TFM428PB storage case included

## Tube Cutting and Double Flaring Set

Packing: 1

TF528D

Order NO.: 803037



- Contains TC28C tubing cutter and a double flaring set with a flaring bar, rod handle, yoke, and 5 adaptors: 3/16", 1/4", 5/16", 3/8", and 1/2"
- Storage case included

## Tubing Cutter



Stock No.		Order No.
TC28C	1	803030
TC28B1	1	803032

- Cuts soft metal tubing ranging from 1/8" to 1" in diameter
- OD capacity is 1/8" to 1 1/8"
- Micrometer type adjustment
- Retractable locking reamer blade
- Cutter wheel is easily replaceable
- **TC28B1 Cutting Wheel**
- Extra cutter wheel for TC28C

## Tubing Cutter



Stock No.		Order No.
TC123C	1	803031
TC123CRH	1	803035
TC123C1	1	803033

- Handles tubing from 1/8" to 5/8" OD
- Can be used where clearance around tubing is less than 1 3/8"
- 1 1/2" long when closed and 2" long when open; feed knob is 7/8" in diameter
- **TC123CRH Ratcheting Tube Cutter Handle**  
Handle for TC123C tube cutter
- **TC123C1 Cutting Wheel**  
Extra cutter wheel for TC123C

## Ratcheting Tube Cutter

Packing: 1

TC123CR  
Order NO.: 803034



- TC123C cutter and TC123CRH handle combined into one unit





# Measuring & Other Hand Tools







You will find a good selection of measuring equipment with high accuracy and other hand tools that is of good quality in this section. We strive to offer a good balance of quality to the price in these products. And there are also a number of innovative items, like the magnetic-based flashlight, created with user friendliness in mind.



Measuring  
Tools

118

Flashlights

122

Safety

124

Miscellaneous

126

# Measuring & Other Hand Tools Measuring Tools

## Feeler Gauges, 13pcs

Packing: 1

FB310B

Order NO.: 804001



## Feeler Gauges, 25pcs

Packing: 1

FB325A

Order NO.: 804002



## Feeler Gauges, 35pcs

Packing: 1

FB335

Order NO.: 804003



Stock No.	Increments	Blade Size	Style	Blade Dimensions (inches)	No. of Blades	Description
FB310B	-	.001", .0015", .002" thru .008", .010", .012", .013", .015"	General Use	1/2 x 3	13	Double stamped with U.S. and metric sizes
FB325A	.001"	.0015", .002" thru .025"	General Use	1/2 x 3	25	Double stamped with U.S. and metric sizes
FB335	.001"	.0015", .002" thru .035"	General Use	1/2 x 3	35	Swedish feeler blade steel

## Feeler Gauges, 25pcs

Packing: 1

FBL325A

Order NO.: 804004



## Feeler Gauges, 20pcs

Packing: 1

FBM320

Order NO.: 804005



## Feeler Gauges, 18pcs

Packing: 1

FB316B

Order NO.: 804006



Stock No.	Increments	Blade Size	Style	Blade Dimensions (inches)	No. of Blades	Description
FBL325A	.001"	.0015", .002" thru .021", .025", .027", .030", .040"	Long Blade General Use	1/2 x 12	25	Long blade, double stamped with U.S. and metric sizes
FBM320	.05mm	.05 thru 1mm	Metric General Use	1/2 x 3	20	Metric Feeler Gauge Set
FB316B	.001"	.010", .012", .013", .015" thru .022", .024" thru .026", .028", .030", .032", .035"	Short Blade Ignition/Spark Plug Gauge	1/4 x 1 3/4	18	Short Blade, Ignition/Spark Plug Gauge Set

## Feeler Gauges, 26pcs

Packing: 1

FB326B

Order NO.: 804007



## Feeler Gauges, 25pcs

Packing: 1

FB300A

Order NO.: 804008



## Feeler Gauges, 12pcs

Packing: 1

FB308D

Order NO.: 804009



Stock No.	Increments	Blade Size	Style	Blade Dimensions (inches)	No. of Blades	Description
FB326B	.001"	.008", .010", .012", .013", .015", .017", .018", .020", .022", .024" thru .026", .028", .030", .032", .035"	Combination Feeler/Ignition Gauge	1/2 x 3	26	Double stamped with U.S. and metric sizes
FB300A	.001"	.006" thru .030"	Bent Blade	1/2 x 3	25	Feeler Gauge Set
FB308D	.001"	.008"- .010", .011"- .013", .013"- .015", .014"- .016", .015"- .017", .017"- .019", .018"- .020", .020"- .022", .023"- .025", .025"- .027", .026"- .028", .028"- .030"	Step Blade	1/2 x 3	12	Step Feeler Gauge Set, Bent handle to clear manifolds, double stamped with U.S./Metric sizes. Blades are mounted on FB17 holder

# Measuring & Other Hand Tools Measuring Tools

## Feeler Gauges, 22pcs

Packing: 1

FB322  
Order N804010



## Feeler Gauges, 2pcs

Packing: 1

FB328A  
Order NO.: 804011



## Feeler Gauges, 2pcs

Packing: 1

FBM322  
Order NO.: 804012



Stock No.	Increments	Blade Dimensions (inches)	Blade Size	No. of Blades	Description
FB322	.001"	1/2 x 3 3/8	.004"-.006" thru .025"-.027"	22	"Go-No Go" blades with 2 sizes each
FB328A	—	1/2 x 3	.011"-.013", .013"-.015"	2	For valve adjustment on GM 8.2L engines, double stamped with U.S. and metric sizes
FBM322	—	1/2 x 3	.20-.30mm, .40-.50mm	2	10 3/4 long bent handle

## Feeler Gauges, 14pcs

Packing: 1

FB307D  
Order NO.: 804013



Increments	Blade Dimensions (inches)	Blade Size	No. of Blades
.001"	1/2 x 4 1/2	.008", .011" thru .014", .016" thru .018", .020", .023" thru .025", .027", .029"	14

- Bent blade cummins diesel, blade ends are bent at 90° angle: blades are secured on FB307C1 ring

## Long Tape, Steel, 100ft

Packing: 1

TPM100  
Order NO.: 804014



- Includes inch/metric scale
- Quick rewind design for ease of use
- Rewinding lever conveniently stored in housing
- Non-slip grip provides confidence and comfort

## Measuring Tapes



Stock No.	Length (meter)	Packing	Order No.
BMPML3	3	1	804018
BMPML5	5	1	804019

- Rubberized coating for better grip
- Tape auto-lock when extended
- Nylon coated tape

## Spirit Levels, 9"

Packing: 1

TL100A  
Order NO.: 804021



- 9" precision measuring tool designed for close quarter work
- Magnetic strips and v-grooving make it ideal for pipe and conduit work

## Measuring Tapes



Stock No.	Length (meter)	Packing	Order No.
BMPM3	3	1	804015
BMPM5	5	1	804016
BMPM8	8	1	804017

- Tough and durable construction
- Dual scale-- metric and imperial

## Angle Locator

Packing: 1

YA328A  
Order NO.: 804022



- Precise, accurate tool to determine angle measurements
- Ideal for checking drive shaft angle
- Red degree indicator located behind numbers for exact reading of graduations
- English and metric scales molded into base of tool in 1/8" and DM
- Large 1 7/8" x 7/8" magnet inserted in base for secure retention

# Measuring & Other Hand Tools

## Measuring Tools

### Combination Measuring Set

Packing: 1

SQUARECOMB12

Order NO.:804023



Stock No.	Description	Order No.
SQUAREB180	Square Protractor Head	1 804026
RULER12BSQ	Steel Rulers, 12"	1 804027
SQUAREB90	Square Sliding Head	1 804025
SQUAREB45	Square Sliding Head 45°	1 804028

- Set includes SQUAREB180 Protractor, RULER12BSQ steel ruler plus SQUAREB90 and SQUAREB45 sliding heads in fitted storage case

### Machinist's Measuring Set

Packing: 1

SQUAREB12

Order NO.:804024



Stock No.	Description	Order No.
SQUAREB90	Square Sliding Head	1 804025
RULER12BSQ	Steel Rulers, 12"	1 804027

- Set includes SQUAREB90 sliding head and RULER12BSQ steel ruler in fitted storage case

### Dividers, 6"

Packing: 1

CNT6521

Order NO.: 804057



- Spring type divider has virtually no torsion or side play
- Previous part number was PMF129

### Digital Caliper

Packing: 1

MCAL6A

Order NO.: 804029



- Gauge is 0" to 6" (0 to 150mm) in 0.0005" (0.01mm) resolutions
- Use for inside, outside, depth and step measurements
- Inch/metric conversion with one button
- Large LCD display
- Hardened stainless steel frame
- Conform to standard : GB1214

### Digital Caliper

Packing: 1

MCAL12A

Order NO.: 804030



- Essential tool for working on larger vehicles, trucks, tractors and earth moving equipment
- Range is 0" to 12" (0 to 305mm) in 0.0005" (0.01mm) resolutions
- Use for inside, outside, depth and step measurements
- Inch/metric conversion with one button
- Large LCD display with floating zero set
- Locking nut and thumb roll for smooth action
- Conform to standard : GB1214

### Dial Type Caliper

Packing: 1

PMF147A

Order NO.: 804031



- Gauge is 0" to 6" in high (0.001" increments) and metric (0.1mm increments)
- Includes storage case
- Conform to standard : GB1214

# Measuring & Other Hand Tools

## Measuring Tools

### Digital Micrometers



Stock No.	Range (mm)	Increments (mm)		Order No.
MIC1MB	0-25	0.01	1	804032
MIC2MB	25-50	0.01	1	804033
MIC3MB	50-75	0.01	1	804034
MIC4MB	75-100	0.01	1	804035
MIC5MB	100-125	0.01	1	804036

- MIC103MB Digital Metric Micrometer Set includes: MIC1MB, MIC2MB and MIC3MB

### Digital Micrometers



Stock No.	Range (inches)	Increments (inches)		Order No.
MIC1B	0-1	0.0001	1	804037
MIC2B	1-2	0.0001	1	804038
MIC3B	2-3	0.0001	1	804039
MIC4B	3-4	0.0001	1	804040
MIC5B	4-5	0.0001	1	804041

- MIC103B Set includes: MIC1B, MIC2B and MIC3B

### Outside Micrometers



Stock No.	Range (inches)	Increments (inches)		Order No.
MICB1B	0-1	0.0001	1	804042
MICB2B	1-2	0.0001	1	804043
MICB3B	2-3	0.0001	1	804044
MICB4B	3-4	0.0001	1	804045
MICB5B	4-5	0.0001	1	804046

- MICB103B Set includes: MICB1B, MICB2B, MICB3B

### Electronic Digital Micrometers

Packing: 1

MICED1B  
Order NO.: 804048



- Display reads to 0.00005" (0.001mm)
- Zero set for absolute and incremental measuring modes
- Auto shut-off after 10 minutes
- Insulated frame, hardened body, carbide tipped anvil, positive locking clamp and ratchet stop thimble

### Inside Micrometer Set, 7 pcs

Packing: 1

MICINSIDE12  
Order NO.: 804047



- Tubular design
- Range is 2" to 12" in .001" increments
- Includes inside micrometer head and a series of coil spring pressure contact rods

### Depth Micrometer Set

Packing: 1

DM6  
Order NO.: 804049



Stock No.	Description		Order No.
DM61	4" rod	1	804050
DM62	5" rod	1	804051
DM63	6" rod	1	804052
DM64	7" rod	1	804053
DM65	8" rod	1	804054
DM66	9" rod	1	804055
DM67	Micrometer Head	1	804056

- Measure depths of slots, counterbores, holes and keyways up to 6" in depth
- 4" satin chrome base for greater stability
- Graduated in .001" increments
- Includes fitted storage case

## Measuring & Other Hand Tools

### Penlight, Blue

Packing: 1



ECFB200BL  
Order NO.: 805001

- High intensity 3 watt LED, 100 lumen penlight
- Extremely bright light output
- Uses (3) AAA alkaline cells
- Only 6.25" in length and 1/2" in diameter
- Includes pocket clip and protective rubber tip
- Blue in color

### Penlight, Silver

Packing: 1



ECFB200S  
Order NO.: 805002

- High intensity 3 watt LED, 100 lumen penlight
- Extremely bright light output
- Uses three AAA alkaline cells
- Only 6.25" in length and 1/2" in diameter
- Includes pocket clip and protective rubber tip
- Silver in color

### Aluminum Police Style Flashlight

Packing: 1



ECF201A  
Order NO.: 805009

- 3 watt LED flashlight features a K2 Luxeon LED that produces 130 lumens
- The flashlight body is aerospace grade extruded aluminum with heavy anodization
- Average run time is 10-hours on 2D alkaline batteries
- Reflector is highly polished for maximum light output
- The switch is self cleaning
- Water and shock resistant
- Requires 2 "D" cell batteries (not included)

## Flashlights

### Compact Flashlight

Packing: 1



BLED1  
Order NO.: 805018

- Adjustable beam by sliding zoom
- Anodized aluminum casing
- LED type : CREE XP-E-R2
- Luminance flux:195mm
- Switch mode: High Light, Low Light, Strobe, SOS
- Power Source : 3x AAA alkaline batteries
- Waterproof grade: IPX6

### Bendable Light

Packing: 1



ECF1600  
Order NO.: 805006

- Heavy duty barrel handle and switch
- Features 10 flexible shaft and 3/16" high intensity lamp
- Includes (2) AA batteries

### Bendable Light

Packing: 1



YA5100B  
Order NO.: 805007

- Features brilliant krypton lamp on a slender, 15" long, flexible shaft
- Includes 24" extension cover, which can make the light almost 40" long for difficult-to-view areas
- 3/16" lamp diameter
- Runs on (2) AA alkaline batteries

### LED Under Hood Light

Packing: 1



ECUB9500AP  
Order NO.: 805011

- Extendable lightweight aluminum holder
- Length of 47"-71" covers a wide range of vehicles
- 95 ultra bright LED's provide 900LUX at 0.5m
- Rubber coated hooks protect paintwork from damage
- Cordless design improves safety and convenience
- 4400 mAh battery provides 5 hours constant light output
- Test results show 27% brighter, +28% longer life than primary competitive unit

# Measuring & Other Hand Tools

Flashlights

## Rechargeable LED Shop Light



### Rechargeable LED Shop Light

Packing: 1

ECFLED215AP  
Order NO.: 805013



- Rechargeable and cordless compact shop light that can be taken anywhere
- 21 front-facing LEDs provide high light output to work surfaces
- 5 LED spot light provides up to 15 hours of continuous illumination
- Multi-function switch toggles between front and top LED illumination
- 180° folding design offers the ultimate in flexible positioning
- Dual magnetic design for parallel use or multi angle

### Multi LED Shoplight

Packing: 1

ECFPKT20AP  
Order NO.: 805015



- 20 high output LEDs provide 1,600 lux of light
- Strong rechargeable Lithium-ion battery lasts up to 4 hours
- 360 degree folding design enables flexible light positioning
- Magnetic base allows placement on metal surface
- Handy pocket size with belt clip for great portability
- CE/UL certificated charger 110-240V

# Measuring & Other Hand Tools

## Rechargeable Shop Light

Packing: 1



- IP65 rating, heavy duty and robust
- Vapor, water and dust proof
- Rechargeable, Li-ion battery with 4 hours constant output
- 3 pcs magnets, totally hand free works, easier for technicians to operate
- 1 hook new design , rotate 360 degree
- 1 Stand to support this light work on 3 angles
- 180 degree bendable. Offering all lighting angle possibilities.
- CE/UL certificated charger

ECFBP20AP  
Order NO.: 805014

## Rotating Light Mag Base

Packing: 1



- 24 high output LEDs project light in wide area
- Provides 40 lumens light output
- (3) AAA alkaline cells provide 4~5 hours of light
- Strong magnet mounts securely on any magnetic surface
- Mounts under-hood, under-dash, under-car wherever it is needed
- Direct light to any angle using rotating magnetic base
- Keeps hands free to do the work, while lighting the work area

ECFLED24  
Order NO.: 805005

## Flood Light

Packing: 1

ECFLOODAP  
ECFLOODAPS1 (Stands, sold separately)  
Order NO.: 805017



- Powerful and uniform illumination ideal for lighting working environment
- Utilizing LED reduces energy consumption
- 70 SMD LED provides up to 2500 lumen, 35W
- IP65 – Resistant to water and dust infiltration
- Compact and robust construction with strong rubber protection frame
- With flexible stand to allow placing the lamp in the desired angle
- Total aluminum design for better heat distribution

# Flashlights / Safety

## LED Headlight

Packing: 1



- LED headlight for applications requiring hands free lighting
- Bright watt LED never needs replacing
- Pivoting head and adjustable headband
- Water resistant
- 30 hours continuous run time on (3) AAA alkaline batteries

ECFHEAD1A  
Order NO.: 805003

## Washable Work Gloves



Stock No.	Size	Color	Packing	Order No.
GLOVE103MA	Medium	Black	1	806003
GLOVE103LA	Large	Black	1	806001
GLOVE103XLA	X-Large	Black	1	806005
GLOVE103MAB	Medium	Blue	1	806004
GLOVE103LAB	Large	Blue	1	806002
GLOVE103XLAB	X-Large	Blue	1	806006

- Gloves feature stretch knit with padded back to provide extra feel and flexibility to grasp small objects
- Extra knuckle protection on back of fingers
- Heat resistant synthetic double layered leather palm for longer life
- Elastic cuff with hook and loop closure

## Abrasion Resistant Nitrile Gloves



Stock No.	Size	Packing	Order No.
GLOVE400S	Small	3	806009
GLOVE400M	Medium	3	806008
GLOVE400L	Large	3	806007
GLOVE400XL	X-Large	3	806010
GLOVE400XXL	XX-Large	3	806011

- Nitrile dipped coating for protection on dirty jobs
- Ergonomically pre-curved design gives you comfort at all times
- High abrasion resistance protects hand on sharp edges and rough castings
- Incredible grip and dexterity on wet and dry surfaces
- Lightweight nylon shell provides a nice snug fit
- CE rated for abrasion, blade cut, tear and puncture resistance



# Measuring & Other Hand Tools

## Safety

### Welders Gloves

Packing: 1



YA427B  
Order NO.: 807030

- Helps protect hands from sparks when welding
- Leather construction with added insulation for heat protection
- Reinforced palm for durability

### Tig Welding Gloves

Packing: 1



YA4282  
Order NO.: 807032

- Ideal for TIG welding processes
- Pigskin material for precise control
- Helps protect hands from heat and sparks
- Thick leather cuff for wrist protection

### Welding Sleeves 1 Pair

Packing: 1



YA4280  
Order NO.: 807031

- Helps protect arms from sparks when welding or cutting
- Elastic bands at each end of sleeve
- Constructed of flame retardant fabric
- 18" long
- 1 pair

### Face Shield

Packing: 1



Shield Style	Shield Size (inches)
Flat	7 3/4 x 15 1/4
Shield Included	Replacement Shields
Clear	GA225-1 (with PETG) GA225-2 (with PC)

GA225  
Order NO.: 806012

- Adjustable, cushioned head band is removable
- Face shield provides impact resistance
- Includes visor (GA225-1) with PETG (impact resistance preferred)
- Optional visor (GA225-2) with PC (high temperature resistance) is available

### Safety Glasses



Stock No.	Lens	Frame	Packing	Order No.
GLASS30R	Clear	Red	1	806016
GLASS30BK	Clear	Black	1	806015
GLASS31R	Clear	Red	1	806018
GLASS31BK	Clear	Black	1	806017

- Complies with ANST Z87.1-2003
- Lens provide 99.9% UV protection
- Angle and length adjustable temples provide various suitable fitting
- Soft nose pad and soft temple tips provide comfort for long-time wearing
- Anti-fog lens coating with anti-scratch protection
- GLASS30BK and GLASS30R have a ventilation channel between frame and lens

### Ear Protector

Packing: 1



Noise Reduction Rating, dB	Headband
28	Cushioned
Ear Piece	Weight (lbs.)
Cushioned	0.77

GA3200  
Order NO.: 806013

- Noise reduction rating of 28 dB for protection
- Lightweight and comfortable with cushioned headband
- Cushioned ear piece for a comfortable and snug fit that keeps out noise
- Each ear piece pivots to provide a comfortable and secure fit
- Blue hard protective ear cups with Blue-Point® logo in white
- Each ear piece easily adjusts to fit a variety of sizes

### Ear Protector, Ear Plug Style

Packing: 1



Noise Reduction Rating, dB	Headband	
25	Plastic	
Ear Piece	Ear Piece Replacements	Weight (lbs.)
Foam	YA160A1	0.06

YA160A  
Order NO.: 806014

- 25 dB noise reduction rating
- Cushioned ear piece for comfort and snug fit to keep out noise
- Non-conductive
- Includes extra set of foam ear piece and reusable storage bag

# Measuring & Other Hand Tools

Miscellaneous

## Pick Up Tool

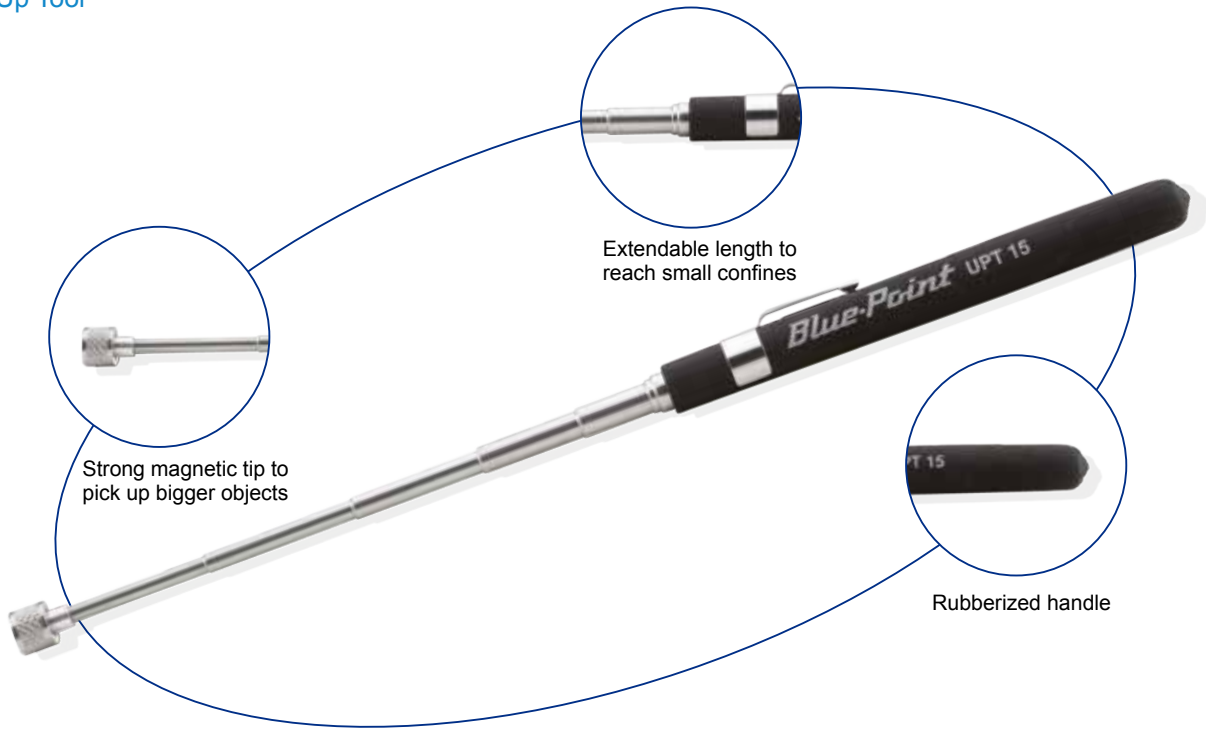

### Pick Up Tool

Packing: 1



PHT5

Order NO.: 807004

- Lifts 2.5 lbs.
- Chrome plated shaft extends from 5 1/2" to 25 1/2"
- Black cushion grip will not slip in oily or wet hands
- Includes pocket clip
- Hinged head magnetic pick up tools
- Powerful magnets are fitted into the brass sleeve
- Adjustable hinged heads

### Pick Up Tool

Packing: 1



PT5CBL

Order NO.: 807006

- This 5 7/8" tool extends to 25 9/16"
- Magnet lifts up to 2 lbs.
- Includes pocket clip
- Blue
- Hinged head magnetic pick up tools
- Powerful magnets are fitted into the brass sleeve
- Adjustable hinged heads

### Pick Up Tool

Packing: 1



PT5C

Order NO.: 807005

- This 5 7/8" tool extends to 25 9/16"
- Magnet lifts up to 2 lbs.
- Includes pocket clip
- Chrome
- Hinged head magnetic pick up tools
- Powerful magnets are fitted into the brass sleeve
- Adjustable hinged heads

### Pick Up Tool

Packing: 1



UPT15

Order NO.: 807007

- Lifts 2 lbs.
- 6 5/8" long, and extends to 33 1/4"
- Hinged head magnetic pick up tools
- Powerful magnets are fitted into the brass sleeve
- Adjustable hinged heads

# Measuring & Other Hand Tools

## Pick Up Tool

Packing: 1



UPT2FL  
Order NO.: 807008

- 29" aluminum shaft can be easily bent at any angle to retrieve dropped metal objects in hard to reach areas
- Power cap slides over the magnet and shield its sides from attaching to unwanted metal surfaces
- Will pick up 5 lbs. with the power cap
- Textured cushion pistol grip will not slip in wet or oily hands

## Pick Up Tool

Packing: 1



UPT35  
Order NO.: 807009

- Lifts 4 1/2 lbs.
- 6 5/8" long, and extends to 33 1/4"
- Hinged head magnetic pick up tools
- Powerful magnets are fitted into the brass sleeve
- Adjustable hinged heads

## Pick Up Tool

Packing: 1



UPT50A  
Order NO.: 807010

- Lifts 10 lbs.
- 6 5/8" long, and extends to 33 1/4"
- Hinged head magnetic pick up tools
- Powerful magnets are fitted into the brass sleeve
- Adjustable hinged heads

## Pick Up Tool

Packing: 1



UPT65  
Order NO.: 807011

- Perfect for retrieval of heavy ferrous objects in hard to reach areas
- Goblet shaped magnetic head pushes the flux to the front of the magnet enabling the user to lift 16 lbs
- Head shields the sides of the magnet from attaching to unwanted ferrous surfaces
- Telescopes from 9" to 34 1/4" (229 to 870mm)
- Stainless steel handle is strong, lightweight and inhibits corrosion
- Cushion textured pistol grip will not slip in wet or oily hands

## Miscellaneous

### Inspection Mirrors



Stock No.		Order No.
UIM125	1	807001
UIM225	1	807002
UIM325	1	807003

- **UIM125 Telescoping Inspection Mirror**
- 1 1/4" diameter mirror. 6 1/2" long, and extends to 35"
- **UIM225 Telescoping Inspection Mirror**
- 2 1/4" diameter mirror. 6 1/2" long, and extends to 35"
- **UIM325 Telescoping Inspection Mirror**
- 3 1/4" diameter mirror. 6 1/2" long, and extends to 29 1/2"

### Hose Nozzle

Packing: 1

NOZZLE360A  
Order NO.: 807014



- Turns any standard 5/8" hose into a multi-function cleaning tool
- Five different spray patterns for multiple applications
- Wash/rinse vehicles or water plants using a softer, cascading stream
- Clean pools, deck and driveways with heavy duty stream
- Clean service bays, shop floors and blast mud/dirt from vehicles with a powerful jet stream
- 360° jetted nozzle is engineered from rugged extruded aluminum, forged stainless steel, high grade fiberglass and comfort grip santoprene rubber
- Patented 2-way shut off

### Rivet Tool

Packing: 1

HP2  
Order NO.: 807012



- Has four nose pieces for 3/32" to 3/16" diameter rivets
- For 1/8" thru 5/8" thickness
- Made of aluminum alloy



# Measuring & Other Hand Tools

## Deburring Tool

Packing: 1



- Easily deburr drilled and machined holes
- Push button locking collet enables quick, easy blade changes
- Includes three round head deburring blades
- Blades conveniently store in handle of tool
- Weighs 1 lb
- 6" long

DEBUR300

Order NO.: 807013

## Magnetic Holder

Packing: 1



- Magnet has "on/off" switch
- Base is 2 3/8" x 1 7/8" x 2 1/2"
- Post is 7" x 15/16"
- Rod is 6" x 25/64"
- Will grip flat or curved metal surfaces

CM6416

Order NO.: 807016

## Deluxe Air Vacuum System

Packing: 1



Stock No.	Air Consumption, Average, DFM (SCFM) [l/min]	Sound Level, Free Speed, dBA
AV1000A	3 (21) [84.95]	81.2
Sound Level, Working (dBA)	Recommended Hose Size (inches)	Length (without bag), inches (mm)
81.2	3/8	13 (330)
Brush Size, inches (mm)	Bag Size, inches (mm)	Weight, lbs. (kg)
1 1/8 x 2 5/8 (28.5 x 66.7)	6 1/2 x 11 1/4 (165 x 285)	0.88 (0.4)

- Ideal for vehicle media installation and body shops plus other applications in need of picking up dust, metal shavings or broken glass
- Large collection bag includes a debris baffle and sliding bag clamp for emptying debris
- Lightweight ergonomic handle design
- Includes 8.7" aluminum extension tube, 8 1/2" plastic extension tube (AV1000A10), flexible extension tube (AV1000A9), pointed nozzle (AV1000A11) and crevice tool with brush (AV1000A8)

AV1000A

Order NO.: 807015

## Miscellaneous

### Bench Vice



Stock No.	Jaw Width	Packing	Order No.
BLPMV4	4" jaws	1	807017
BLPMV5	5" jaws	1	807018
BLPMV6	6" jaws	1	807019

- Single piece steel blocks for higher load capacity
- Extended anvil
- Lubrication points for maintenance
- Optional swivel base
- Capacity range from 3.5 ton to 9 ton at maximum opening
- Reinforced cantilever support
- Interchangeable jaws
- Diamond ground for better grip
- Heavy duty cast iron construction
- Precise jaw alignment
- Rolled thread spindle for easy locating and tightening parts
- Protected spindle

### C-Clamps



Stock No.	Capacity (inches)	Throat Depth (inches)	Packing	Order No.
CL404VIS	0 - 4 1/2	3 1/4	1	807027
CL406VIS	0 - 6 1/16	3 5/8	1	807028
CL408VIS	0 - 8 1/4	5	1	807029

- Similar to CL series c-clamps
- High visibility models conform to OSHA safety color standard for physical hazards regulation #19110.144
- 3/4" spindle diameter

### Welding Helmet, Auto Darkening

Packing: 1



YA4603

Order NO.: 807033

- Two arc sensors for enhanced lens triggering
- Fixed shade #10
- Clear shade of 3.5
- Fixed delay
- Viewing area 1.38"x 3.81"
- Solar powered
- Fixed shade auto darkening welding helmet has a lens that is designed for carbon arc welding processes. Two arc sensors provide a range of sensitivity to trigger the lens under most welding conditions.
- Meets ANSI Z87.1-2003, CE, DIN 4647 PZ, EN379, EN175, CSA Z 94.3 and AS/NZS 1338.1 standards

# Measuring & Other Hand Tools

## Standard Duty Welding Kit

Packing: 1

WE200A

Order NO.: 807034



Stock No.	Description
HRC1401340	85 Weld Handle with Check Valves
HRC1300380	72-3 Cut Attach
HRC9100614	D-85 Weld Mixer
HRC4300557	3/16 x 20 Twin Hose
HRC4304482	Cover Goggle
HRC9004486	Striker
WE200A1	Oxygen Regulator
WE200A2	Acetylene Regulator
HRC1502172	6290-1 #1 AC Cut Tip
HRC1600890	23-A-90-5 #5 Weld Tip
HRC1600870	23-A-90-3 #3 Weld Tip
HRC1600850	23-A-90-1 #1 Weld Tip

### Optional Accessories

Stock No.	Description
HRC1800710	J-63-1 Heating Assembly
HRC1600840	23-A-90-0 #0 Weld Tip
HRC1600860	23-A-90-2 #2 Weld Tip
HRC1600880	23-A-90-4 #4 Weld Tip
HRC1502170	6290-00AC #00AC Cut Tip
HRC1502171	6290-0AC #0AC Cut Tip
HRC1502173	6290-2AC #2AC Cut Tip
HRC1502174	6290-3AC #3AC Cut Tip
HRC4301650	88-5FBT PR. Torch Flash Arrestor
HRC9000160	E-9 Tip Cleaner (2 pc tip)
HRC9004484	Replacement Flints

- Use for auto repair, construction, fabrication, manufacturing and maintenance
- Cuts up to 1" and welds up to 1/8"
- Cuts up to 4" and welds up to 1/2" with optional tips
- Durable and strong forged brass regulator
- Regulator diameter 2 1/4" allows precise control of gas
- Internal lter keeps particles from entering regulator
- PTFE Teon seat ensures positive sealing
- Handle shut-o valve color coding provide ease in identifying the corresponding gas control
- Two piece cutting tip allow easy cleaning
- High quality hose oers reduced tear resistance and increased exibility

## Miscellaneous

### Industrial Paper

BPAP1

Order NO.: 807035



Stock No.	Size(mm)	Color	Pieces / Roll	Packing
BPAP1	31*34cm	White	1100	1

- Excellent for cleaning off oil and residue from tools, hardware, equipment and mechanical components
- Tough for industrial use
- Lint free to prevent electrostatic charge as well as a clean surface
- Made from cellulous and polypropylene for better absorbability

### Industrial Paper

BPAP2

Order NO.: 807036

Packing: 1



Stock No.	Size(mm)	Color	Pieces / Roll	Packing
BPAP2	25*35cm	Green	300	6

- Excellent for cleaning off oil and residue from tools, hardware, equipment and mechanical components
- Tough for industrial use
- Lint free to prevent electrostatic charge as well as a clean surface
- Made from cellulous and polyethylene for softness and finer surface

### Roller Stand

BPAPS1

Order NO.: 807039

Packing: 1



- Foldable Metal Stand for BPAP1





Shop & Technician Tools

*Blue-Point*



Our shop and technician tools focus mainly on the automotive industry with commonly used items like multimeters and protective gloves, to equipment and devices specially made for vehicle engine code reading and valve servicing. We have almost a tool to cater for all job tasks commonly done in the automotive industry.



Testing and Electronics

132

Special Tools

134

Automotive Specialty Tools

136

# Shop & Technician Tools Testing and Electronics

## Borescope

Packing: 1

BKB6500  
Order NO.: 901017



### SPECIFICATIONS:

Optimal Viewing	1" to 12" (2.5 cm — 30 cm)
Power Supply	Li-Ion Battery 3.7V, 4200 mAh
Estimated battery run time	3-5 hours
Weight	1lbs 14oz. (0.5 kg)
Internal Memory	512 MB storage
Built in micro SD card bay	high capacity compatible
Dimensions	7" (17.8 cm) L x 3.63" (9.2 cm) W x 6.25" (15.9 cm) H
Temperature	2°F to 113°F (0°C to 45°C)
Humidity	5% to 95% non-condensing (display unit)
Storage Temp	-4°F to 158°F (-20°C to 70°C)
Water Resistance	Imager to 10' (3.05 m) depth

- 4.3" TFT LCD Display with a native resolution of 480 RGB X 240
- Digital camera technology provides superior imagery under all light conditions compared to analog cameras
- Dual view Imager allows the user to see forward or 90° to the side with one touch
- Easy to use touch screen interface
- File naming for convenient file management
- Text annotation aids in documentation
- Coil cord imager handle allows for greater maneuverability while the base stays at a comfortable viewing position
- Low optical distortion provides superior image quality
- Capture still images at 640 X 480 resolution
- Capture video at a rate of 20 fps (frames per second)
- 2X digital zoom
- Excellent near-field focus (0.5" to 12")
- Imaging head made of robust aluminium
- Resistant to common automotive and industrial chemicals
- Super Bright LED
- 8.5mm outside diameter fits in most spark plug holes
- Built in microphone and speaker for recording comments and sounds
- 36" long imager is coated with a non conductive covering for protection of surfaces and safety
- Mini-USB connector for uploading images and video to a computer
- Analog video out to a larger format screen or recording device
- Rubber over-mold on all contact/gripping areas for added ergonomics and durability
- Integrated rubberized magnets secure unit to metal surfaces
- External microSD Card access
- External mini-USB access
- Integrated three position stand for added convenience
- Rechargeable internal Lithium-ion battery
- D/C plug allows the unit to be used while battery is being charged

## Borescope

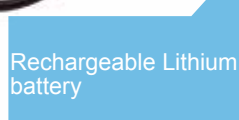
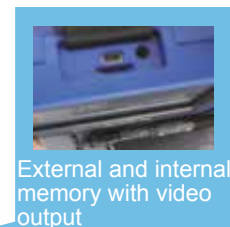

- Optimal focal length of 1/2 inch
- High intensity LED light



# Shop & Technician Tools Testing and Electronics

## Pick Sets



Stock No.	Description	Length (inches)	Packing	Order No.
PSLR4-1	Hook Pick	9 3/4	1	901011
PSLR4-2	90° Hook Pick	9 3/4	1	901012
PSLR4-3	Straight Pick	9 3/4	1	901013
PSLR4-4	Complex Pick	9 3/4	1	901014
PSLR4-5	Combo Pick	9 3/4	1	901015
PSLR4-6	Double Angle Pick	9 3/4	1	901016

- **PSLR4** (Order No.901010) extra long pick set includes PSLR4-1 thru PSLR4-4 (4 pcs) in vinyl storage pouch
- **PSLR6** (Order No.901001) extra long pick set includes PSLR4-1 thru PSLR4-6 (6 pcs) in vinyl storage pouch

## Tweezer Kit, 5 pcs

Packing: 1

TZK5

Order NO.: 901006



- Includes five tweezers neatly arranged in a vinyl zipper pouch
- All stainless steel construction
- Pointed tweezers w/plain ends, 4 3/8" long
- Self closing tweezers w/plain ends, 4 1/2" long
- Sharp point utility tweezers w/bent plain ends, 7" long
- Sharp point utility tweezers w/plain ends, 7" long

## Tweezer Kit, 7 pcs

Packing: 1

TZK7

Order NO.: 901007



- Includes seven tweezers neatly arranged in a black vinyl zipper pouch
- All stainless steel construction
- Pointed tweezers, 4 3/8" long
- Curved head utility tweezers, 6 3/4" long
- Sharp pointed utility tweezers, 7" long
- Side locking tweezers, 6" long
- Spade point tweezers, 4 3/8" long
- Weighted solder tweezers, 6" long

## Wire Cutter

Packing: 1

PWC27

Order NO.: 901005



Description	Length (inches)	Strips AWG Sizes
Automatic Wire Stripper	6 1/4	10, 12, 14, 16, 18, 20, 22
Strips Metric Sizes (mm)	Application	Replacement Blades
—	Strips PVC, THHN, and THWN	PWC27-7

- One-step stripping enhances productivity
- Spring-action motion increases leverage and reduces operator fatigue
- Precision ground, knife-type blades provide clean, accurate stripping
- Cleanly strips wire up to full 7/8" (22mm)

## Wire Stripper

Packing: 1

PWC28A

Order NO.: 902016



Description	Length (inches)	Strips AWG Sizes
Wire Stripper/Cutter/Crimper/Bolt Cutter	8 1/4	10, 12, 14, 16, 18, 20, 22 Stranded, 8, 10, 12, 14, 16, 18 Solid
Strips Metric Sizes (mm)	Application	Replacement Blades
10-22 Non-Insulated Terminals and Crimp Sleeves	—	—

- One-step stripping enhances productivity
- Spring-action motion increases leverage and reduces operator fatigue
- Precision ground, knife-type blades provide clean, accurate stripping
- Cleanly strips wire up to full 7/8" (22mm)

## Wire Stripper

Packing: 1

PWC6

Order NO.: 901004



Description	Length (inches)	Strips AWG Sizes
Wire Stripper/Cutter/Pliers	6	10, 12, 14, 16, 18, 20
Strips Metric Sizes (mm)	Application	Replacement Blades
2.6, 2.0, 1.6, 1.3, 1.0, 0.80	Strips PVC, THHN, and THWN	—

## Wire Stripper

Packing: 1

PWC12A

Order NO.: 901002



Description	Length (inches)	Strips AWG Sizes
Wire Stripper/Cutter/Crimper	9 1/2	10, 12, 14, 16, 18
Strips Metric Sizes (mm)	Application	Replacement Blades
10-18 Insulated and Non-Insulated 7-8mm Ignition Terminals	—	—

## Wire Stripper

Packing: 1

PWC14

Order NO.: 901003



Description	Length (inches)	Strips AWG Sizes
Wire Stripper/Cutter/Crimper/Bolt Cutter	8 3/4	10, 12, 14, 16, 18, 20, 22
Strips Metric Sizes (mm)	Application	Replacement Blades
10-22 Insulated and Non-Insulated 7-8mm Ignition Terminals	—	—

# Shop & Technician Tools Special Tools

## Wire Cutter

Packing: 1



Description	Length (inches)	Strips AWG Sizes
Micro Shear Wire Cutters	5 1/8	Up to 20
Strips Metric Sizes, (mm)	Application	Replacement Blades
Up to .80	—	—

PWC19

Order NO.: 902015

## Crimp Tool

Packing: 1



PWC34

Order NO.: 902013

- Double compound action with ratchet control for almost effortless operation
- Use with insulated connectors on 10 to 22 gauge wire
- For easy, efficient, single squeeze crimping of modular connectors
- Both primary and secondary crimps are made simultaneously to factory specifications
- Has a comfortable ergonomic design and full cycle ratchet action

## Power Bit Set, 52 Pcs

Packing: 1



YA52PBSQC

Order NO.: 902005

- Ideal for use with cordless drills and screwdrivers
- Includes:
  - 49 1/4" hex shank bits in short and long lengths
  - 2 hex adaptors
  - Flat tip bits (long): 6-8, 8-10, 10-12
  - Hex bits (short): 1/8", 9/64", 5/32", 3/16", 7/32", 1/4", 9/32"
  - Hex bits (long): 5/32", 3/16", 7/32"
  - PHILLIPS® tip bits (short): #1, #2 (2 each), #3
  - PHILLIPS® tip bits (long): #1, #2, #3
  - TORX® tamper resistant bits (short and long): T10, T15, T20, T25, T27, T30, T40
  - Square bits (short and long): #1, #2, #3
  - Clutch bits (short and long): 5/32", 3/16"
  - Double end bits: 6-8 x #2 PHILLIPS®, 8-10 x #3 PHILLIPS®
  - Adaptors: 1/4" hex female to 1/4" hex female, 1/4" hex male to 1/4" square male, 1/4" hex quick change chuck

## Pinch Bars



Stock No.	Sq. Stock (inches)	Edge (inches)	Length (inches)	Packing	Order No.
1412A	1/2	5/8	14	1	902006
1658C	1/2	5/8	16	1	902010
2420A	3/4	15/16	20	1	902011
2430C	3/4	5/8	30	1	902012
2438C	3/4	7/8	38	1	902007
2842C	7/8	1	42	1	902008

## 41.5 in. Curved Fiberglass Prybar

PBFG415



- Drop forged, hardened steel wedge end with rust-resistant black finish, is chemically bonded to fiberglass handle
- 50,000 strands of fiberglass are sleeved by a polypropylene jacket for comfort and variable hand placement during use
- About one-half the weight of a steel prybar of the same length and less flexible than a steel prybar for greater leverage
- Polypropylene sleeve is resistant to heat and cold for greater comfort in all temperatures

## Magnetic Trays



Stock No.	Description	Sizes	Packing	Order No.
MRB5A	Magnetic tray, Round	Round 152mm diameter	1	902018
MRB10A	Magnetic tray	250mm x 140mm	1	902019
MRB12A	Magnetic tray	355mm x 140mm	1	902020
MRB15A	Magnetic tray	290mm x 265mm	1	902021

- Securely holds small parts and tools
- Magnetically attaches to any flat iron or steel surface
- Material: 430 Stainless Iron

# Shop & Technician Tools Special Tools

## Magnetic Tool Holder

Packing: 1

MAGWRENCH  
Order NO.: 902022



- Industrial strength magnets keep it secured to a metal surface
- Holds tools for quick and easy access
- Chrome plated steel bar with chrome plated nylon ends
- Overall size is 20" (with approximately 12" of magnetic holding space)

## Blow Gun

Packing: 1

YA105020  
Order NO.: 902001



- 20" bent nozzle
- Trigger provides variable air flow control
- Lightweight body with ergonomically designed grip provides comfort and control
- Insulated handle prevents cold hands
- Venturi tip directs air sideways if tip end is obstructed
- Reinforced 1/4"-18NPT inlet
- Maximum air pressure: 232 PSI (16 BAR)

## Blow Gun

Packing: 1

YA1055B  
Order NO.: 902002



- Variable flow trigger offers precise air flow control
- Six-outlet "star tip" delivers an even distribution of air
- 4" Full Flow tube
- Ergonomic handle design for increased comfort
- Complies with OSHA safety standards
- Air Inlet: 1/4" NPT
- Maximum Working Pressure: 175 PSI (12 bar)
- Vented Tip
- Triggers regulate airflow from partial to full line pressure
- Valve has no cutoff and no restrictions
- Each tip is side vented
- Each gun includes hanging hook and paddle-type air control lever

## Torx Ball Hex Bit Set, 11pcs

Packing: 1

SDM11KT  
Order NO.: 902004



- 1/4" shank bits for use in difficult access applications where fastener cannot be approached straight-on
- 11 pc. set includes:
- TORX® Ball Hex Bits: T10, T15, T20, T25, T27, T30, T40, T45, T50
- Magnetic Insert Bit Holder
- 1/4" Female Hex to 1/4" Female Sq. Dr. Adaptor
- All components store in case with belt clip

## Master Ball Hex Bit Set, 32pcs

Packing: 1

SDM32KT  
Order NO.: 902003



- 1/4" shank bits for use in difficult access applications where fastener cannot be approached straight-on
- 32 pc. set includes:
- Fractional Ball Hex Bits: 3/32", 7/64", 1/8", 9/64", 5/32", 3/16", 7/32", 1/4", 5/16", 3/8"
- Metric Ball Hex Bits: 2, 2.5, 3, 4, 5, 6, 7, 8, 9, 10mm
- TORX® Ball Hex Bits: T10, T15, T20, T25, T27, T30, T40, T45, T50, T55
- Magnetic Insert Bit Holder
- 1/4" Female Hex to 1/4" Female Sq. Dr. Adaptor
- All components store in case with belt clip



# Shop & Technician Tools Special Tools / Automotive Specialty Tools

## Prybar Set

Packing: 1



- Set includes 1412A (14") and 2420A (20") pinch bars, 7031A close quarter bar (16") and BPPC1878 flat chisel (18")
- All bars have a 100% black oxide finish

BLPPB704  
Order NO.: 902009

## Digital Drum Gage

Packing: 1



- Measures automotive and heavy duty brake drums
- Pointed anvils and 4.25" long arms allow increased measurement accuracy and coverage
- Easy to read digital display with inch/metric conversion
- Selectable depth stops for easier use
- Range 6"-20.65"/150mm-515mm
- Graduations .0005"/.01mm

DG530  
Order NO.: 903029

## Cable Cutter

Packing: 1



- For cutting battery cables and other soft metal cables
- Has vinyl covered handles
- 7 1/2" long

PWC80A  
Order NO.: 902014

## Pad Spreader

Packing: 1



- For use on most domestic and import cars and light duty trucks with single piston disc brakes without parking brakes
- Compresses the disc brake piston for easy pad installation

YA2440  
Order NO.: 903128

## Bender, Tubing

Packing: 1



- Makes left, right, or offset bends up to a 90° angle
- Degrees shown for accurate bending angle
- Handles 3/16", 1/4", 5/16", and 3/8" (4, 6, and 8mm) OD aluminum, copper, and stainless steel tubing
- Aluminum unit is 8 1/4" long when opened

TBS200A  
Order NO.: 902017

## Brake Rotor Tool

Packing: 1



- Use to rotate piston back into caliper cylinder when replacing pads
- Also rotates parking brake cylinder back into the caliper cylinder on vehicles with four wheel disc brakes
- For 1975 and later Ford and Mercury plus some imports

YA9329A  
Order NO.: 903031

## Gauge Set

Packing: 1



- 5 piece set includes FB300A Bent Blade Feeler Gauge, FB305A Non-magnetic Feeler Gauge, and FB325A General Use Feeler Gauge, plus GA461B and FB360B Spark Plug Gap Gauges in the FBS5-1 Kit Bag

FBS5  
Order NO.: 903027

## Spreader

Packing: 1



- For standard four piston caliper disc brakes
- Frees hands to assemble caliper over rotor
- 6 3/4" long

GA395  
Order NO.: 903129

# Shop & Technician Tools Automotive Specialty Tools

## 4 Ton Portaset

Packing: 1



- 4-ton capacity kit includes hydraulic unit, five "Snap-Set" extensions, spreader plus a full selection of attachments for most push applications
- Automatic pump overload system protects against damage to rams and equipment
- 1/2-ton capacity hydraulic spreader has 2" jaw and spreads from 5/8" to 3 3/4"
- Flex head includes permanently molded rubber pad
- Heavy walled extensions tubes stand up to the toughest loads
- Long handle reduces required pumping effort
- 18 piece set is stored in durable storage case

YA1544A

Order NO.: 903132

## Extractor Set

Packing: 1



- Extracts broken screws from 1/4" to 1/2" diameter
- Comes in a storage case

E1020

Order NO.: 903040

## Extractor Set

Packing: 1



- Extract broken screws from 1/4" to 1" diameter and standard pipe sizes 1/8" to 1"
- Packaged in a storage case

E1025

Order NO.: 903039

## Tap & Die Set

Packing: 1



- Taps and dies from 1/4" to 1/2" in both NF and NC threads, taps and dies from 4-40 thru 12-24 and corresponding dies in Machine Screw Threads, a pipe thread tap and die, plus two die stocks and three tap wrenches, a screw pitch gauge, and a die adjusting screwdriver (41 pcs) in a storage case
- Die size 1/4" to 1/2" and 7 mm to 12 mm are a one-piece, 12-point design that can be turned with a 1" socket wrench (5/8" socket wrench for 3 to 6 mm dies) when working in places where a normal die stock cannot be used

GA541

Order NO.: 903037

## Meter ATV And Motorcycle

Packing: 1



- Peak voltage measurement of secondary ignition systems on all types of vehicles and pleasure craft
- CDI ignition diagnosis on motorcycles, ATVs, and snowmobiles
- Digital Multimeter functions to measure battery, sensor and circuit voltage
- Check continuity of wiring and resistance of ignition wires

MTPV1000

Order NO.: 903041

## Metric Tap & Die Set

Packing: 1



- 40-pc set features 1" single hex non-adjustable dies from 3 to 12mm, a 1/8"-28 BSP die plus taps in the same sizes
- Also includes a die stock, 2 T-handle tap wrenches, a thread pitch gauge, a drill/tap chart and a midget screwdriver, all in a storage case

GAM541

Order NO.: 903038

## Circuit Tester

Packing: 1



- Circuit tester for 6 and 12 volt systems.
- Quickly and safely tests high and low voltages on all vehicles including computerized engine.
- Can be used to detect power, ground and find shorts and breaks.
- High impedance to protect sensitive electronic sensors, microprocessors, electronic ignition components and air bags.
- LED indicates red for power (high) and green for ground (low).
- Insulated alligator clip.

BPECT1

Order NO.: 903151



# Shop & Technician Tools Automotive Specialty Tools

## Exhaust Hanger Removal Pliers

Packing: 1



- For removing hanger brackets from their rubber mounting straps
- Place removal jaw behind the rubber grommet ring and the forcing pin of the pliers on the end of the steel hanger
- When handles are squeezed, the forcing pin pushes the ring off the hanger
- Applications on most domestic and import cars as well as light trucks
- 14" long

YA3202

Order NO.: 903034

## Boot Pliers

Packing: 1



- Straight jaw version of YA824C
- 9 3/4" long

YA824ASTR

Order NO.: 903035

## Boot Pliers

Packing: 1



- 45° offset jaws
- Vinyl coated jaws and handles assure gripping ability
- Use only on automotive type ignition systems
- 9 1/2" long

YA824C

Order NO.: 903036

## Fuse Saver Kit

Packing: 1



- Dual type fuse box connector with 10' cord allows you to move around the vehicle shaking testing wires while looking for the short
- No wasted fuses
- Includes 3 resetting breaker handles: 10, 15 and 20 Amp
- Use when installing radios, CD players, radar detectors and other accessory equipment
- Includes YA8005-7, YA8005-10, YA8005-15 and YA8005-20 in YA8005-PB storage case
- YA8005-5 Fuse Handle and YA8005-EXT are optional accessories for the YA8005 Kit and are not included

YA8005

Order NO.: 903045

## Fuse Buddy Pro Test Kit

Packing: 1



- Great tool for reading circuit amperage draws and troubleshooting up to 30 amps
- Pro Kit includes one meter with 3 interchangeable test functions: 30 amp MINI circuit current testing, 30 amp ATC circuit current testing and 30 amp all purpose current test
- Plugs directly into MINI and ATC fuse sockets
- Additional 30 amp test clips expand the testing capability
- Original fuse is replaced in-line, thereby maintaining circuit protection
- Easy connection into fuse socket, Fuse Body™ end is shaped like a fuse
- LCD display features analog bar graph
- Unit also features Data Hold and Auto Power-Off
- Measuring Range: 0-30 Amps/48 VDC-10 seconds
- Accuracy: ±2% of reading
- Resolution: 100 mA

EEFB310

Order NO.: 903044

## Max Fuse Buddy®

Packing: 1



- MAXI circuit testing capability up to 80 Amps
- Also works with ATC and mini circuits-includes adapters
- Large LCD display with analog bar graph
- Unit features peak hold functions
- One touch zero function
- Amps: 0-80 Amps DC
- Resolution: 0.1A
- Accuracy: +2.0% of reading + 4 digits
- Power by: 9 volt Battery

EEFB315

Order NO.: 903046

# Shop & Technician Tools Automotive Specialty Tools

## Automatic Meter

Packing: 1

MT454C  
Order NO.: 903043



- The MT454C is a durable, easy to use compact size digital multimeter
- Include:
- Compact size fits comfortably in the palm of your hand
- Easy-to-read 4000 count digital display
- Automatically selects the correct function of DC Volts, AC Volts or Ohms (Resistance)
- Use DC Voltage ranges to verify that the proper voltage level is arriving at a sensor or circuit
- Measure ohms to determine resistance of a coil
- Also test resistance of fuses, fusible links, components and circuits
- Measure AC voltage signals on digital MAF sensors, wheel speed sensors and vehicle speed sensors
- Protective boot with tilt stand, test leads, battery and instruction manual included
- Five year limited warranty

## Meter Manual Ranging

Packing: 1

MT501C  
Order NO.: 903042



- Ergonomic, compact size fits comfortably in the palm of the hand
- Measure Ohms to determine resistance of a coil or spark plug wire
- Also test continuity of fuses, fusible links, components and circuits
- Use DC voltage ranges to verify proper voltage level is arriving at a sensor or circuit
- Large, easy-to-read, 2000 count LCD display
- Lock readings on display with data hold
- Measure AC voltage signals on digital MAF sensors plus wheel and vehicle speed sensors
- Added protection against drops and the elements with included rubber boot
- Safety cULus 3111 Listed. Meets CE and IEC 1010 safety standards
- 5 year limited warranty

## Meter Autoranging

Packing: 1

MT574C  
Order NO.: 903002



- The MT574C offers both automatic and manual ranging
- Measure Ohms to determine resistance of a coil or spark plug wire
- Use the diode function to test the diode pack on a typical alternator
- Use DC voltage ranges to verify proper voltage level is arriving at a sensor or circuit
- Large, easy-to-read, 4000 count LCD display with low battery indication
- Lock readings on display with data hold
- Measure AC voltage signals on digital MAF sensors plus wheel and vehicle speed sensors
- Measure DC current to determine presence of a parasitic load
- Added protection against drops and the elements with included rubber boot
- Safety cULus 3111 Listed. Meets CE and IEC 1010 safety standards
- 5 year limited warranty

Specifications.	MT454C	MT501C	MT574C
Display Count	4,000	2,000	4,000
AC Volts	600	600	600
DC Volts	600	600	600
Basic DC Accuracy	0.50%	0.75%	0.30%
AC Amps	—	—	400mA
DC Amps	—	—	400mA
Resistance	40M Ohm	2K Ohm	40M Ohm
Auto Range	Yes	—	Yes
Data Hold	—	Yes	Yes
Min/Max	—	—	Yes
Auto Power Off	Yes	—	Yes
CE or UL Listed	CE, cULus 3111	CE, cULus 3111	CE, cULus 3111
CAT Rating	CATIII 600 Volt	CATIII 600 Volt	CATIII 600 Volt



# Shop & Technician Tools Automotive Specialty Tools

## 5 Pin Trailer Light Tester

Packing: 1

TLT5  
Order NO.: 903047



- Easily locates electrical problems in the tow vehicle
- Checks both 4 and 5 pin flat trailer connectors with LED indicator lights
- Tests left and right signals, brake lights and running lights
- Unique and durable design allows user to leave the tester in line to continuously monitor the lighting system on the tow vehicle

## 6 Pin Trailer Light Tester

Packing: 1

TLT6  
Order NO.: 903048



- Easily locates electrical problems in the tow vehicle
- Checks 6 pin round trailer connectors with LED indicator lights
- Tests left and right signals, brake lights and running lights

## Dual 12V Trailer Plug Adaptor

Packing: 1

TLT8003  
Order NO.: 903051



- Converts 12 volt feed at the back of a truck or SUV trailer socket and to a dual 12 volt power outlet
- Powers 12 volt test equipment, charging equipment and work lights in shop environment
- Recreation purposes such as running air pumps, radios or TV's while tailgating and camping
- Dual 12 volt power supply sockets
- Plugs into any 7-way spade pin trailer connection
- Use as 12 volt feed for diagnostic equipment
- Convenient power source for accessory plug-ins
- Both shop and recreational uses
- Includes dust cover to help prevent corrosion

## Trailer Circuit

Packing: 1

TLT7  
Order NO.: 903049



- Easily locates electrical problems in the tow vehicle
- Checks 7 pin round trailer connectors with LED indicator lights
- Tests left and right signals, brake lights and running lights
- Applications include newer light trucks and SUV's

## 3 Way Trailer Adaptor

Packing: 1

TLT8000  
Order NO.: 903050



- Applications include medium/light duty trucks, 1/2 ton, 3/4 ton and 1 ton pickups, campers, and other heavy duty applications
- Adapts 7 way connection to 6 round pin and 4/5 pin connections
- Sealed plugs to keep road debris from corroding connections
- One adaptor for all your trailer needs
- Made from strong nylon 6
- Winged grip for easy installation and removal

## Gas Cap Adaptor

Packing: 1

EELDGASCAP1  
Order NO.: 903053



- Quickly pops-on virtually any filler neck
- Costly replacement seals are no longer needed
- One size fits all (new model vehicles may be subject to change)





# Shop & Technician Tools Automotive Specialty Tools

## Mini Engine Electronic Stethoscope

Packing: 1

YA6910  
Order NO.: 903054



- Sensor clamp helps to detect noises during test drives that can not be duplicated in the work bay
- Sensor tip mounted on 6" flexible shaft allows access to hard-to-reach areas
- 5" inductive metal probe allows user to pinpoint source of noise or vibration
- Ultra sensitive microphone provides a full range of sound
- Rotary volume control allows easy adjustment
- Ear-bud style earphones provide excellent sound quality

## Infrared Thermometer

Packing: 1

RTEMPB3A  
Order NO.: 903055



- Temperature range of -58° to 932°F (-20°C to 500°C)
- Use for most automotive and industrial applications requiring an infrared thermometer
- Compact size of 5.88" x 3.62" x 1.38" (149.2 x 92.1 x 34.9mm)
- Laser targeting accuracy
- Enhanced backlit 4 digit LCD for easy viewing
- Automatic power-off after 10 seconds
- Nylon holster for transport and safe storage
- Safely monitor hot, hazardous, or hard to reach materials without contamination or damage to the surface
- Simply point at target, pull the trigger, and read the temperature on the large, backlit LCD display

## Probe, Coil-On-Plug

Packing: 1

YA76562  
Order NO.: 903052



- Super bright KV & ARC indicator LEDs
- 7" signal receiver probe
- Battery operated
- Sensitivity thumb-wheel

## Universal EFI Quick Probe

Packing: 1

YA76462  
Order NO.: 903058



- Quickly detects electronic fuel injector functions on any gas or diesel engine
- Specifically designed to detect the vibrations emitted when the electronic injector fires
- No hunting for injector wires to test at the connector
- No need to remove the injector for testing
- Super bright LED strobe
- 7" removable probe tip
- Battery operation
- Sensitivity thumb wheel

## Terminal Tool Kit

Packing: 1

TT12KT  
Order NO.: 903057



- Applications include most GM and other domestic computer connectors and terminals. Individual handles for easy access in tight places. Designed for weather pack and pack-con terminals with flat blade to open connectors and fork for ALDL connectors to access trouble codes. Color coded: Red handle for GM and Green for wire terminal tools. Includes storage case
- Kit includes these GM C3 System Terminal Tools (red handle):
  - Tube, Spring Loaded, 3.3mm x 28mm
  - Square Blade, 1.4 x 19.00mm
  - Flat Blade, 1.5 x 24.75mm
  - Flat Blade, 2.0 x 23.00mm
  - Fork Blade, 8.0 x 24.00mm
  - Flat Blade Screwdriver, 3/16" x 1.00"
- Kit includes these Wire Terminal Tools (green handle):
  - Tube, 3.30 x 28.0mm
  - Tube, 4.30 x 13.0mm
  - Tube, 3.75 x 13.0mm
  - Tube, 3.00 x 13.0mm
  - Flat Twin Blade, 3.0mm
  - Flat Twin Blade, 1.6mm



# Shop & Technician Tools Automotive Specialty Tools

## Line Clamp Set

Packing: 1

HCP3KT

Order NO.: 903005



- HCP6A, HCP7A and HCP10A (6", 7", 10") in storage pouch
- **HCP6A Hose Pinching Pliers**
  - For sealing hose sizes 1/8" to 5/16"
  - Also use on brake lines, fuel lines and vacuum hoses
  - 6" long
- **HCP7A Hose Pinching Pliers**
  - For sealing hose sizes 1/2" to 3/4"
  - Also use on heater hoses and vacuum lines
  - 7" long
- **HCP10A Hose Pinching Pliers**
  - For sealing hose sizes 3/4" to 2 1/4"
  - Also use on radiator hoses
  - 10" long

## Portable Booster Pack

Packing: 1

EECS1AP

Order NO.: 903151



- Starting current: 660AMP
- Peak current: 1200AMP
- 12V/22AH Sealed Lead-acid batteries
- With 12VDC 15A cigarette lighter socket
- Automatic circuit overload protection
- 100% Copper 4GA Heavy Duty Jump Cable

## Master Plus Disconnect Set

Packing: 1

LDT14

Order NO.: 903006



- LDT14 contains all tools from the popular LDT8, Master Disconnect Set; in addition the kit has:
  - The two most popular Jiffy-tite Disconnect tools
  - The new blue 5/16" fuel line adapter
  - A set of 4 air line push-pull disconnect tools that work on heavy duty trucks and industrial applications
  - Label inside cover of carrying case shows images and applications

## Master Line Disconnect Set

Packing: 1

LDT8

Order NO.: 903059



- A complete set of disconnect tools for spring lock and quick disconnect couplings used on air conditioning and fuel lines on Ford, GM and Chrysler vehicles
- Includes a set of six standard disconnect tools (5/16", 3/8", 1/2", 5/8", 3/4" and 7/8") and six color coded, angled disconnect tools for use in tight spots
- **SPECIALIZED GM APPLICATIONS:**
  - Includes tools for use on GM 3/8" flex fuel capable fuel filter removal plus 5/16" and 3/8" GM fuel modules
- **SPECIALIZED FORD APPLICATIONS:**
  - Includes tools for use on 3/8" and 1/2" Ford transmission and cooler lines with stepped line plus 5/16" x 3/8" scissor disconnect and Ford coupler disconnect tools

## Battery System Tester

Packing: 1

YA2612B

Order NO.: 903061



- No conversion tables needed for CCA, SAE, IEC, EN, or Ah
- Battery condition is shown in % of capacity
- Uses conductance technology
- Tests 12V starting/charging systems
- Tests both flooded lead acid and AGM batteries
- Multi-colored bar graph displays battery condition
- Low voltage indicator LED lights when charging is necessary
- Bad cell is detected and displayed
- Comfortable grip with easy to use clamps
- Tests discharged batteries
- Patented circuitry
- Reverse polarity protection
- Made in USA

## Terminal Brush

Packing: 1

BTC3A

Order NO.: 903063



- Stiff wire bristles thoroughly clean posts and clamps
- 3 3/8" long

# Shop & Technician Tools Automotive Specialty Tools

## Battery Carrier

Packing: 1



- For top post and side terminal batteries
- Rubber pads securely grip battery widths from 5" to 7"
- Plastic hand grip provides a firm hold

BL1B

Order NO.: 903064

## UV Leak Detection Flashlight Kit

Packing: 1



- High intensity LED bulb with 100,000 hour service life
- Over four hours of peak performance per charge
- Power comparable to high intensity 75 watt lamps
- Compatible with all standard leak detection dyes
- Inspection range of up to 6'
- Three "AAA" batteries and fluorescence enhancing glasses are included

ECFUVLITE

Order NO.: 903068

## Manifold Repair Kit

Packing: 1



- Includes various replacement lens, knobs, O-rings, gaskets and more
- Kit components are used to service ACTR41511

ACT1234PKT

Order NO.: 903065

## Replacement Hose (R12)



Stock No.		Order No.
ACTB72	1	903069
ACTY72	1	903078

### ACTB72

- 1/4 turn manual shutoff valves
- Blue, 6' length

### ACTY72

- 1/4 turn manual shutoff valves
- Yellow, 6' length

## Manifold Set

Packing: 1



- Anti-flutter gauges smooth out needle movement
- Easy grip all metal side mounted knobs
- Piston type free floating valves reduce O-ring wear
- Manual R134a couplers
- Gauges can be recalibrated to maintain accuracy
- 60" inner nylon layer hoses meet EPA, SAE, and UL standards
- Yellow hose includes shut off valve

ACTR4131A

Order NO.: 903066

## Replacement Hose (R12)



Stock No.		Order No.
ACTB72A	1	903070
ACTY72A	1	903079

### ACTB72A

- Automatic shutoff valves
- Blue, 6' length

### ACTY72A

- Automatic shutoff valves
- Yellow, 6' length



# Shop & Technician Tools Automotive Specialty Tools

## Replacement Hose (R134a)



Stock No.		Order No.
ACTRB72	1	903072
ACTRR72	1	903074
ACTRY72	1	903076

- Low permeation hoses for internal equipment connections

### ACTRB72

- Blue, 6' length

### ACTRR72

- Red, 6' length

### ACTRY72

- Yellow, 6' length

## Replacement Hose (R134a)



Stock No.		Order No.
ACTRB96	1	903073
ACTRR96	1	903075
ACTRY96	1	903077

- Low permeation hoses for internal equipment connections

### ACTRB96

- Blue, 8' length

### ACTRR96

- Red, 8' length

### ACTRY96

- Yellow, 8' length

## Manual A/C Hose Crimper

Packing: 1

ACTMAN2100  
Order NO.: 903071



- Unit is easily mounted to bench with holding fixture or held securely in a vise
- Includes a complete set of dies covering standard #6, #8, #10 and #12 hose sizes
- Includes storage case

## Thermometer

Packing: 1

ACT73A  
Order NO.: 903080



- Range 0° F to 220° F (-18° C to 105° C) in 2° increments
- Checks temperature of condenser, outside air, and cooling power

## Dial Type Thermometer

Packing: 1

ACT83A  
Order NO.: 903081



- Range 0° F to 220° F in 2° increments
- Storage case
- Stem should be immersed about 2" in liquids, 4" in gases

## Pocket Digital Thermometer

Packing: 1

TEMP10  
Order NO.: 903082



- Measures liquid, air and surface temperatures via sturdy stainless steel probe
- Digital display for easy viewing
- Angle viewing head can be lifted and rotated 180° for a different viewing angle
- Convertible from Fahrenheit (F) to Centigrade (C) temperature ranges
- The -58° F to 300° F (-50° C to 150° C) temperature range enables use on a wide range of applications
- Tactile on/off button for easy operator use (auto off function extends battery life)
- Tactile data hold button holds the reading when the display cannot be seen
- Temperature range noted on bevel
- Plastic carrying sheath protects the user when carried in shirt pocket

## Fin Straightener & Cleaner

Packing: 1

ACT407  
Order NO.: 903083



- Multi-head tool handles 8, 9, 10, 12, 14, and 15 fins per inch
- 4 1/4" long

# Shop & Technician Tools Automotive Specialty Tools

## Spanner Wrench

Packing: 1



- Adjustable three stud design for GM R-4 compressors
- Also has applications on some GM, Warner, Pitts, and Ogura clutches

ACT499A  
Order NO.: 903084

## Orifice Tube Remover

Packing: 1



- Use as CCOT and FFOT screen extractor
- Use in conjunction with ACT106B
- Manual shut-off valves

ACT1009A  
Order NO.: 903087

## Core Service Tool

Packing: 1



- Use on R12/R134a standard valve cores and JRA/EATON large bore R134a valve cores

ACT81290  
Order NO.: 903085

## Flush Kit

Packing: 1



- Provides pressure flushing of condensers, evaporators, and refrigerant lines after the A/C system is completely discharged
- Designed to work with any lightweight flushing material that can be mixed with pressurized air
- Includes flush gun, hose, canister, and canister adaptor

ACT1046C  
Order NO.: 903088

## Orifice Tube Tool

Packing: 1



- Services A/C systems
- 6 1/4" long
- Manual shut-off valves

ACT1008A  
Order NO.: 903086

## Spring Lock Coupler Set

Packing: 1



- 4 pc. set aids in disconnecting refrigerant line couplings on many 1981 and later Ford A/C systems
- Color coded:
  - Red, 3/8"
  - Blue, 1/2"
  - Black, 5/8"
  - Beige, 3/4"

ACT118B  
Order NO.: 903091

## Expansion Tube Remover

Packing: 1



- For most GM models
- 4" long
- Manual shut-off valves

ACT106B  
Order NO.: 903089

# Shop & Technician Tools Automotive Specialty Tools

## Oil Injector Adaptor

Packing: 1



- Has an aluminum body and holds up to 2 oz. of oil
- Uses pressure differential of the high and low side of A/C system

ACT111B  
Order NO.: 903090

## Universal Valve Core Service Tool

Packing: 1



- Removes and replaces standard size Schrader style valve cores plus the larger size found in GM systems

ACT1290A  
Order NO.: 903093

## Quick Connect Set

Packing: 1



- Simplifies connecting to core valve service fittings
- Includes both a straight coupler and a 90° coupler that accept either of two adaptors (one for low side, one for high side)
- Manual shut-off valves

ACT119  
Order NO.: 903092

## Disconnect Set

Packing: 1



- Set includes six tools for disconnecting spring couplings on fuel lines
- Convenient plastic holder included
- Also useful on A/C spring couplings as well as push lock connectors on radiator and transmission lines
- Includes six tools for disconnecting spring couplings on Ford, GM, and Chrysler A/C lines
- Works on fuel lines and can be used as push lock connectors on radiator and transmission lines
- Included sizes are 5/16", 3/8", 1/2", 5/8", 3/4" and 7/8"

ACT1370  
Order NO.: 903004

## Gas/Diesel Combustion Leak Tester

Packing: 1



- Provides an easy and quick way to diagnose engine overheating problems
- Checks for leaks between the combustion chamber and the cooling system
- Test head and gasket for combustion leaks before removing the radiator
- Double chamber in testing unit provides a high level of accuracy
- For use on water cooled gas and diesel engines
- Kit includes complete test chamber, 16 oz. bottle of testing fluid and instructions

GDCT16  
Order NO.: 903095

## Cooling System Adaptor Set

Packing: 1



- TAB Series Adaptors feature a composite metal/plastic construction for a lower cost option
- Set includes 14 radiator composite metal/plastic radiator adaptors
- Includes all TAB Series Adaptors plus TA4503 Adaptor
- PBSVTA1417 Storage Case has a removable cover for display purposes

SVTAB1400  
Order NO.: 903096



# Shop & Technician Tools Automotive Specialty Tools

## Leverage Hose Cutter

Packing: 1



- (8 1/2") Compound action multiplies normal hand pressure to easily slice through many types of rubber and plastic hose up to 1 1/8" in diameter
- Includes stainless steel cutter blades and internal components

PWC60

Order NO.: 903097

## Fan Clutch Pulley Holder

Packing: 1



- Removes and replaces the fan clutch on vehicles using "bolt on" water pump pulleys
- Reverse pulley holder for assembly operations
- Use with YA9521 36/48mm wrench or YA9526 40mm wrench for many Chrysler, Ford, Lincoln, Mercury and GM applications

YA6160

Order NO.: 903099

## Antifreeze Hydrometer

Packing: 1



- Degree of protection is indicated by direct reading-no temperature compensating scales are required
- Range of +32°F to -60°F
- Includes Celsius scale
- Tests hot and cold solutions

AF102

Order NO.: 903094

## Tire Gauge and Inflator

Packing: 1



- Measures from 5 to 150 PSI
- Displays reading in psi, bar, kPa or kg/m<sup>2</sup>
- 1/4" NPT fitting for inlet air connection
- Shock proof rubber guard helps prevent damage if dropped
- On/Off button for display light
- Clip on air chuck
- Batteries included

TPGDL1000A

Order NO.: 903101

## Cooling System Pressure Tester

Packing: 1



- Inflatable bladder sealing system enables use with most passenger and light commercial vehicles
- Tests header tanks and radiator systems as well as thread type and bayonet-style caps
- Locate leaks from head gaskets, radiator and heater cores, Welch plugs and housings, water pumps and hoses
- Test cap relief pressure and seal condition
- Suitable for marine applications
- Fluid drain tube allows coolant to be returned to reservoir or safely collected for recycling
- Bladders are cycle tested to over 1,500 inflations

SVT275

Order NO.: 903098

## Dial Tire Inflator / Gauge

Packing: 1



- 1% accuracy allows for use on vehicles equipped with TPMS sensors
- Shorter hose and body length make this gauge ideal for use on cars and light trucks
- Rugged dial and plunger style mechanism preserve gauge accuracy when dropped
- Stainless Steel Braided Hose
- 6-160 PSI, 60-1100kPa

TIF160

Order NO.: 903153

# Shop & Technician Tools Automotive Specialty Tools

## Pressure Gauge

Packing: 1

TPGIF1600  
Order NO.: 903102



- 10 to 120 PSI in 2 pound increments 1/4"
- 1/4" FNPT air inlet fitting
- Swiveling hose for easy gauge positioning
- Zinc body with heavy duty brass valves
- Easy to read sight glass featuring PSI and kPa readings

## Tread Depth Gauge

Packing: 1

GA599A  
Order NO.: 903100



- Measures to a depth of 1" in 1/32" increments
- Plastic body with aluminum probe and sliding gauge
- Includes pocket clip

## Pressure Gauge

Packing: 1

TPGP120  
Order NO.: 903103



- Calibrated in 2 psi increments from 20 to 150 PSI and in 10 kPa increments from 150 to 800 kPa
- Chrome plated
- 5 3/4" long

## Valve Stem Inserter

Packing: 1

VT1A  
Order NO.: 903001



- Simplify installation of valve stem in tubeless tire rim
- Shank is notched to accommodate various rim styles
- Has a comfortable, screwdriver type handle
- 12" long

## Universal Valve Core Tool

Packing: 1

VT14  
Order NO.: 903104



- Double ended wrench removes and installs large and small valve cores
- Reverse the double ended wrench in the tool body to fit both large and small valve cores
- Use the cup end to remove valve caps
- Valve Stem Inserters
- Simplify installation of valve stem in tubeless tire rim
- Shank is notched to accommodate various rim styles
- Has a comfortable, screwdriver type handle
- 12" long

## 1/2" Torque Stick Set, 5 pcs

Packing: 1

BTQS500  
Order NO.: 903105



- Entry level set covers the most popular models
- Size ranges from 19 to 22mm
- Torque range from 80 to 147 ft. lbs
- 1/2" drive
- Includes BTQS12B, BTQS12BB, BTQS12C, BTQS12EE and BTQ12SI (5 pcs) in BTQSCASE storage case



# Shop & Technician Tools Automotive Specialty Tools

## 1/2" Torque Stick Set, 6 pcs

Packing: 1



- Set contains sticks to compliment the BTQS1000 set to cover any applications you may still have
- Size ranges from 17 to 22mm
- Torque range from 55 to 113 ft. lbs
- 1/2" drive
- Includes BTQS12AA, BTQS12F, BTQS12G, BTQS12H, BTQS12K and BTQS12MM (6 pcs) in BTQSCASE storage case

BTQS600  
Order NO.: 903106

## Inner Tie Rod Tool

Packing: 1



- Designed to remove tie rods lacking a full hex on the socket end
- Removable crowfoot adaptors are placed on hex of tie rod
- Tool then engages crowfoot for removal or installation of tie rod
- Includes crowfoot adaptors in 1 3/16", 1 1/4", 1 5/16", 1 7/16", 1 1/2" and 33.6mm sizes

YA3000C  
Order NO.: 903110

## 1/2" Torque Stick Set, 10 pcs

Packing: 1



- Master set covers the majority of domestic and foreign cars and light trucks
- Size ranges from 19 to 24mm
- Torque range from 80 to 160 ft. lbs
- 1/2" drive
- Includes BTQS12A, BTQS12B, BTQS12BB, BTQS12C, BTQS12E, BTQS12EE, BTQS12I, BTQS12T, BTQS12XX and BTQS12Y (10 pcs) in BTQSCASE storage case

BTQS1000  
Order NO.: 903107

## Inner Tie Rod Tool

Packing: 1



- Use on inner tie rods with inaccessible wrench flats found on many trucks and SUV's
- Large inner tie rod tool includes 4 crowsfoot wrenches: 1 7/16", 33.6mm, 38.4mm and 42mm
- The long socket slips over the tie rod end and the crowsfoot engages on socket for easy removal and installation
- Applications include many Toyota, Nissan, Ford, Lincoln Mercury and Chevrolet truck and SUV's
- Also fits some Cadillac Escalade, Hummer H2, Honda Passport and Jeep Liberty

YA3100  
Order NO.: 903111

## Wheel Lock Kit

Packing: 1



- Wheel Lock Removal Socket Set
- Easily removes most lug nuts and wheel locks on most domestic and import passenger vehicles and light trucks
- Use with hand driver or impact wrench
- Some sockets cover specific GM, Ford and Chrysler applications
- Set includes 11 sockets, extension and extractor punch in storage case

LSR1000A  
Order NO.: 903108

## Inner Tie Rod Tool

Packing: 1



- Removes inner tie rods equipped with completely round end sockets or flats
- Designed to remove and install all inner tie rod sockets up to 1 31/64"
- Wrench head has 3 set screws that tighten against the socket
- Includes 1/4" short head hex wrench

YA3500  
Order NO.: 903109

# Shop & Technician Tools Automotive Specialty Tools

## Master MacPherson Strut Tool

Packing: 1

MSC1  
Order NO.: 903007



- Designed to quickly and easily compress most MacPherson strut springs
- Compresses up to 5/8" (.625mm) coil diameter
- Broad spring contact for stable compression
- Acme threaded rod and built in detent latches to help lock coil in place
- Forged construction for strength and durability

## Coil Spring Compressor

Packing: 1

MSC2  
Order NO.: 903112



- Removes and installs coil springs quickly and safely
- Compresses coil springs on all passenger cars and pick up trucks
- Features Acme threaded rod

## Cam Lock Tool Set

Packing: 1

ML6000COMBO  
Order NO.: 903118



- Includes (4) CC100 Single Cam Clamps and (1) ML6000 Dual Cam Clamp in storage tray
- Single cam clamp can be used on engines where the dual clamp will not fit
- Compact design permits easy operation in confined engine areas
- Simple and easy to use
- Manufactured from high strength industrial polymers which will not corrode or damage engine pulleys
- Dual cam clamp prevent engine damage resulting from incorrect timing
- Maintain valve timing during belt replacement on twin and quad cam engines
- Compact design allows access in transverse engines
- Fits timing gear diameters from approximately 4" (101mm) to 6" (152mm)
- Fits gear spacing from approximately 0.06" (1.6mm) to 3" (76mm)

## Manual Fluid Dispenser

Packing: 1

VAC201  
Order NO.: 903113



- Easily remove engine oil, gear and transmission oil, coolant and brake fluids
- Unit creates vacuum or pressure providing a clean, fast and simple way to evacuate or dispense a wide range of fluids
- Automatic shut off prevents the overflow of the reservoir tank with shut off at 8 liters
- 2.3 gallon (8.8 liter) total capacity
- Durable polyethylene construction is impervious to automotive and house hold chemicals
- No electrical or compressed air required
- Sturdy base with exterior pump helps prevent evacuator from tipping
- Complete system includes manual fluid evacuator, main hose assembly (5/16" ID x 54" long) plus two rigid dipstick tubes for engine oil removal (3/16" ID x 34" and 1/8" ID x 34")

## Strap Wrench

Packing: 1

A91E  
Order NO.: 903114



- Use on large diameter oil filters 1 to 6"
- Includes both 3/8" and 1/2" square drives

## Oil Filter Pliers, Adjustable

Packing: 1

YA4274  
Order NO.: 903008



- Use on filters from 2 1/2" to 5 1/4" diameters
- Use on automotive and truck applications
- Spring action size adjustment assures a solid grip on filter
- Offset handle offers increased accessibility
- Heavy duty forged levers
- Cushioned grips for comfort
- Industrial black finish with blue grips
- Overall length of 13 1/2"

# Shop & Technician Tools Automotive Specialty Tools

## Oil Filter Pliers, Extra Large

Packing: 1



YA4275

Order NO.: 903115

- Use on filters from 4 1/4" to 7" (108-178mm) diameters
- Applications include truck, tractor and high torque diesel engines
- Spring action size adjustment assures a solid grip on filter
- Offset handle offers increased accessibility
- Heavy duty forged levers
- Cushioned grips for comfort
- Industrial black finish with blue grips
- Overall length of 19" (482.6mm)

## Oil Filter Wrenches

Packing: 1

Order NO.: 903108



Stock No.	Size (mm)	Steps	Flats	Style		Order No.
FW656714A	65, 67	2	14	Cup	1	903009
FW757715A	75, 77	2	15	Cup	1	903010
FW7630A	76	1	30	Cup	1	903011
FWA62121A	62, 121	—	—	Adjustable	1	903012

Stock No.	Square Drive (inches)	Application
FW656714A	3/8	Fram-PH4386, PH4967, PH6017, PH6018, PH6607
FW757715A	3/8	NAPA, AC Delco, Castrol, STP, Penske
FW7630A	3/8	Fram, IAPCO, Motorcraft, Parts Plus, Pennzoil
FWA62121A	3/8	Adjustable filter wrench for 62 to 121mm diameter oil filters, 3/4" external hex

## Funnel

Packing: 1

FUNN15

Order NO.: 903116



- High visibility red funnel for large neck fillers
- Both ends of the funnel have screw on caps to contain fluids if needed
- 1.5 qt. capacity

## Oil Filter Wrench Set, 7 pcs

Packing: 1

FWK7A

Order NO.: 903013



- Wrenches in set cover 95% of domestic and import automobile and light truck oil filters
- Storage/carrying case keeps wrenches together for quick access and contains any oil residue keeping it out of your tool storage unit
- Includes laminated application chart
- FWK7A set includes FW656714A, FW757715A, FW7614A, FW7630A, FW8015, FW9315A and FWA62121A oil filter wrenches

## Grease Gun

Packing: 1

GA472

Order NO.: 903014



Specification	PSI	Nozzle
Pistol Grip	5,000	13 1/4"
Capacity	Flexible Hose	Rigid Extension
14 oz.	—	3 1/2"
Loading		
Bulk, Cartridge, or Filler Pump		

- Standard series grease guns
- All are steel with zinc plating
- Inner-spring chamber can be either cartridge or bulk loaded

## Grease Gun, Lever

Packing: 1

YA728A

Order NO.: 903022



Specification	PSI	Nozzle
Lever	6,000	—
Capacity	Flexible Hose	Rigid Extension
16 oz. Bulk and 14 1/4 oz. Cartridge	18"	6"
Loading		
Bulk or Cartridge		

- Lever operated, large capacity gun accepts 16 oz. bulk or 14 1/4 oz. cartridge grease
- Develops 6,000 PSI
- Includes tough, 18" flexible whip hose with coupler and 6" rigid extension



# Shop & Technician Tools Automotive Specialty Tools

## Grease Gun, Pistol

Packing: 1

YA734A

Order NO.: 903017



Specification	PSI	Nozzle
Pistol Grip	6,000	—
Capacity	Flexible Hose	Rigid Extension
16 oz. Bulk and 14 1/2 oz. Cartridge	18"	6"
Loading		
Bulk or Cartridge		

- Develops 6,000 PSI maximum pressure
- Pistol grip unit features suction, cartridge, or filler pump loading
- Includes flip over follower, 18" flexible hose, 6" rigid extension and hydraulic coupler

## Grease Gun, Air

Packing: 1

YA772B

Order NO.: 903016



PSI	Air Operating PSI	Pump Ratio
4,000	60 - 150	40:1
Capacity	Flexible Hose	Rigid Extension
14 oz. Cartridge	18"	6"
Loading		Nozzle
Bulk, Filler Pump, or Cartridge		—

- Automatic operation provides continuous grease flow with trigger depressed
- Pumps at a 40:1 ratio with a maximum pressure of 6,000 PSI
- Use with standard 14 oz. cartridge, bulk fill or filler tube
- Heavy duty 18" flexible nylon hose improves accessibility and reach
- Air vent allows easy removal of trapped air after loading grease tube
- Light weight of 3.52 lbs
- Helps reduce operator fatigue

## Accessory Pack, Grease-dispensing

Packing: 1

YA7500

Order NO.: 903015



- Includes 10 pcs. as follows in a storage tray
  - Universal swivel
  - Needle nozzle coupler
  - Flex whip hose 12"
  - Flex whip hose 18" (for manual grease guns)
  - Flex whip hose 18" (for powered grease guns)
  - Heavy duty coupler
  - Swivel coupler
  - Coupler
  - Coupler extension
  - Angle lube adaptor

## 12" Hose

Packing: 1

YA751

Order NO.: 903019



- For powered and hand operated grease guns
- 1/8" NPT(m) both ends
- 4,500 maximum PSI
- 12" long

## 18" Hose

Packing: 1

YA752

Order NO.: 903020



- 18" long version of YA751

## Nozzle, Needle

Packing: 1

YA750

Order NO.: 903018



- 1/8" NPT(f.) thread
- 2 3/4" long

## Adaptor, Needle Type

Packing: 1

YA801

Order NO.: 903021



- For universal joint fittings, water pumps, and metal covered springs
- 4 7/8" long

## Oil Suction Gun

Packing: 1

YA745A

Order NO.: 903117



- 16 oz. capacity
- Fast, clean method for removing or adding transmission and gear oil
- Special follower is impervious to oil, grease, and water
- Flexible nozzle

# Shop & Technician Tools Automotive Specialty Tools

## Serpentine Belt Tool Kit

Packing: 1



YA9350B

Order NO.: 903119

- Hex Applications
  - YA9350-6 (13mm or 1/2") - GM "Quad 4" 2.3L and Volkswagen 2.0L
  - YA9350-2 (14mm) - Isuzu 3.1L, Lexus (2.5L, 3.0L, 4.0), Mazda (2.3L, 3.0L, 4.0L), Saturn 1.9L with 4mm hex on idler pulley, Toyota 3.0L, Volkswagen (1.8L, 2.5L, 2.8L)
  - YA9350-8 (15mm) - GM 2.2L, Isuzu 2.8L, Jeep 4.7L
  - YA9350-7 (16mm or 5/8") - Ford/Lincoln/Mercury (2.3L, 3.8L, 4.0L, 4.9L, 5.0L, 5.8L), GM (4.3L, 5.0L, 5.7L)
  - YA9350-3 (18mm) - GM (2.0L, 3.1L, 3.3L, 3.4L, 3.8L)
  - YA9350-9 (19mm or 3/4") - Mercedes (use with 15mm adapter for extra reach), Toyota (1.8L, 2.4L)

Wrench Only - Dodge/Chrysler/Plymouth (3.0L, 3.3L, 3.9L) (has 15mm drive), Ford/Lincoln/Mercury (2.3L, 3.0L, 3.8L)

- Square Applications
  - YA9350-4 (3/8") - Ford/Lincoln/Mercury (1.9L, 2.3L, 2.5L, 4.0L), GM (2.0L, 2.2L, 2.8L, 3.1L, 3.4L), Isuzu (2.8L, 3.1L)
  - YA9350-5 (1/2") - Dodge/Chrysler/Plymouth (2.0L, 3.0L), Ford/Lincoln/Mercury (2.3L, 3.0L, 4.2L, 4.6L)

## Serpentine Belt Tool

Packing: 1



SBT26

Order NO.: 903120

- Works on all serpentine belts
- Clamping jaw allows user to position serpentine belt without the belt slipping out of the tool
- Positive grip allows belt routing in tight access areas that would normally be difficult to reach
- Ergonomic handle provides comfort and ease in use, acting as an extension of the user's hand
- Lightweight steel body for durability and strength

## Valve Spring Compressor

Packing: 1



CF700B

Order NO.: 903121

- 7/8" to 2 1/2" capacity
- Operates on 90 PSI to 150 PSI, but develops up to 3 times output pressure
- Tool measures 1" x 8"

## C-Clamp Compressor

Packing: 1



CF811B

Order NO.: 903122

- 1" to 2" capacity
- For "L" head, valve-in-head, high compression engines and vehicles with overhead valves
- Activating mechanism prevents cocking of valve spring as it is compressed

## C-Clamp Compressor

Packing: 1



CF19B

Order NO.: 903123

- This compact model includes CF19-3A Jaws for 1/4" to 1 1/16" diameter springs on small, air cooled engines and CF19A5 Jaws for both 17mm and 20.8mm diameter springs on Honda engines

## Brake Bleeding Kit

Packing: 1



BB500

Order NO.: 903028

- Kit includes BB5001 Vacuum Brake Bleeder and BB5002 Auto Refiller Bottle

### BB5001 Vacuum Brake Bleeder:

- Large 3-pint (1.5 liter) container
- Generates 25 in Hg vacuum with air pressure of 100 psi
- On/OFF valve and flow regulator
- Quick release locking trigger, safety shut off valve and overfill check valve
- Compact design fits under wheel well
- 19.5" (500mm) suction hose
- Universal brake screw fitting

### BB5002 Auto Refiller Bottle:

- 20 fluid oz (592 ml) container
- Automatically keeps the reservoir filled to the correct level
- Retaining clip for positive attachment
- Compact design fits under hood
- Positive venting system supplies continuous flow
- Unit can be sealed when not in use to prevent spillage



# Shop & Technician Tools Automotive Specialty Tools

## Air Adjusting Valve, with Gauge

Packing: 1



BF555

Order NO.: 903145

- Designed for use with HVLP spray guns
- Includes 160 PSI pressure gauge
- Air Inlet: 1/4" M.P.T
- Air Outlet: 1/4" F.P.T. (swivel nut)

## Seal Pliers

Packing: 1



YA8230

Order NO.: 903023

- Removes valve stem seals from overhead camshaft engines including 4 valve per cylinder engines that have restricted access to the valve stem seal due to the head design
- Gripping serrations in the pliers tip easily grab both OEM and aftermarket seals with ease
- Easy grip handles

## Ring Compressor Set

Packing: 1



RC980

Order NO.: 903124

- Works both horizontally and vertically with pliers grip handle
- Has a fine tooth ratcheting mechanism
- Includes 6 hardened steel bands: 2 7/8" to 3 1/8", 3 1/8" to 3 3/8", 3 3/8" to 3 5/8", 3 5/8" to 3 7/8", 3 7/8" to 4 1/8", and 4 1/8" to 4 3/8"

## Bearing Race and Seal Driver Set

Packing: 1



A1310A

Order NO.: 903125

- Collars fit most standard wheel bearing sizes
- The three largest sizes fit most late model 4 wheel drive vehicles

## Ring Compressors



Stock No.	Band	Capacity (inches)	Deep (inches)	Order No.
RC40C	2	2 1/8 to 5	3 1/2	1 903024
RC50C	2	3 1/2 to 7	3 1/2	1 903025

- Clutch control holds tension band in position as piston is inserted into cylinder
- 1/2" wide spring bands equalize tension over belt width so ring assembly may be compressed into groove until flush with piston
- "V" beads on lower edge of belt keep tool from entering cylinder
- RC40C can be used upside down for Chevrolet, Mercury, and Ford trucks with angled blocks

## Rotor Micrometer

Packing: 1



RM130

Order NO.: 903030

- Range of .30" to 1.3" in .0001" graduations
- 3.5" deep frame
- Pointed anvil for checking grooves
- Includes 1" checking standard and storage case

## Oval Tube Creeper

Packing: 1



Pad Color	Overall Size (inches)	Pad Length (inches)
Black	40 (L) x 17 (W) x 4 (H)	39
Pad Width (inches)	Number of Casters	Caster Diameter (inches)
11	4	2 1/2

JCW8A

Order NO.: 903126

- 40" long creeper is constructed of 16 ga. steel and has a unique drop in the shoulder area to provide for generous shoulder clearance; low 3/4" ground clearance
- Fully padded with heavy duty foam for durability; pad measures 1 3/4" thick, headrest pad measures 2 3/4" thick covered with heavy duty vinyl
- Four 2 1/2" oil resistant, full ball bearing casters
- Weight is 18 lbs

# Shop & Technician Tools Automotive Specialty Tools

## Brake Spring Tool

Packing: 1

BT9

Order NO.: 903127



- Quickly and easily removes or replaces springs
- Allows mechanics to press spring into place with one simple motion, taking the place of the slide mechanism
- Includes two mechanisms to allow easy removal and replacement of springs on brakes
- Patent pending
- 8 3/4" long

## Air Riveter

Packing: 1

HP301C

Order NO.: 903133



Recommended Air Pressure (psi)	Air Consumption, average cfm (scfm) [l/min]
85-95	—
Air Inlet Thread Size	Traction Power (lbs)
1/2" NPT	3,300
Stroke	Weight (kg.)
5/8" (15.8 mm)	3.0

- Sets structural rivets, KLIK-FAST® rivets from 5/32" to 1/4" diameter in all alloys plus KLIK-SPLIT® / Monobolt rivets from 3/16" to 1/4"
- Includes 5/32", 3/16" and 1/4" nosepieces plus mandrel collection bottle

## Brake Caliper Kit, 7pcs

Packing: 1

YA8610B

Order NO.: 903033



- Assists in replacement of brake pads on most 4-wheel disc brake cars
- Tool and adaptors position brake piston back into caliper to allow clearance for newer, thicker brake pads
- Designed for most Audi, Chrysler Corporation, Ford, GM, Honda, Jaguar, Mazda, Mini Cooper, Mitsubishi, Nissan, Saturn, Subaru, Toyota, Volkswagen and Volvo
- Set includes one tool and seven adaptors in a storage case

## Brake Caliper Press

Packing: 1

BTCP1

Order NO.: 903032



- Works on both fixed and floating calipers
- Generates more than 1600 ft. lbs. of force to retract the toughest caliper pistons
- Single lever mechanism used to apply and release force for ease of operation and faster service
- Prevents damage to pistons, hubs or calipers
- Ensures parallel piston retraction on dual and quad piston calipers
- Easy left and right side use

## Throttle Depressor

Packing: 1

B240B

Order NO.: 903131



- Holds throttle at a constant RPM
- Easily adjusts to desired length
- Adjustment screw fine tunes desired RPM
- Rubber tip keeps the tool firmly positioned on the accelerator pedal
- Overall length of 40" (102cm)
- Can also be used as a pedal depressor

## Brake Gauge Set

Packing: 1

BTG8

Order NO.: 903130



- Color coded gauges provide instant feedback on brake pad/shoe condition
- Constructed from 20 gauge sheet metal with durable powder coat finish
- Pad/shoe condition is indicated with color by the respective testing gauge
- Red indicates service required, yellow indicates caution and green indicates an OK situation
- Set includes 8 different testing blades of various colors and thickness
  - Red 2mm (0.0787")
  - Red 3mm (0.1181")
  - Yellow 4mm (0.1575")
  - Yellow 5mm (0.1969")
  - Yellow 6mm (0.2362")
  - Green 8mm (0.3150")
  - Green 10mm (0.3937")
  - Green 12mm (0.4724")

# Shop & Technician Tools Automotive Specialty Tools

## HVLP Spray Gun



Stock No.	BLP13HVLP	BLP14HVLP	BLP15HVLP	BLP18HVLP
Fluid Tip (mm)	1.3	1.4	1.5	1.8
Air Consumption (scf m)	9.5	9.5	9.5	9.5
Max. Inlet HVLP psi (bar, kPa)	29 (2.0, 20.0)	29 (2.0, 20.0)	29 (2.0, 20.0)	29 (2.0, 20.0)
Dry Weight without Cup, oz. (grams)	12.6 (359)	12.6 (359)	12.6 (359)	12.6 (359)
Air Inlet Thread Size	1/4" NPSM	1/4" NPSM	1/4" NPSM	1/4" NPSM
Cup Size (cc)	600	600	600	600
Application	High solids, colors and clears	High solids, colors and clears	Medium solids, colors and clears	Primer, high viscosity materials
Order No.	903140	903142	903143	903144

## 1.0 Mini HVLP Spray Gun

Packing: 1



Fluid Tip (mm)	Air Consumption (scfm)	
1.0	7.0	
Max. Inlet HVLP psi (bar, kPa)	Dry Weight without Cup, oz. (grams)	
29 (20, 200)	11.4 (322)	
Air Inlet Thread Size	Cup Size (cc)	Application
1/4" NPSM	125	Primer, base and clear

BLP10MHVLP  
Order NO.: 903139

## 1.4 Conventional Spray Gun

Packing: 1



Fluid Tip (mm)	Air Consumption (scfm)	
1.4	9.5	
Max. Inlet HVLP psi (bar, kPa)	Dry Weight with out Cup, oz. (grams)	
—	12.6 (359)	
Air Inlet Thread Size	Cup Size (cc)	Application
1/4" NPSM	600	All automotive colors and clears

BLP14CONV  
Order NO.: 903141

- Designed for the automotive refinishing painter, Blue-Point® spray guns are lightweight and feature great balance while delivering a quality, first class automotive finish
- A new generation of Blue-Point® spray guns for primer, base and clear coat
- Lowest trigger pull among guns in their class
- Unmatched spray pattern size and quality repair kits
- Optional interchangeable 125cc, 250cc and 600cc aluminum cups are available
- Optional 3M PPS adaptor is also available

## 1.4 HVLP Spray Gun

Packing: 1



Fluid Tip (mm)	Air Consumption (scfm)
1.4	14.5
Air Inlet Thread Size	Air Pressure Range (psi)
1/4" NPSM	30 to 43
Fluid (Water) Delivery	Cup Size (cc)
190 to 250 ml/min	600

BLPK14HVLP  
Order NO.: 903138

- Lightweight and comfortable for all kinds of painting jobs
- Provides superior spray performance
- Stainless steel needle and tip

## Windshield Removal Tool

Packing: 1



YA109C  
Order NO.: 903137

- Steel cable pull handle
- Replaceable steel cutting blades can be resharpened
- For GM, Chrysler, and other cars with windshields set in place with sealant

## Brake Service Tools

Packing: 1



YA4000B  
Order NO.: 903146

- Produces vacuum or pressure at the turn of a switch
  - Comfortable ergonomic design
  - One finger trigger vacuum/pressure release
  - Durable, accurate diaphragm type pressure/vacuum gauge
  - Handheld vacuum/pressure pump with 2" compound gauge and rubber boot
  - 12 oz. fluid reservoir bottle with fluid transfer and storage lids plus fluid pick up tube
  - 6 tapered adaptors for connecting to tubing from .09" to .50" ID
  - 2 tapered manifold plugs
  - 2 universal bleed screw adaptors
  - 12 vacuum cap plugs, vacuum line T-adaptor
  - (2) 1/4" ID x 24" long connection tubes with quick-change connector
  - 5/32" ID x 1/4" ID tubing adaptor
  - 5/32" ID x 3" long vacuum test tube
  - Rubber cupped adaptor
  - Master cylinder refill kit
- Applications:
- Vacuum and pressure related engine performance diagnostics and tune-ups
  - Brake bleeding
  - Fluid transfer, evacuation and sampling



# Shop & Technician Tools Automotive Specialty Tools

## Door Lockout Set

Packing: 1

LOS145A  
Order NO.: 903136



- No danger of airbag activation or disconnected door linkages
- Actuate the door handle, manual lock button or electric lock button on most cars and trucks
- Includes: 4 pc door-unlocking tool that screws together without couplers for easy assembly and storage, plastic slim jim, 2 glow-in-the-dark tips, 2 plastic wedges to create gap between door and frame without damaging door or weather stripping and BF272 inflatable wedge
- Use the BF272 to easily separate door from body without damage to the vehicle
- Unlocking tool features a middle extension piece to reach across the car in extended use applications
- For sale to registered locksmiths, police and bona fide repair professionals only

## Thread Setter Kits



Stock No.		Order No.
HP650	1	903134
HP650M	1	903135

### HP650

- Includes: rugged thread setter tool and an assortment of fractional Klik Poly-Nuts: 12 each 8-32, 10-24, 10-32; (8) 1/4"-20 and (6) 5/16"-18 threads
- Includes required nosepieces and mandrels for setting the above sizes
- Packaged in a storage case

### HP650M

- Metric version of the HP650 with metric poly-nuts, including 25 each 4 and 5mm, (15) 6mm and (10) 8mm threads
- Includes thread setter tool, required nosepieces and mandrels packaged in a storage case

## High Volume Hose Connectors



AHCC90C



AHCC91C



AHCCP90C



AHCCP97C

Stock No.	Description	Size		Order No.
AHCC90C	Quick Coupler High volume 1/4" female quick coupler	1/4"	1	903147
AHCC91C	Quick Coupler High volume 1/4" male quick coupler	1/4"	1	903148
AHCCP90C	Nipple (1/4" Female) Quick connect 1/4" female nipple	1/4"	1	903149
AHCCP97C	Impact Wrench Adaptor	1/2"	1	903150

### AHCC90C AHCC91B AHCCP90C

- Designed to deliver high volumes of air to spray guns and air tools

### AHCCP97C

- Use with AHCC98C high flow coupler to improve low pressure performance of 1/2" drive impact wrenches and other high air consumption tools





# Shop Equipment

Bringing on bigger sized gear, we have some heavier equipment further catering to automotive specialized needs. All equipment conform to Blue-Point's quality commitment, and complement the rest of our quality tools to be the number one choice in automotive tools.



---

# Blue-Point

---



**at**®  
TM

Shop Equipment

160

# Shop Equipment Shop Equipment

## Floor Jack



Stock No.	Capacity (tons)	Min. Height	Max. Height	Dimension	Net Weight		Order No.
YF2AP	2	70 mm	490 mm	750 x 364 x 180 mm	42kg	1	904013
YF3AP	3	90 mm	552 mm	790 x 364 x 180 mm	45kg	1	904014

- Low Profile
- Dual hydraulic cylinders
- Soft rollers for smoother & silent operation

## 3-1/2 Ton Floor Jack

Packing: 1



YA1707  
Order NO.: 904004

Stock No.	Capacity (tons)	Max Lift Height (inches)	Low Height (inches)	Saddle Size (inches)	Frame Length (inches)	Handle Length (inches)	Weight (lbs)
YA1707	3 1/2	22	3 3/4	4 1/4	29 7/8	50	103

- Fast acting pump reaches lifting height in less than a pump to allow user to reach a variety of service height situations quickly
- One piece handle for professional users features a foam pad to limit damage to vehicles
- Universal joint release mechanism for smooth action
- Rolled side frames with generous flanges to resist flexing
- Low profile design allows for easy access under vehicles
- Floor Jack used to lift cars and light trucks
- Meets ANSI-PALD standards

## Motorcycle Floor Jack

Packing: 1



YA1715  
Order NO.: 904009

- 1,500 pound capacity
- Low height of 4 1/2", maximum height of 14 3/4"
- Wide base for extra stability
- Double rubber lined pad provides extra protection to motorcycle while on the jack
- Pull handle assists user to maneuver jack into position
- One foot operation for ease of use
- Safety straps to secure motorcycle to jack
- Self locking safety feature and overload safety valve

## 12 Ton Jack Stands

Packing: 1

YA512  
Order NO.: 904006



Stock No.	Capacity (tons)	Low Height (inches)	Maximum Height (inches)
YA512	12 (per pair)	17 1/2	27 1/2

- Counter-weighted pawl serves as a secure locking device to prevent the load from accidentally disengaging
- Sturdy, welded steel construction for superior strength
- One piece, multi-position ductile ratchet bar provides super strength and durability and quick adjustment mechanism that securely locks into desired location

## Automotive Jack Stands

Packing: 1

YA874BP  
Order NO.: 904012



Stock No.	Capacity (tons)	Max. Height	Min. Height	COO
YA874BP	3 (each piece)	430mm	290mm	China

## 1/2 Ton Trans Jack

Packing: 1

YA714D  
Order NO.: 904007



Capacity (tons)	Maximum Height (inches)	Saddle Base (inches)	Lifting Head Size (inches)
1/2	69 7/8	8 7/8 x 7 1/8	15 1/2 x 15 1/2
Handle Length (inches)	Chassis Length (inches)	Chassis Width (inches)	Tilt
11	—	33 1/2	12°
Minimum Height (inches)	Exp.Saddle Area (inches)	Jack Size (inches)	Net Weight, lbs. (kg)
33	21 x 21	34 1/8 (L) x 36 1/8 (W)	181 (82.1)

- Crank for precise and easy alignment
- Four adjustment load support arms fit most transmission pan flanges
- Adjustable to 0.030 inches or less
- Foot pedal pump permits hands free operation
- Wide base and four casters for stability

# Shop Equipment Shop Equipment

## Engine Crane

Packing: 1



YA12AP

Order NO.: 904011

Capacity	Min. Height	Max. Height	Dimension
2 Ton	340 mm	1,797 mm	1,830 x 760 x 1,550 mm
Certificate	Net Weight	Gross Weight	Packaging
2005 ASME/ PALD	109 kg	114 kg	#1 - 810 x 570 x 90 mm #2 - 1,695 x 195 x 85 mm #3 - 1,295 x 315 x 170 mm

## Bottle Jacks

Packing: 1



Stock No.	Capacity (tons)	Min Height (inches)	Max Height (inches)	Adjust Height (inches)	Base (inches)	Handle (inches)
YB2AP	2	6 3/4	14 5/8	4 2/5	4 x 4 1/10	16 1/2
YB3AP	3	6 3/4	14 5/8	4 2/5	4 x 4 1/10	16 1/2
YB5AP	5	8 1/3	18 2/5	5 3/4	4 1/3 x 4 2/5	16 1/2

Stock No.	Cap Dia (inches)	Operating Force (lbs)	Packing	Order No.
YB2AP	1 1/10	45	1	904015
YB3AP	1 1/10	78.75	1	904016
YB5AP	1 1/4	90	1	904017

- Improved Design with Welded Joints to Prevent Seal Leakage

## 8 Ton Bottle Jack

Packing: 1



YA1228

Order NO.: 904005

Capacity (tons)	Low Height (inches)	Maximum Height (inches)	Screw Extension (inches)
8	8 1/8	17 5/8	2 3/4
Base Size (inches)	Handle Length (inches)	Cap Diameter (inches)	Operating Force (lbs.)
4 3/4 x 4 3/4	18 1/8 (assembled)	1 3/8	101

- Hydraulic system is protected from internal damage by a patented by-pass mechanism
- Machined and polished cylinders with die-cut threading provide non-abrasive leak-free, durable performance
- Fabricated from hard-cast steel

## Heavy Duty Workbench

Packing: 1



BPWORKBENCH

Order NO.: 904001

- Features a full bottom shelf and superior powder coat finish
- Dimensions-60.08" x 30.73" x 34.08"
- Net Weight-138.9 lbs. (63.06 kg)
- Weight Capacity-1,200 lbs.
- Top panel: 2.0mm thickness
- Bottom shelf: 2.0mm thickness
- Steel support: 2.5mm thickness

## Welder & Plasma Cutter Cart

Packing: 1

MIGCARTA

Order NO.: 904002



Overall Dimensions	Shipping Weight (lbs.)
41" L x 19 1/2" W x 25" H	43

- Welder and plasma cutter cart features two trays along with 20" (L) x 12.75" (W) top tray to hold MIG welders and plasma cutters
- Includes cylinder bracket with adjustable chain to hold multiple diameter gas bottles
- Handle has storage tray for smaller items



WARNING





























Do not exceed capacity of jacks or jack stands • Do not work on vehicles supported by jack, use jack stands  
Use jack and jack stands only on hard level surfaces • Read safety precautions on page 162



**Important Words  
About Safety  
for Users and Bystanders**

*Following these basic safety rules  
is a good start toward  
protecting yourself and others  
in the vicinity  
from injury while using tools*

- Wear safety goggles
- Use the right tool
- Use the tool properly
- Maintain the tool regularly
- Keep tools away from children
- Do not use tools on live electrical circuits unless specifically designed for such use
- Read and follow instructions

Prohibited Actions	Mandatory Actions	Hazard Alerts
 <p><b>THIS SYMBOL INDICATES PROHIBITED ACTION</b></p>	 <p><b>THIS SYMBOL INDICATES MANDATORY ACTION</b></p>	 <p><b>THIS SYMBOL INDICATES A HAZARD ALERT</b></p>
 <p>DO NOT OVER-TORQUE NO PIPES OR LEVER EXTENSIONS</p>	 <p>MANDATORY EAR PROTECTION</p>	<p><b>RED BACKGROUND – DANGER ORANGE BACKGROUND – WARNING YELLOW BACKGROUND – CAUTION</b></p>
 <p>NO HAMMERING</p>	 <p>MANDATORY FACE SHIELD</p>	 <p>VIBRATION HAZARD</p>
 <p>NO PRYING</p>	 <p>MANDATORY MASK</p>	 <p>RISK OF EXPLOSION</p>
 <p>DO NOT STRIKE HARD OBJECTS</p>	 <p>MANDATORY RESPIRATOR</p>	 <p>OVERHEAD/OVERLOAD HAZARD</p>
 <p>NO IMPACT/POWER DRIVE</p>	 <p>MANDATORY PROTECTIVE CLOTHING</p>	 <p>RISK OF ELECTRIC SHOCK</p>
 <p>DO NOT STEP IN OR ON DRAWERS</p>	 <p>MANDATORY PROTECTIVE GLOVES</p>	 <p>RISK OF FIRE</p>
 <p>DO NOT OPEN MULTIPLE DRAWERS</p>	 <p>MANDATORY EYE PROTECTION</p>	 <p>RISK OF ENTANGLEMENT</p>
 <p>DO NOT PULL TO MOVE</p>	 <p>MUST READ INSTRUCTIONS BEFORE USE</p>	
 <p>KEEP CHILDREN AWAY</p>		

Safety messages in this catalog use the guidelines of the American National Standard ANSI Z535. 4 for Product Safety Signs and Labels and ANSI Z535.3 Criteria for Safety Symbols. Messages associated with specific products use a triangular hazard alert symbol, signal word (CAUTION, WARNING, DANGER) and how to avoid the hazard.

**PLEASE READ AND FOLLOW** these messages to avoid injury to yourself and bystanders.

Snap-on Asia Pacific Division, or its assigns, ("Snap-on") warrants to customers who purchase products from authorized Blue-Point distribution channels that Blue-Point® brand products will be free from defects in workmanship and materials for a duration depending upon the nature of the product. Prior to a product purchase, customer can obtain the product warranty duration from a Blue-Point reseller. Customers may also contact the closest sales office as listed below.

During the applicable duration of the warranty, at its option, Snap-on will repair or replace its products which fail to give satisfactory service due to defective workmanship or materials, or provide a refund by repaying or crediting customer with an amount equal to the purchase price of such products. Repair, replacement or refund shall be at the election and expense of Snap-on, and is customer's exclusive remedy in place of all other rights and remedies. Any products or parts replaced or for which Snap-on has provided a refund are the property of Snap-on and will not be returned.

THE FOREGOING WARRANTY IS IN LIEU OF AND EXCLUDES ALL OTHER WARRANTIES NOT EXPRESSLY SET FORTH HEREIN, WHETHER EXPRESS, IMPLIED OR COLLATERAL, BY OPERATION OF LAW OR OTHERWISE, INCLUDING BUT NOT LIMITED TO ANY IMPLIED WARRANTIES OF MERCHANTABILITY OR FITNESS FOR A PARTICULAR PURPOSE. Descriptions of product contained in this catalog are for the sole purpose of identifying product and shall not be construed as an express warranty.

LIMITATION OF LIABILITY. SNAP-ON AND ITS AFFILIATED COMPANIES AND THIRD PARTY SUPPLIERS SHALL NOT BE LIABLE FOR ANY INCIDENTAL, SPECIAL OR CONSEQUENTIAL LOSSES, COSTS OR DAMAGES INCURRED BY CUSTOMER OR OTHERS, INCLUDING PERSONAL INJURY OR DEATH, DIRECTLY OR INDIRECTLY ARISING FROM THE SALE, HANDLING OR USE OF THE PRODUCTS, OR FROM ANY OTHER CAUSE WITH RESPECT TO THE PRODUCTS OR THE FOREGOING WARRANTY, WHETHER SUCH CLAIM IS BASED UPON BREACH OF CONTRACT, BREACH OF WARRANTY, STRICT LIABILITY IN TORT, NEGLIGENCE OR ANY OTHER LEGAL THEORY (INCLUDING WITHOUT LIMITATION, LOST PROFITS, REVENUES, ANTICIPATED SALES, BUSINESS OPPORTUNITIES, GOODWILL, OR INTERRUPTION OF BUSINESS OR OTHER INJURY OR DAMAGE).

Snap-on® and Blue-Point® are registered trademarks of Snap-on Incorporated

## SNAP-ON ASIA PACIFIC OFFICES

### Asia / Pacific Division

25 Tagore Lane, #01-02  
Singapore 787602  
Tel: +(65) 6459-2712  
Fax: +(65) 6459-1520

### Snap-on Trading (Shanghai) Co., Ltd.

Unit 2001-2005, Cross Tower  
318 Fuzhou Road, Shanghai 200001  
P.R.China  
Tel: +(86-21) 6391-2388  
Fax: +(86-21) 6391-2382

### Snap-on Trading (Shanghai) Co., Ltd. Beijing Branch

517B, Grand Pacific Building  
8A Guanghua Road  
Beijing 100026  
P.R.China  
Tel: +(86-10) 6581-8838  
Fax: +(86-10) 6581-6681

### Snap-on Tools India Private Ltd.

6/2, Begumpur Khatola,  
39 Milestone, NH-8, Gurgaon,  
Haryana-122004, India  
Tel: +(91-124) 459-9700  
Fax: +(91-124) 405-6866

### Snap-on Tools Japan, K.K.

2-1-6 Shinkiba, Koto-ku,  
Tokyo, 136-0082 Japan  
Tel: +(81-3) 5534-1285  
Fax: +(81-3) 5534-1284

### Snap-on Tools Hong Kong Ltd.

Unit 2010, 20/F, Laford Centre,  
838 Lai Chi Kok Road,  
Cheung Sha Wan, Kowloon  
Hong Kong  
Tel: +(852) 2370-3700  
Fax: +(852) 2370-3400

### Snap-on Tools Korea Ltd.

#505, Building 301,  
Bucheon Techno Park Block 3  
365 SamJung-Dong,  
OhJung-Gu, Bucheon City  
GyeongGi-Do 421-809, Korea  
Tel: +(82-32) 326-7310  
Fax: +(82-32) 326-7312

### Snap-on Tools Singapore Pte. Ltd.

25 Tagore Lane, #01-01  
Singapore 787602  
Tel: +(65) 6451-5570  
Fax: +(65) 6451-5574

### Snap-on Tools Singapore Pte. Ltd. Indonesia Representative Office

Graha Pratama Building, 20th Floor  
Jl. M. T. Haryono Kav.15,  
Jakarta 12810, Indonesia  
Tel: +(62-21) 8370-9611  
Fax: +(62-21) 8370-9612

### Snap-on Tools Singapore Pte. Ltd. Malaysia Branch

B-6-10, Street Mall, One South  
Jalan OS, Taman Serdang Perdana  
43300 Seri Kembangan, Selangor  
Malaysia  
Tel: +(603) 8957-1938  
Fax: +(603) 8957-2938

### Snap-on Tools Singapore Pte. Ltd. Philippines Branch

4/F, 2053 Building, Edison Street  
San Isidro, Makati City  
Philippines 1234  
Tel: +(63-2) 843-7935  
Fax: +(63-2) 843-7730

### Snap-on Tools Singapore Pte. Ltd. Taiwan Branch

3F-4, #9 Wuquan 1st Road, New Taipei  
Industrial Park, Xinzhuang District  
24892, New Taipei City, Taiwan ROC  
Tel: +(886-2) 2298-9789  
Fax: +(886-2) 2298-2288

### Snap-on (Thailand) Company Ltd.

5th Floor, Talomsin Building,  
924 Rama 3 Road  
Bangpongpang Yannawa,  
Bangkok 10120, Thailand  
Tel: +(66) 2294-9660  
Fax: +(66) 2294-9665



WARNING



• Do not exceed capacity of jacks or jack stands • Do not work on vehicles supported by jack, use jack stands  
• Use jack and jack stands only on hard level surfaces • Read safety precautions on page 162

## Sub-Category

<b>1/2" Sockets, Ratchets &amp; Accessories</b> .....	33-37
<b>1/4" Sockets, Ratchets &amp; Accessories</b> .....	22-26
<b>3/4" Sockets, Ratchets &amp; Accessories</b> .....	37
<b>3/8" Sockets, Ratchets &amp; Accessories</b> .....	27-32
<b>Adjustable Click-Type Torque Wrenches</b> .....	72
<b>Adjustable Wrenches</b> .....	42-43
<b>Air Tools</b> .....	78-92
<b>Automotive Specialty Tools</b> .....	136-157
<b>Automotive Tool Sets</b> .....	14-16
<b>Bits</b> .....	53
<b>Combination Wrenches</b> .....	43
<b>Cordless Tools</b> .....	93-94
<b>Cutting Tools</b> .....	111-115
<b>Digital Torque Testers</b> .....	75
<b>Double Open End Wrenches</b> .....	43
<b>Electronic Type Torque Wrenches</b> .....	74
<b>Flashlights</b> .....	122-124
<b>General Service Sets</b> .....	10-14
<b>Hammers</b> .....	108-110
<b>Impact Sockets</b> .....	94-101
<b>L and T shape Wrenches</b> .....	47
<b>Locking Pliers</b> .....	68-69
<b>Measuring Tools</b> .....	118-121
<b>Miscellaneous</b> .....	126-129
<b>Modular Tool Sets</b> .....	17-19
<b>Offset Box Wrenches</b> .....	44
<b>Other Wrenches</b> .....	47
<b>Plier Sets</b> .....	56-58
<b>Power Tools Accessories</b> .....	102-105
<b>Preset Click-Type Torque Wrenches</b> .....	72-73
<b>Punches &amp; Chisels</b> .....	110
<b>Ratcheting Wrenches</b> .....	44-47
<b>Retaining Ring Pliers</b> .....	69
<b>Roll Cab Accessories</b> .....	7
<b>Roll Cabinets</b> .....	2-3
<b>Roll Carts</b> .....	3-4
<b>Safety Tools</b> .....	124-125
<b>Screwdrivers</b> .....	50-52
<b>Shop Equipment</b> .....	160-161
<b>Special Pliers</b> .....	69
<b>Special Tools</b> .....	134-136
<b>Standard Pliers</b> .....	58-66
<b>Testing and Electronics</b> .....	132-133
<b>Tool Boxes</b> .....	4-6
<b>VDE Pliers</b> .....	67
<b>Wrench Sets</b> .....	40-42

## INDEX

### 1-9

1412A .....	134
1470K-AC1 .....	7
1470K-AC2 .....	7
1470K-AC4 .....	7
1470K-ACSIDE .....	7
1658C .....	134
2420A .....	134
2430C .....	134
2438C .....	134
2842C .....	134

### A

A91E .....	150
A1310A .....	154
AC2Z40T27MP .....	102
AC2Z60T27MP .....	102
AC2Z80T27MP .....	102
AC4Z60T27MP .....	102
AC17D .....	103
AC243 .....	103
AC420A .....	103
AC421A .....	103
AC616 .....	103
AC3160FWMP .....	103
AC3180FWMP .....	103
AC10302 .....	103
AC10306 .....	103
AC31120FWMP .....	103
ACT73A .....	144
ACT83A .....	144
ACT106B .....	145
ACT111B .....	146
ACT118B .....	145
ACT119 .....	146
ACT407 .....	144
ACT499A .....	145
ACT1008A .....	145
ACT1009A .....	145
ACT1046C .....	145
ACT1234PKT .....	143
ACT1290A .....	146
ACT1370 .....	146
ACT81290 .....	145
ACTB72 .....	143
ACTB72A .....	143
ACTMAN2100 .....	144
ACTR4131A .....	143
ACTRB72 .....	144
ACTRB96 .....	144
ACTRR72 .....	144
ACTRR96 .....	144
ACTRY72 .....	144
ACTRY96 .....	144
ACTY72 .....	143
ACTY72A .....	143
AF102 .....	147
AHC21D .....	105
AHC21FD .....	105
AHC21MD .....	105
AHC21PD .....	104
AHC21PMD .....	105
AHC22E .....	105
AHC22FD .....	105
AHC22MD .....	105
AHC23D .....	105
AHC23FD .....	105



AHC23MD .....	105
AHC23PMD .....	105
AHC24D .....	105
AHC24FD .....	105
AHC24MD .....	105
AHC25D .....	105
AHC25FD .....	105
AHC25MD .....	105
AHC26D .....	105
AHC26FD .....	105
AHC26MD .....	105
AHC27D .....	105
AHC27FD .....	105
AHC28D .....	105
AHC28FD .....	105
AHC28MD .....	105
AHCC90C .....	157
AHCC91C .....	157
AHCCP90C .....	157
AHCCP97C .....	157
AHRB200 .....	102
AIRHOSE35 .....	104
AT105 .....	85
AT109 .....	85
AT109DGK .....	85
AT115 .....	84
AT118 .....	85
AT119 .....	86
AT119DGK .....	86
AT123B .....	79
AT153 .....	87
AT154 .....	87
AT157R .....	87
AT180C .....	89
AT184 .....	83
AT185 .....	88
AT192A .....	88
AT194A .....	88
AT195 .....	88
AT200D .....	82
AT203A .....	82
AT204 .....	83
AT215 .....	88
AT235MCA .....	81
AT321 .....	80
AT351 .....	80
AT370 .....	80
AT380A .....	80
AT401MCA .....	91
AT401MCKA .....	92
AT402MCA .....	91
AT402MCKA .....	92
AT403MCA .....	91
AT403MCKA .....	92
AT408 .....	89
AT411A .....	89
AT415B .....	86
AT415CWMP .....	102
AT415T27MP .....	102
AT425R .....	90
AT435A .....	91
AT460BP .....	92
AT475A .....	90
AT555B .....	78
AT570 .....	79
AT670 .....	78
AT700F .....	82
AT702 .....	81
AT704A .....	81
AT705B .....	81
AT738 .....	82
AT801MCA .....	84
AT811 .....	84

AT1070A .....	86
AT1070RA .....	86
AT1300A .....	78
AT2050 .....	84
AT3000 .....	83
AT5000 .....	83
ATC500 .....	78
AV1000A .....	128

**B**

B45CMPAP .....	56
B48CPAP .....	56
B58HLPAP .....	56
B65CMPAP .....	56
B75CMPAP .....	56
B85CMPAP .....	56
B85CTMPAP .....	56
B87CPAP .....	62
B95CLMPAP .....	56
B95CMPAP .....	56
B96CPAP .....	56
B240B .....	155
B945CMPAP .....	56
B960CMPAP .....	56
BADJC6 .....	43
BADJC6AP .....	43
BADJC8 .....	43
BADJC8AP .....	43
BADJC10 .....	43
BADJC10AP .....	43
BADJC703 .....	40
BAWP100AP .....	56
BB500 .....	153
BBWDM67 .....	44
BBWDM89 .....	44
BBWDM810 .....	44
BBWDM1011 .....	44
BBWDM1012 .....	44
BBWDM1113 .....	44
BBWDM1213 .....	44
BBWDM1214 .....	44
BBWDM1415 .....	44
BBWDM1417 .....	44
BBWDM1617 .....	44
BBWDM1719 .....	44
BBWDM1819 .....	44
BBWDM1921 .....	44
BBWDM1922 .....	44
BBWDM2022 .....	44
BBWDM2123 .....	44
BBWDM2224 .....	44
BBWDM2326 .....	44
BBWDM2426 .....	44
BBWDM2427 .....	44
BBWDM2430 .....	44
BBWDM2528 .....	44
BBWDM2730 .....	44
BBWDM3032 .....	44
BBWDM3436A .....	44
BBWSM67 .....	44
BBWSM89 .....	44
BBWSM810 .....	44
BBWSM911 .....	44
BBWSM1011 .....	44
BBWSM1012 .....	44
BBWSM1113 .....	44
BBWSM1213 .....	44
BBWSM1214 .....	44
BBWSM1314 .....	44
BBWSM1415 .....	44
BBWSM1417 .....	44
BBWSM1516 .....	44

BBWSM1617 .....	44
BBWSM1719 .....	44
BBWSM1819 .....	44
BBWSM1921 .....	44
BBWSM1922 .....	44
BBWSM2022 .....	44
BBWSM2122 .....	44
BBWSM2123 .....	44
BBWSM2224 .....	44
BBWSM2326 .....	44
BBWSM2426 .....	44
BBWSM2427 .....	44
BBWSM2528 .....	44
BBWSM2730 .....	44
BBWSM2732 .....	44
BBWSM3032 .....	44
BBWSM3436 .....	44
BC45G .....	110
BCB6HD .....	61
BCB7HD .....	61
BCB9HD .....	61
BCC6HD .....	61
BCC8HD .....	61
BCC10HD .....	61
BCEH5 .....	65
BCEH6 .....	65
BCER5 .....	66
BCER6 .....	66
BCER7 .....	60
BCER9 .....	60
BCE55 .....	65
BCE56 .....	65
BCE57 .....	60
BCE59 .....	60
BCIH5 .....	65
BCIH6 .....	65
BCIR5 .....	65
BCIR6 .....	65
BCIR7 .....	60
BCIR9 .....	60
BCIS5 .....	65
BCIS6 .....	65
BCIS7 .....	60
BCIS9 .....	60
BCT6HD .....	61
BCT7HD .....	61
BCT8HD .....	61
BD45G .....	110
BDG45CMP .....	56
BDG48CPZ .....	56
BDG57CPZ .....	56
BDG65CMP .....	56
BDG85CMP .....	56
BDG85CTMP .....	57
BDG86CPZ .....	56
BDG86LMPZ .....	57
BDG88CPZ .....	56
BDG945CMP .....	56
BDG95CLMP .....	56
BDG95CMP .....	56
BDG96LMPZ .....	57
BDG97LMPZ .....	57
BDG98CPZ .....	56
BDG311CPZ .....	57
BDG911CPZ .....	57
BDG916CPZ .....	57
BDG9645LMPZ .....	57
BDG9845CPZ .....	56
BDG91145CPZ .....	57
BDG91645CPZ .....	57
BDGAWP100Z .....	56
BDGCB8K .....	59
BDGCB9HK .....	59

BDGCT6K	58
BDGCT6W	61
BDGEC7Z	56
BDGLN6K	60
BDGLP7SAP	68
BDGLP10SAP	68
BDGMPEC5	56
BDGPL200XLR	57
BDGPL300HG	57
BDGPL300LR	57
BDGPL400LMP	57
BDGPL410HGZ	57
BDGPL411HGZ	57
BDGPL412HGZ	57
BDGPL800	52
BDMAJ10	63
BDMCB6	62
BDMCB7	62
BDMCB8	62
BDMCT5	62
BDMCT6	62
BDMCT7	62
BDMLN6	63
BDMLN8	63
BDMLP7S	68
BDMLP10S	68
BDOE1012	43
BDOE1416	43
BDOE1820	43
BDOE2224	43
BDOEM67	43
BDOEM68	43
BDOEM89	43
BDOEM810	43
BDOEM1011	43
BDOEM1012	43
BDOEM1113	43
BDOEM1213	43
BDOEM1214	43
BDOEM1314	43
BDOEM1415	43
BDOEM1417	43
BDOEM1617	43
BDOEM1719	43
BDOEM1819	43
BDOEM1921	43
BDOEM1922	43
BDOEM2022	43
BDOEM2123	43
BDOEM2224	43
BDOEM2326	43
BDOEM2426	43
BDOEM2427	43
BDOEM2528	43
BDOEM3032	43
BF555	154
BF620C	109
BF623	109
BH141A	108
BH142A	108
BH232A	109
BKB6500	132
BL1B	143
BLED1	122
BLP10MHVLP	156
BLP13HVLP	156
BLP14CONV	156
BLP14HVLP	156
BLP15HVLP	156
BLP18HVLP	156
BLP404	61
BLPADJ404	40
BLPADJ404SG	40

BLPADJ703	40
BLPAFM1238	35
BLPAFM1438	25
BLPAFM3812	30
BLPAFM3814	30
BLPAIM134	99
BLPAIM341	101
BLPAIM1121	101
BLPAIM1234	99
BLPAIM1238	95
BLPAIM3412	97
BLPAIM3812	95
BLPAIM3814	95
BLPATSCM100	14
BLPATSCM120	15
BLPATSCM128	15
BLPATSIMM1215	16
BLPATSIMM3813	16
BLPATSM1225	16
BLPATSM1232	16
BLPATSM1429	14
BLPATSM3824	15
BLPATSM3877	14
BLPBB146	24
BLPBB1210	36
BLPBB1215	36
BLPBB1224	36
BLPBB3419	37
BLPBB3810	30
BLPBC18	69
BLPBC18-1	69
BLPBC24	69
BLPBC24-1	69
BLPBC30	69
BLPBC30-1	69
BLPBC36	69
BLPBC36-1	69
BLPSS40	11
BLPCGHD146	24
BLPCGHD388	32
BLPCWM6AP	43
BLPCWM7AP	43
BLPCWM8AP	43
BLPCWM9AP	43
BLPCWM10AP	43
BLPCWM11AP	43
BLPCWM12AP	43
BLPCWM13AP	43
BLPCWM14AP	43
BLPCWM15AP	43
BLPCWM16AP	43
BLPCWM17AP	43
BLPCWM18AP	43
BLPCWM19AP	43
BLPCWM20AP	43
BLPCWM21AP	43
BLPCWM22AP	43
BLPCWM23AP	43
BLPCWM24AP	43
BLPCWM25AP	43
BLPCWM26AP	43
BLPCWM27AP	43
BLPCWM28AP	43
BLPCWM29AP	43
BLPCWM30AP	43
BLPCWM31AP	43
BLPCWM32AP	43
BLPCWM33AP	43
BLPCWM34AP	43
BLPCWM36	43
BLPCWM38	43
BLPCWM41	43
BLPCWM46	43

BLPD121	34
BLPD1212	34
BLPD1234	34
BLPD1238	34
BLPD1258	34
BLPD1278	34
BLPD12516	34
BLPD12716	34
BLPD12916	34
BLPD121116	34
BLPD121316	34
BLPD121516	34
BLPDB12114	34
BLPDB12118	34
BLPDB121116	34
BLPDM128	34
BLPDM129	34
BLPDM1210	34
BLPDM1211	34
BLPDM1212	34
BLPDM1213	34
BLPDM1214	34
BLPDM1215	34
BLPDM1216	34
BLPDM1217	34
BLPDM1218	34
BLPDM1219	34
BLPDM1220	34
BLPDM1221	34
BLPDM1222	34
BLPDM1223	34
BLPDM1224	34
BLPDM1227	34
BLPDM1230	34
BLPDM1232	34
BLPDM3419	37
BLPDM3421	37
BLPDM3422	37
BLPDM3423	37
BLPDM3424	37
BLPDM3425	37
BLPDM3426	37
BLPDM3427	37
BLPDM3428	37
BLPDM3429	37
BLPDM3430	37
BLPDM3432	37
BLPDM3433	37
BLPDM3434	37
BLPDM3435	37
BLPDM3436	37
BLPDM3438	37
BLPDM3440	37
BLPDM3446	37
BLPDM3450	37
BLPDM3455	37
BLPDM3460	37
BLPEXIM17	101
BLPEXIM113	101
BLPEXIM123	97
BLPEXIM125	97
BLPEXIM126	97
BLPEXIM343	99
BLPEXIM344	99
BLPEXIM346	99
BLPEXIM347	99
BLPEXIM348	99
BLPEXIM383	95
BLPEXIM386	95
BLPEXIM1210	97
BLPEXIM3410	99
BLPEXIM3413	99
BLPEXT344	37

BLPEXT348 .....	37	BLPHBM5 .....	53	BLPLM1232 .....	33
BLPEXT3416 .....	37	BLPHBM6 .....	53	BLPLM3810 .....	27
BLPEXTF146 .....	24	BLPHL124 .....	37	BLPLM3811 .....	27
BLPEXTK123 .....	35	BLPHL125 .....	37	BLPLM3812 .....	27
BLPEXTK125 .....	35	BLPHL126 .....	37	BLPLM3813 .....	27
BLPEXTK126 .....	35	BLPHL127 .....	37	BLPLM3814 .....	27
BLPEXTK383 .....	29	BLPHL128 .....	37	BLPLM3815 .....	27
BLPEXTK386 .....	29	BLPHL1210 .....	37	BLPLM3816 .....	27
BLPEXTK1210 .....	35	BLPHL1212 .....	37	BLPLM3817 .....	27
BLPEXTK3810 .....	29	BLPHL1214 .....	37	BLPLM3818 .....	27
BLPEXTL1412 .....	24	BLPHL1217 .....	37	BLPLM3819 .....	27
BLPEXTL1418 .....	24	BLPHSM0142 .....	25	BLPLM3820 .....	27
BLPEXTL1424 .....	24	BLPHSM0143 .....	25	BLPLM3821 .....	27
BLPEXTL3812 .....	29	BLPHSM0144 .....	25	BLPLM3822 .....	27
BLPEXTL3818 .....	29	BLPHSM0145 .....	25	BLPLM3823 .....	27
BLPEXTL3824 .....	29	BLPHSM0146 .....	25	BLPLM3824 .....	27
BLPFB14 .....	53	BLPHSM0147 .....	25	BLPLS1412 .....	22
BLPFB316 .....	53	BLPHSM0148 .....	25	BLPLS1414 .....	22
BLPFB532 .....	53	BLPHSM0149 .....	25	BLPLS1438 .....	22
BLPFB732 .....	53	BLPHSM01410 .....	25	BLPLS1458 .....	22
BLPFB932 .....	53	BLPHSM01425 .....	25	BLPLS14316 .....	22
BLPFS01414 .....	26	BLPJIM1 .....	101	BLPLS14516 .....	22
BLPFS01438 .....	26	BLPJIM12 .....	97	BLPLS14716 .....	22
BLPFT144 .....	26	BLPJIM34 .....	99	BLPLS14732 .....	22
BLPFT145.5 .....	26	BLPJIM38 .....	95	BLPLS14916 .....	22
BLPFT146.5 .....	26	BLPK14HVLP .....	156	BLPLS14932 .....	22
BLPFT388 .....	32	BLPL121 .....	29	BLPLS141132 .....	22
BLPFT3855 .....	32	BLPL381 .....	28	BLPLSIM121 .....	96
BLPFT3865 .....	32	BLPL1212 .....	33	BLPLSIM1212 .....	96
BLPGSS1233 .....	13	BLPL1234 .....	33	BLPLSIM1234 .....	96
BLPGSS1422 .....	12	BLPL1238 .....	33	BLPLSIM1238 .....	96
BLPGSS1427 .....	14	BLPL1258 .....	33	BLPLSIM1258 .....	96
BLPGSS1451A .....	12	BLPL1278 .....	33	BLPLSIM1278 .....	96
BLPGSS1462 .....	11	BLPL3812 .....	28	BLPLSIM3812 .....	95
BLPGSS3837 .....	13	BLPL3814 .....	28	BLPLSIM3814 .....	95
BLPGSS3849 .....	13	BLPL3834 .....	28	BLPLSIM3834 .....	95
BLPGSS3885 .....	12	BLPL3838 .....	28	BLPLSIM3838 .....	95
BLPGSSC100 .....	11	BLPL3858 .....	28	BLPLSIM3858 .....	95
BLPGSSC155 .....	10	BLPL3878 .....	28	BLPLSIM12716 .....	96
BLPGSSCM78 .....	10	BLPL12716 .....	33	BLPLSIM12916 .....	96
BLPGSSCT71 .....	12	BLPL12916 .....	33	BLPLSIM38516 .....	95
BLPH123 .....	36	BLPL38516 .....	28	BLPLSIM38716 .....	95
BLPH124 .....	36	BLPL38716 .....	28	BLPLSIM38916 .....	95
BLPH125 .....	36	BLPL38916 .....	28	BLPLSIM121116 .....	96
BLPH125L180 .....	36	BLPL121116 .....	33	BLPLSIM121316 .....	96
BLPH126 .....	36	BLPL121316 .....	33	BLPLSIM121516 .....	96
BLPH126L70 .....	36	BLPL121516 .....	33	BLPLSIM381116 .....	95
BLPH126L140 .....	36	BLPL381116 .....	28	BLPLSIMB12114 .....	96
BLPH126L250 .....	36	BLPL381316 .....	28	BLPLSIMB12116 .....	96
BLPH127 .....	36	BLPL381516 .....	28	BLPLSIMB12118 .....	96
BLPH128 .....	36	BLPLB12118 .....	33	BLPLSIMB121316 .....	96
BLPH128L120 .....	36	BLPLB121116 .....	33	BLPLSM144 .....	22
BLPH383 .....	32	BLPLB125114 .....	33	BLPLSM145 .....	22
BLPH384 .....	32	BLPLM386 .....	27	BLPLSM146 .....	22
BLPH385 .....	32	BLPLM387 .....	27	BLPLSM147 .....	22
BLPH386 .....	32	BLPLM388 .....	27	BLPLSM148 .....	22
BLPH387 .....	32	BLPLM389 .....	27	BLPLSM149 .....	22
BLPH388 .....	32	BLPLM1210 .....	33	BLPLSM1410 .....	22
BLPH1210 .....	36	BLPLM1211 .....	33	BLPLSM1411 .....	22
BLPH1210L140 .....	36	BLPLM1212 .....	33	BLPLSM1412 .....	22
BLPH1212 .....	36	BLPLM1213 .....	33	BLPLSM1413 .....	22
BLPH1214 .....	36	BLPLM1214 .....	33	BLPLSM1414 .....	22
BLPH1217 .....	36	BLPLM1215 .....	33	BLPLSMIM117 .....	100
BLPH1219 .....	36	BLPLM1216 .....	33	BLPLSMIM118 .....	100
BLPH3810 .....	32	BLPLM1217 .....	33	BLPLSMIM119 .....	100
BLPHB14 .....	53	BLPLM1218 .....	33	BLPLSMIM120 .....	100
BLPHB18 .....	53	BLPLM1219 .....	33	BLPLSMIM121 .....	100
BLPHB316 .....	53	BLPLM1220 .....	33	BLPLSMIM122 .....	100
BLPHB532 .....	53	BLPLM1221 .....	33	BLPLSMIM123 .....	100
BLPHB732 .....	53	BLPLM1222 .....	33	BLPLSMIM124 .....	100
BLPHB964 .....	53	BLPLM1224 .....	33	BLPLSMIM125 .....	100
BLPHBM3 .....	53	BLPLM1227 .....	33	BLPLSMIM126 .....	100
BLPHBM4 .....	53	BLPLM1230 .....	33	BLPLSMIM127 .....	100



**WARNING**



• Do not exceed capacity of jacks or jack stands • Do not work on vehicles supported by jack, use jack stands  
 • Use jack and jack stands only on hard level surfaces • Read safety precautions on page 162

BLPLSMIM128	100
BLPLSMIM129	100
BLPLSMIM130	100
BLPLSMIM131	100
BLPLSMIM132	100
BLPLSMIM133	100
BLPLSMIM134	100
BLPLSMIM135	100
BLPLSMIM136	100
BLPLSMIM137	100
BLPLSMIM138	100
BLPLSMIM140	100
BLPLSMIM141	100
BLPLSMIM142	100
BLPLSMIM143	100
BLPLSMIM146	100
BLPLSMIM149	100
BLPLSMIM150	100
BLPLSMIM155	100
BLPLSMIM387	94
BLPLSMIM388	94
BLPLSMIM389	94
BLPLSMIM1210	96
BLPLSMIM1211	96
BLPLSMIM1212	96
BLPLSMIM1213	96
BLPLSMIM1214	96
BLPLSMIM1215	96
BLPLSMIM1216	96
BLPLSMIM1217	96
BLPLSMIM1218	96
BLPLSMIM1219	96
BLPLSMIM1221	96
BLPLSMIM1222	96
BLPLSMIM1224	96
BLPLSMIM1226	96
BLPLSMIM1227	96
BLPLSMIM1229	96
BLPLSMIM1230	96
BLPLSMIM1232	96
BLPLSMIM3417	98
BLPLSMIM3418	98
BLPLSMIM3419	98
BLPLSMIM3420	98
BLPLSMIM3421	98
BLPLSMIM3422	98
BLPLSMIM3423	98
BLPLSMIM3424	98
BLPLSMIM3425	98
BLPLSMIM3426	98
BLPLSMIM3427	98
BLPLSMIM3428	98
BLPLSMIM3429	98
BLPLSMIM3430	98
BLPLSMIM3431	98
BLPLSMIM3432	98
BLPLSMIM3433	98
BLPLSMIM3434	98
BLPLSMIM3435	98
BLPLSMIM3436	98
BLPLSMIM3437	98
BLPLSMIM3438	98
BLPLSMIM3440	98
BLPLSMIM3441	98
BLPLSMIM3442	98
BLPLSMIM3443	98
BLPLSMIM3444	98
BLPLSMIM3445	98
BLPLSMIM3446	98
BLPLSMIM3447	98
BLPLSMIM3448	98
BLPLSMIM3449	98
BLPLSMIM3450	98

BLPLSMIM3455	98
BLPLSMIM3810	94
BLPLSMIM3811	94
BLPLSMIM3812	94
BLPLSMIM3813	94
BLPLSMIM3814	94
BLPLSMIM3815	94
BLPLSMIM3816	94
BLPLSMIM3817	94
BLPLSMIM3818	94
BLPLSMIM3819	94
BLPLW3415	37
BLPMV4	128
BLPMV5	128
BLPMV6	128
BLPP140	26
BLPP141	26
BLPP142	26
BLPP143	26
BLPP144	26
BLPP381	31
BLPP382	31
BLPP383	31
BLPP384	31
BLPPB0	53
BLPPB1	53
BLPPB2	53
BLPPB3	53
BLPPB704	136
BLPPD141	26
BLPPD142	26
BLPPD143	26
BLPPD381	32
BLPPD382	32
BLPPD383	32
BLPPD384	32
BLPPS141	26
BLPPS142	26
BLPPTA3438	32
BLPPTXT3	32
BLPPTS12	31
BLPPTS34	31
BLPPTS58	31
BLPPTS58	31
BLPPTS716	31
BLPPTS916	31
BLPPTS1116	31
BLPPTSM8	31
BLPPTSM9	31
BLPPTSM10	31
BLPPTSM11	31
BLPPTSM12	31
BLPPTSM13	31
BLPPTSM14	31
BLPPTSM15	31
BLPPTSM16	31
BLPPTSM17	31
BLPPTSM18	31
BLPPTSM19	31
BLPPTS3822	13
BLPS12	36
BLPS121	33
BLPS381	28
BLPS1212	33
BLPS1234	33
BLPS1238	33
BLPS1258	33
BLPS1278	33
BLPS1412	22
BLPS1414	22
BLPS1438	22
BLPS1458	22
BLPS3812	28

BLPS3814	28
BLPS3834	28
BLPS3838	28
BLPS3858	28
BLPS3878	28
BLPS12516	33
BLPS12716	33
BLPS12916	33
BLPS14316	22
BLPS14516	22
BLPS14532	22
BLPS14716	22
BLPS14732	22
BLPS14916	22
BLPS14932	22
BLPS38516	28
BLPS38716	28
BLPS38916	28
BLPS81414	23
BLPS81438	23
BLPS121116	33
BLPS121316	33
BLPS121516	33
BLPS141132	22
BLPS381116	28
BLPS381316	28
BLPS381516	28
BLPS814516	23
BLPSB12114	33
BLPSB12118	33
BLPSB121116	33
BLPSB121316	33
BLPSH1238	36
BLPSIM121	96
BLPSIM341	99
BLPSIM1212	96
BLPSIM1234	96
BLPSIM1238	96
BLPSIM1258	96
BLPSIM1278	96
BLPSIM3434	99
BLPSIM3478	99
BLPSIM3812	95
BLPSIM3814	95
BLPSIM3834	95
BLPSIM3838	95
BLPSIM3858	95
BLPSIM12716	96
BLPSIM12916	96
BLPSIM38516	95
BLPSIM38716	95
BLPSIM38916	95
BLPSIM121116	96
BLPSIM121316	96
BLPSIM121516	96
BLPSIM341116	99
BLPSIM341316	99
BLPSIM341516	99
BLPSIM381116	95
BLPSIMB342	99
BLPSIMB12114	96
BLPSIMB12118	96
BLPSIMB34112	99
BLPSIMB34114	99
BLPSIMB34118	99
BLPSIMB34134	99
BLPSIMB34138	99
BLPSIMB34158	99
BLPSIMB34178	99
BLPSIMB121116	96
BLPSIMB121516	96
BLPSIMB121716	96
BLPSIMB341116	99

BLPSIMB341316 .....	99	BLPSMIM128 .....	100	BLPSMIM3430 .....	98
BLPSIMB341516 .....	99	BLPSMIM129 .....	100	BLPSMIM3431 .....	98
BLPSIMB341716 .....	99	BLPSMIM130 .....	100	BLPSMIM3432 .....	98
BLPSIMB341916 .....	99	BLPSMIM131 .....	100	BLPSMIM3433 .....	98
BLPSIMB3411116 .....	99	BLPSMIM132 .....	100	BLPSMIM3434 .....	98
BLPSIMB3411316 .....	99	BLPSMIM133 .....	100	BLPSMIM3435 .....	98
BLPSIMB3411516 .....	99	BLPSMIM134 .....	100	BLPSMIM3436 .....	98
BLPSM128 .....	33	BLPSMIM135 .....	100	BLPSMIM3437 .....	98
BLPSM129 .....	33	BLPSMIM136 .....	100	BLPSMIM3438 .....	98
BLPSM143.5 .....	22	BLPSMIM137 .....	100	BLPSMIM3439 .....	98
BLPSM144 .....	22	BLPSMIM138 .....	100	BLPSMIM3440 .....	98
BLPSM144.5 .....	22	BLPSMIM139 .....	100	BLPSMIM3441 .....	98
BLPSM145 .....	22	BLPSMIM140 .....	100	BLPSMIM3442 .....	98
BLPSM145.5 .....	22	BLPSMIM141 .....	100	BLPSMIM3443 .....	98
BLPSM146 .....	22	BLPSMIM142 .....	100	BLPSMIM3444 .....	98
BLPSM147 .....	22	BLPSMIM143 .....	100	BLPSMIM3445 .....	98
BLPSM148 .....	22	BLPSMIM144 .....	100	BLPSMIM3446 .....	98
BLPSM149 .....	22	BLPSMIM145 .....	100	BLPSMIM3447 .....	98
BLPSM386 .....	27	BLPSMIM146 .....	100	BLPSMIM3448 .....	98
BLPSM387 .....	27	BLPSMIM147 .....	100	BLPSMIM3449 .....	98
BLPSM388 .....	27	BLPSMIM148 .....	100	BLPSMIM3450 .....	98
BLPSM389 .....	27	BLPSMIM149 .....	100	BLPSMIM3452 .....	98
BLPSM1210 .....	33	BLPSMIM150 .....	100	BLPSMIM3454 .....	98
BLPSM1211 .....	33	BLPSMIM151 .....	100	BLPSMIM3455 .....	98
BLPSM1212 .....	33	BLPSMIM152 .....	100	BLPSMIM3456 .....	98
BLPSM1213 .....	33	BLPSMIM153 .....	100	BLPSMIM3457 .....	98
BLPSM1214 .....	33	BLPSMIM154 .....	100	BLPSMIM3458 .....	98
BLPSM1215 .....	33	BLPSMIM155 .....	100	BLPSMIM3459 .....	98
BLPSM1216 .....	33	BLPSMIM156 .....	100	BLPSMIM3460 .....	98
BLPSM1217 .....	33	BLPSMIM157 .....	100	BLPSMIM3463 .....	98
BLPSM1218 .....	33	BLPSMIM158 .....	100	BLPSMIM3465 .....	98
BLPSM1219 .....	33	BLPSMIM159 .....	100	BLPSMIM3810 .....	94
BLPSM1220 .....	33	BLPSMIM160 .....	100	BLPSMIM3811 .....	94
BLPSM1221 .....	33	BLPSMIM163 .....	100	BLPSMIM3812 .....	94
BLPSM1222 .....	33	BLPSMIM165 .....	100	BLPSMIM3813 .....	94
BLPSM1223 .....	33	BLPSMIM166 .....	100	BLPSMIM3814 .....	94
BLPSM1224 .....	33	BLPSMIM167 .....	100	BLPSMIM3815 .....	94
BLPSM1227 .....	33	BLPSMIM168 .....	100	BLPSMIM3816 .....	94
BLPSM1230 .....	33	BLPSMIM169 .....	100	BLPSMIM3817 .....	94
BLPSM1232 .....	33	BLPSMIM387 .....	94	BLPSMIM3818 .....	94
BLPSM1234 .....	33	BLPSMIM388 .....	94	BLPSMIM3819 .....	94
BLPSM1236 .....	33	BLPSMIM389 .....	94	BLPSMS8 .....	95
BLPSM1410 .....	22	BLPSMIM1210 .....	96	BLPSMS10 .....	95
BLPSM1411 .....	22	BLPSMIM1211 .....	96	BLPSMS12 .....	95
BLPSM1412 .....	22	BLPSMIM1212 .....	96	BLPSPS1216 .....	35
BLPSM1413 .....	22	BLPSMIM1213 .....	96	BLPSPS1221 .....	35
BLPSM1414 .....	22	BLPSMIM1214 .....	96	BLPSPS1258 .....	35
BLPSM3810 .....	27	BLPSMIM1215 .....	96	BLPSPS3816 .....	29
BLPSM3811 .....	27	BLPSMIM1216 .....	96	BLPSPS3821 .....	29
BLPSM3812 .....	27	BLPSMIM1217 .....	96	BLPSPS3858 .....	29
BLPSM3813 .....	27	BLPSMIM1218 .....	96	BLPSPS121316 .....	35
BLPSM3814 .....	27	BLPSMIM1219 .....	96	BLPSPS381316 .....	29
BLPSM3815 .....	27	BLPSMIM1221 .....	96	BLPSQB1 .....	53
BLPSM3816 .....	27	BLPSMIM1222 .....	96	BLPSQB2 .....	53
BLPSM3817 .....	27	BLPSMIM1223 .....	96	BLPSTHD144 .....	24
BLPSM3818 .....	27	BLPSMIM1224 .....	96	BLPSTHD388 .....	30
BLPSM3819 .....	27	BLPSMIM1227 .....	96	BLPSTHD1215 .....	35
BLPSM3820 .....	27	BLPSMIM1229 .....	96	BLPSTHD3418 .....	37
BLPSM3821 .....	27	BLPSMIM1230 .....	96	BLPSTWR4 .....	47
BLPSM3822 .....	27	BLPSMIM1232 .....	96	BLPSTWR6 .....	47
BLPSM3823 .....	27	BLPSMIM3417 .....	98	BLPT146TP .....	26
BLPSM3824 .....	27	BLPSMIM3418 .....	98	BLPT147TP .....	26
BLPSMIM117 .....	100	BLPSMIM3419 .....	98	BLPT148TP .....	26
BLPSMIM118 .....	100	BLPSMIM3420 .....	98	BLPT149TP .....	26
BLPSMIM119 .....	100	BLPSMIM3421 .....	98	BLPT1220 .....	36
BLPSMIM120 .....	100	BLPSMIM3422 .....	98	BLPT1225 .....	36
BLPSMIM121 .....	100	BLPSMIM3423 .....	98	BLPT1227 .....	36
BLPSMIM122 .....	100	BLPSMIM3424 .....	98	BLPT1230 .....	36
BLPSMIM123 .....	100	BLPSMIM3425 .....	98	BLPT1240 .....	36
BLPSMIM124 .....	100	BLPSMIM3426 .....	98	BLPT1245 .....	36
BLPSMIM125 .....	100	BLPSMIM3427 .....	98	BLPT1250 .....	36
BLPSMIM126 .....	100	BLPSMIM3428 .....	98	BLPT1255 .....	36
BLPSMIM127 .....	100	BLPSMIM3429 .....	98	BLPT1255TP .....	34



**WARNING**



• Do not exceed capacity of jacks or jack stands • Do not work on vehicles supported by jack, use jack stands  
 • Use jack and jack stands only on hard level surfaces • Read safety precautions on page 162

BLPT1260 .....	36
BLPT1260TP .....	34
BLPT1410TP .....	26
BLPT1415TP .....	26
BLPT1420TP .....	26
BLPT1425TP .....	26
BLPT1427TP .....	26
BLPT1430TP .....	26
BLPT3810TP .....	31
BLPT3815TP .....	31
BLPT3820TP .....	31
BLPT3825TP .....	31
BLPT3827TP .....	31
BLPT3830TP .....	31
BLPT3840TP .....	31
BLPT3845TP .....	31
BLPT3850TP .....	31
BLPT3855TP .....	31
BLPTB10TP .....	53
BLPTB15TP .....	53
BLPTB20TP .....	53
BLPTB25TP .....	53
BLPTB30TP .....	53
BLPTE144 .....	23
BLPTE145 .....	23
BLPTE146 .....	23
BLPTE147 .....	23
BLPTE148 .....	23
BLPTE384 .....	28
BLPTE385 .....	28
BLPTE386 .....	28
BLPTE387 .....	28
BLPTE388 .....	28
BLPTE1210 .....	34
BLPTE1212 .....	34
BLPTE1214 .....	34
BLPTE1216 .....	34
BLPTE1218 .....	34
BLPTE1220 .....	34
BLPTE1222 .....	34
BLPTE1224 .....	34
BLPTE3810 .....	28
BLPTE3811 .....	28
BLPTE3812 .....	28
BLPTE3814 .....	28
BLPTE3816 .....	28
BLPTE3818 .....	28
BLPTE3820 .....	28
BLPTHSM0142 .....	25
BLPTHSM0143 .....	25
BLPTHSM0144 .....	25
BLPTHSM0145 .....	25
BLPTHSM0146 .....	25
BLPTHSM0147 .....	25
BLPTHSM0148 .....	25
BLPTHSM0149 .....	25
BLPTHSM01410 .....	25
BLPTHSM01425 .....	25
BLPTL1220 .....	36
BLPTL1225 .....	36
BLPTL1227 .....	36
BLPTL1230 .....	36
BLPTL1240 .....	36
BLPTL1245 .....	36
BLPTL1250 .....	36
BLPTL1255 .....	36
BLPTL1260 .....	36
BLPTMBS1414 .....	25
BLPTMBS3814 .....	31
BLPTS0148 .....	25
BLPTS01410 .....	25
BLPTS01415 .....	25
BLPTS01420 .....	25

BLPTS01425 .....	25
BLPTS01427 .....	25
BLPTS01430 .....	25
BLPTS01440 .....	25
BLPTS01445 .....	25
BLPTS01447 .....	25
BLPTS01450 .....	25
BLPTS3810 .....	31
BLPTS3815 .....	31
BLPTS3820 .....	31
BLPTS3825 .....	31
BLPTS3827 .....	31
BLPTS3830 .....	31
BLPTS3840 .....	31
BLPTS3845 .....	31
BLPTS3850 .....	31
BLPTS3855 .....	31
BLPTS3860 .....	31
BLPTSSC43 .....	11
BLPTXK1.5 .....	24
BLPTXK2 .....	24
BLPTXK3 .....	24
BLPTXK4 .....	24
BLPTXK6 .....	24
BLPUJ12 .....	35
BLPUJ14 .....	25
BLPUJ34 .....	37
BLPUJ38 .....	29
BLPXZN144 .....	26
BLPXZN145 .....	26
BLPXZN146 .....	26
BLPXZN148 .....	26
BLPXZN1410 .....	26
BLPXZN1412 .....	26
BLPXZNM125 .....	36
BLPXZNM126 .....	36
BLPXZNM128 .....	36
BLPXZNM0384 .....	32
BLPXZNM0385 .....	32
BLPXZNM0386 .....	32
BLPXZNM0388 .....	32
BLPXZNM1210 .....	36
BLPXZNM1212 .....	36
BLPXZNM1214 .....	36
BLPXZNM1216 .....	36
BLPXZNM03810 .....	32
BLPXZNM03812 .....	32
BLWM1.5 .....	42
BLWM2 .....	42
BLWM2.5 .....	42
BLWM3 .....	42
BLWM4 .....	42
BLWM5 .....	42
BLWM6 .....	42
BLWM8 .....	42
BLWM10 .....	42
BLWM11 .....	47
BLWM12 .....	47
BLWM13 .....	47
BLWM14 .....	47
BLWM15 .....	47
BLWM16 .....	47
BLWM17 .....	47
BLWM18 .....	47
BLWM19 .....	47
BLWSM9 .....	42
BLWTS9 .....	42
BMPECSAP .....	56
BMPL1000 .....	56
BMPLM3 .....	119
BMPLM5 .....	119
BMPM3 .....	119
BMPM5 .....	119

BMPM8 .....	119
BOER8 .....	44
BOER10 .....	40
BOER12 .....	40
BOER14 .....	40
BOER16 .....	40
BOER18 .....	40
BOER20 .....	40
BOER22 .....	40
BOER24 .....	40
BOER26 .....	40
BOER28 .....	40
BOER30 .....	40
BOER32 .....	40
BOER704 .....	40
BOER708 .....	40
BOERF10A .....	41
BOERF12A .....	41
BOERF14A .....	41
BOERF16A .....	41
BOERF18A .....	41
BOERF20A .....	41
BOERF22A .....	41
BOERF24A .....	41
BOERF708A .....	41
BOERFLCG10 .....	42
BOERFLCG12 .....	42
BOERFLCG14 .....	42
BOERFLCG16 .....	42
BOERFLCG18 .....	42
BOERFLCG20 .....	42
BOERFLCG22 .....	42
BOERFLCG24 .....	42
BOERFLCG708 .....	42
BOERM6 .....	44
BOERM7 .....	44
BOERM8 .....	40
BOERM9 .....	40
BOERM10 .....	40
BOERM11 .....	40
BOERM12 .....	40
BOERM13 .....	40
BOERM14 .....	40
BOERM15 .....	40
BOERM16 .....	40
BOERM17 .....	40
BOERM18 .....	40
BOERM19 .....	40
BOERM21 .....	40
BOERM22 .....	40
BOERM24 .....	40
BOERM25 .....	40
BOERM704 .....	40
BOERM712 .....	40
BOERMF8A .....	41
BOERMF9A .....	41
BOERMF10A .....	41
BOERMF11A .....	41
BOERMF12A .....	41
BOERMF13A .....	41
BOERMF14A .....	41
BOERMF15A .....	41
BOERMF16A .....	41
BOERMF17A .....	41
BOERMF18A .....	41
BOERMF19A .....	41
BOERMF712A .....	41
BOERMFLCG8 .....	41
BOERMFLCG9 .....	41
BOERMFLCG10 .....	41
BOERMFLCG11 .....	41
BOERMFLCG12 .....	41
BOERMFLCG13 .....	41

BOERMFLCG14 .....	41	BP602NMRMH .....	72	BSGD75S3B .....	50
BOERMFLCG15 .....	41	BP1001-O-DTT .....	75	BSGD75S3R .....	50
BOERMFLCG16 .....	41	BP1002CF3 .....	74	BSGD75S3Y .....	50
BOERMFLCG17 .....	41	BP1002NMRMH .....	72	BSGD100PH0B .....	50
BOERMFLCG18 .....	41	BP2003NMRMH .....	72	BSGD100PH0R .....	50
BOERMFLCG19 .....	41	BP2401CI3 .....	74	BSGD100PH0Y .....	50
BOERMFLCG712 .....	41	BP2502-I-DTT .....	75	BSGD100PH1B .....	50
BOERMS8 .....	41	BP2502NMRMH .....	72	BSGD100PH1R .....	50
BOERMS9 .....	41	BP2503CF3 .....	74	BSGD100PH1Y .....	50
BOERMS10 .....	41	BP2503-F-DTT .....	75	BSGD100PH2B .....	50
BOERMS11 .....	41	BP3403NMRMH .....	72	BSGD100PH2R .....	50
BOERMS12 .....	41	BP6004-F-DTT .....	75	BSGD100PH2Y .....	50
BOERMS13 .....	41	BP8004NMRMH .....	72	BSGD100S4B .....	50
BOERMS14 .....	41	BP15005NMRMH .....	72	BSGD100S4R .....	50
BOERMS15 .....	41	BPAP1 .....	129	BSGD100S4Y .....	50
BOERMS16 .....	41	BPAP2 .....	129	BSGD125F5B .....	50
BOERMS17 .....	41	BPAPS1 .....	129	BSGD125F5R .....	50
BOERMS18 .....	41	BPB4 .....	108	BSGD125F5Y .....	50
BOERMS19 .....	41	BPB8 .....	108	BSGD125F6B .....	50
BOERMS712 .....	41	BPB12 .....	108	BSGD125F6R .....	50
BOERMSF8 .....	46	BPB16 .....	108	BSGD125F6Y .....	50
BOERMSF9 .....	46	BPB24 .....	108	BSGD125S4B .....	50
BOERMSF10 .....	46	BPB32 .....	108	BSGD125S4R .....	50
BOERMSF11 .....	46	BPB40 .....	108	BSGD125S4Y .....	50
BOERMSF12 .....	46	BPB48 .....	108	BSGD125S5B .....	50
BOERMSF13 .....	46	BPBOX18 .....	6	BSGD125S5R .....	50
BOERMSF14 .....	46	BPBOX20 .....	6	BSGD125S5Y .....	50
BOERMSF15 .....	46	BPC6 .....	61	BSGD150F6B .....	50
BOERMSF16 .....	46	BPECT1 .....	137	BSGD150F6R .....	50
BOERMSF17 .....	46	BPL501 .....	56	BSGD150F6Y .....	50
BOERMSF18 .....	46	BPN8B .....	108	BSGD150F8B .....	50
BOERMSF19 .....	46	BPN12B .....	108	BSGD150F8R .....	50
BOERS10 .....	41	BPN16B .....	108	BSGD150F8Y .....	50
BOERS12 .....	41	BPN24B .....	108	BSGD150PH0B .....	50
BOERS14 .....	41	BPN32B .....	108	BSGD150PH0R .....	50
BOERS16 .....	41	BPRFPT10 .....	32	BSGD150PH0Y .....	50
BOERS18 .....	41	BPRFR938 .....	28	BSGD150PH1B .....	50
BOERS20 .....	41	BPRFR938SG .....	28	BSGD150PH1R .....	50
BOERS22 .....	41	BPRSR940 .....	34	BSGD150PH1Y .....	50
BOERS24 .....	41	BPRSR940SG .....	35	BSGD150PH2B .....	50
BOERS708 .....	41	BPRSR942 .....	34	BSGD150PH2R .....	50
BOERSF10 .....	41	BPRT936 .....	23	BSGD150PH2Y .....	50
BOERSF12 .....	41	BPRT936SG .....	23	BSGD150PH3B .....	50
BOERSF14 .....	41	BPS1 .....	17	BSGD150PH3R .....	50
BOERSF16 .....	41	BPS2 .....	17	BSGD150PH3Y .....	50
BOERSF18 .....	41	BPS3 .....	17	BSGD150S4B .....	50
BOERSF20 .....	41	BPS4P .....	17	BSGD150S4R .....	50
BOERSF22 .....	41	BPS5 .....	17	BSGD150S4Y .....	50
BOERSF24 .....	41	BPS6 .....	17	BSGD150S5B .....	50
BOERSF708 .....	41	BPS6A .....	17	BSGD150S5R .....	50
BP5T-1R .....	72	BPS7 .....	18	BSGD150S5Y .....	50
BP5T-I .....	73	BPS8 .....	18	BSGD175F8B .....	50
BP10002-I-DTT .....	75	BPS9 .....	18	BSGD175F8R .....	50
BP10ST-I .....	73	BPS10 .....	18	BSGD175F8Y .....	50
BP10T-2R .....	72	BPS11 .....	19	BSGD200PH1B .....	50
BP10T-2RL .....	72	BPS12 .....	19	BSGD200PH1R .....	50
BP10T-I .....	73	BPS13 .....	19	BSGD200PH1Y .....	50
BP50T-2R .....	72	BPS14 .....	19	BSGD200PH2B .....	50
BP50T-2RL .....	72	BPTHM08 .....	47	BSGD200PH2R .....	50
BP50T-I .....	73	BPTHM09 .....	47	BSGD200PH2Y .....	50
BP100T-3R .....	72	BPTHM10 .....	47	BSGD200PH3B .....	50
BP100T-3RL .....	72	BPTHM11 .....	47	BSGD200PH3R .....	50
BP100T-I .....	73	BPTHM12 .....	47	BSGD200PH3Y .....	50
BP200T-3R .....	72	BPTHM13 .....	47	BSGD250F6B .....	50
BP200T-3RL .....	72	BPTHM14 .....	47	BSGD250F6R .....	50
BP200T-I .....	73	BPTOTE .....	6	BSGD250F6Y .....	50
BP250T-3RL .....	72	BPWORKBENCH .....	161	BSGD250PH1B .....	50
BP300T-4R .....	72	BSGD75F4B .....	50	BSGD250PH1R .....	50
BP300T-I .....	73	BSGD75F4R .....	50	BSGD250PH1Y .....	50
BP501-I-DTT .....	75	BSGD75F4Y .....	50	BSGD250PH2B .....	50
BP501NMRMH .....	72	BSGD75PH0B .....	50	BSGD250PH2R .....	50
BP600T-4R .....	72	BSGD75PH0R .....	50	BSGD250PH2Y .....	50
BP600T-I* .....	73	BSGD75PH0Y .....	50	BSGD250S4B .....	50



BSGD250S4R .....	50
BSGD250S4Y .....	50
BSGD300PH1B .....	50
BSGD300PH1R .....	50
BSGD300PH1Y .....	50
BSGD300PH2B .....	50
BSGD300PH2R .....	50
BSGD300PH2Y .....	50
BSGDM38F6 .....	52
BSGDM38PH2 .....	52
BSGDM38PZ2 .....	52
BSGDM65F2 .....	52
BSGDM65PH00 .....	52
BSGDM65PZ00 .....	52
BSGDM75F3 .....	52
BSGDM75F5 .....	52
BSGDM75PH0 .....	52
BSGDM75PH1 .....	52
BSGDM75PZ0 .....	52
BSGDM75PZ1 .....	52
BSGDM75TX6 .....	52
BSGDM75TX7 .....	52
BSGDM75TX8 .....	52
BSGDM75TX9 .....	52
BSGDM100F3 .....	52
BSGDM100F5 .....	52
BSGDM100F6 .....	52
BSGDM100PH0 .....	52
BSGDM100PH1 .....	52
BSGDM100PH2 .....	52
BSGDM100PZ0 .....	52
BSGDM100PZ1 .....	52
BSGDM100PZ2 .....	52
BSGDM100TX10 .....	52
BSGDM100TX15 .....	52
BSGDM100TX20 .....	52
BSGDM100TX25 .....	52
BSGDM100TX27 .....	52
BSGDM100TX30 .....	52
BSGDM100TX40 .....	52
BSGDM150F3 .....	52
BSGDM150F5 .....	52
BSGDM150F6 .....	52
BSGDM150F8 .....	52
BSGDM150PH0 .....	52
BSGDM150PH1 .....	52
BSGDM150PH2 .....	52
BSGDM150PH3 .....	52
BSGDM150PZ0 .....	52
BSGDM150PZ1 .....	52
BSGDM150PZ2 .....	52
BSGDM150PZ3 .....	52
BSGDM200F5 .....	52
BSGDM200F6 .....	52
BSGDM200F8 .....	52
BSGDM200F9 .....	52
BSGDM200PH2 .....	52
BSGDM200PH3 .....	52
BSGDM200PH4 .....	52
BSGDM200PZ2 .....	52
BSGDM200PZ3 .....	52
BSGDM200PZ4 .....	52
BSGDM250F6 .....	52
BSGDM250PH2 .....	52
BSGDM250PZ2 .....	52
BSGDV100PH0 .....	51
BSGDV100S2 .....	51
BSGDV100S3 .....	51
BSGDV100S4 .....	51
BSGDV125S5 .....	51
BSGDV150PH1 .....	51
BSGDV150S6 .....	51
BSGDV175PH2 .....	51

BSGDV200PH3 .....	51
BSP6 .....	60
BT9 .....	155
BTC3A .....	142
BTCP1 .....	155
BTG8 .....	155
BTQS500 .....	148
BTQS600 .....	149
BTQS1000 .....	149
BTWM1.5 .....	47
BTWM2.5 .....	47
BTWM3 .....	47
BTWM4 .....	47
BTWM5 .....	47
BTWM6 .....	47
BTWM7 .....	47
BTWM8 .....	47

### C

CD7A .....	112
CD10A .....	112
CD12A .....	112
CD16A .....	112
CF19B .....	153
CF700B .....	153
CF811B .....	153
CL404VIS .....	128
CL406VIS .....	128
CL408VIS .....	128
CM6416 .....	128
CNT6521 .....	120
CW12A .....	47
CW15A .....	47
CW24A .....	47

### D

DBBP21 .....	104
DBBPC21 .....	104
DBBPT13 .....	104
DEBUR300 .....	128
DG530 .....	136
DM6 .....	121
DM61 .....	121
DM62 .....	121
DM63 .....	121
DM64 .....	121
DM65 .....	121
DM66 .....	121
DM67 .....	121
DPFT528B .....	110

### E

E1020 .....	137
E1025 .....	137
ECF201A .....	122
ECF1600 .....	122
ECFB200BL .....	122
ECFB200S .....	122
ECFBP20AP .....	124
ECFHEAD1A .....	124
ECFLED24 .....	124
ECFLED215AP .....	123
ECFLOODAP .....	124
ECFPKT20AP .....	123
ECFUVLITE .....	143
ECUB9500AP .....	122
EECS1AP .....	142
EEFB310 .....	138
EEFB315 .....	138
EELDGASCAP1 .....	140

ETA125A .....	102
ETB14401A .....	94
ETB14410A .....	93
ETB14419A .....	94
ETB14420A .....	93
ETB14430A .....	94
ETB14438A .....	93
ETB14460A .....	93

### F

FB300A .....	118
FB307D .....	119
FB308D .....	118
FB310B .....	118
FB316B .....	118
FB322 .....	119
FB325A .....	118
FB326B .....	118
FB328A .....	119
FB335 .....	118
FBL325A .....	118
FBM320 .....	118
FBM322 .....	118
FB55 .....	136
FSD1 .....	28
FSD14 .....	23
FSD38 .....	23
FSDR .....	23
FSDR1 .....	28
FUNN15 .....	151
FW7630A .....	151
FW656714A .....	151
FW757715A .....	151
FWA62121A .....	151
FWK7A .....	151
FXLBP3 .....	30
FXLBP6 .....	30
FXLBP10 .....	30

### G

GA225 .....	125
GA395 .....	136
GA472 .....	151
GA541 .....	137
GA599A .....	148
GA3200 .....	125
GAJ4A .....	42
GAJ4AP .....	42
GAJ6A .....	42
GAJ6AP .....	42
GAJ6SG .....	43
GAJ6SGAP .....	43
GAJ8A .....	42
GAJ8AP .....	42
GAJ8SG .....	43
GAJ8SGAP .....	43
GAJ10A .....	42
GAJ10AP .....	42
GAJ10SG .....	43
GAJ10SGAP .....	43
GAJ12A .....	42
GAJ12AP .....	42
GAJ12SG .....	43
GAJ12SGAP .....	43
GAJ15A .....	42
GAJ15AP .....	42
GAJ18A .....	42
GAJ18AP .....	42
GAJ24A .....	42
GAJ24AP .....	42
GAJS30A .....	42



GAJS30AP .....	42
GAM541 .....	137
GDCT16 .....	146
GLASS30BK .....	125
GLASS30R .....	125
GLASS31BK .....	125
GLASS31R .....	125
GLOVE103LA .....	124
GLOVE103LAB .....	124
GLOVE103MA .....	124
GLOVE103MAB .....	124
GLOVE103XLA .....	124
GLOVE103XLAB .....	124
GLOVE400L .....	124
GLOVE400M .....	124
GLOVE400S .....	124
GLOVE400XL .....	124
GLOVE400XXL .....	124

### H

HBR15 .....	110
HBR25 .....	110
HCP3KT .....	142
HD45G .....	110
HDSCISSORS .....	113
HP2 .....	127
HP301C .....	155
HP650 .....	157
HP650M .....	157
HRC1300380 .....	129
HRC1401340 .....	129
HRC1502170 .....	129
HRC1502171 .....	129
HRC1502172 .....	129
HRC1502173 .....	129
HRC1502174 .....	129
HRC1600840 .....	129
HRC1600850 .....	129
HRC1600860 .....	129
HRC1600870 .....	129
HRC1600880 .....	129
HRC1600890 .....	129
HRC1800710 .....	129
HRC4300557 .....	129
HRC4301650 .....	129
HRC4304482 .....	129
HRC9000160 .....	129
HRC9004484 .....	129
HRC9004486 .....	129
HRC9100614 .....	129

### J

JCW8A .....	154
JT13B .....	104

### K

KRB17 .....	4
KRB24 .....	4
KRB2006KPQP .....	2
KRB2006KPQR .....	2
KRB2055KPQP .....	3
KRB2055KPQR .....	3
KRB13005KPRB .....	2
KRB13005KPRR .....	2
KRB13006KPRB .....	2
KRB13006KPRR .....	2
KRB13007KPRB .....	3
KRB13007KPRR .....	3
KRB13008KPRB .....	2
KRB13008KPRR .....	2

KRBC2TC .....	3
KRBC2TCPCM .....	3
KRBC3TD .....	3
KRBC3TDPCM .....	3
KRBC7TD .....	3
KRBC7TDPCM .....	3
KRBC10TB .....	3
KRBC10TBPCM .....	3
KRBC15T .....	4
KRBC15TPCM .....	4
KRBC15TPCMTC .....	4
KRBCSST .....	4
KRBCSSTPCM .....	4
KRU24B .....	5
KRW48C .....	4
KRW182B .....	5
KRW183C .....	5
KRW184B .....	5

### L

LBUK1 .....	113
LDT8 .....	142
LDT14 .....	142
LOS145A .....	157
LSR1000A .....	149

### M

MAGWRENCH .....	135
MCAL6A .....	120
MCAL12A .....	120
MIC1B .....	121
MIC1MB .....	121
MIC2B .....	121
MIC2MB .....	121
MIC3B .....	121
MIC3MB .....	121
MIC4B .....	121
MIC4MB .....	121
MIC5B .....	121
MIC5MB .....	121
MIC103B .....	121
MIC103MB .....	121
MICB1B .....	121
MICB2B .....	121
MICB3B .....	121
MICB4B .....	121
MICB5B .....	121
MICB103B .....	121
MICED1B .....	121
MICINSIDE12 .....	121
MIGCARTA .....	161
ML6000COMBO .....	150
MRB5A .....	134
MRB10A .....	134
MRB12A .....	134
MRB15A .....	134
MSC1 .....	150
MSC2 .....	150
MT454C .....	139
MT501C .....	139
MT574C .....	139
MTPV1000 .....	139

### N

NOZZLE360A .....	127
------------------	-----

### P

PBFG415 .....	134
PHT5 .....	126

PK23A .....	111
PK50A .....	111
PK52A .....	111
PK53A .....	111
PK500A .....	111
PKB50A .....	111
PKB52A .....	111
PKB53A .....	111
PKB500A .....	111
PKWLR53A .....	111
PKWSS53A .....	111
PMF147A .....	120
POLISHW8A .....	103
PR7 .....	69
PR7-1 .....	69
PR7-3 .....	69
PR8 .....	69
PR36 .....	58
PR37 .....	58
PR38 .....	58
PR50A .....	58
PR51 .....	58
PR52 .....	58
PR53 .....	69
PR53-1 .....	69
PR53-3 .....	69
PR54 .....	69
PR54-1 .....	69
PR54-3 .....	69
PRC65A .....	58
PRH56A .....	58
PRH57A .....	58
PRH502A .....	58
PRH503 .....	58
PSLR4 .....	133
PSLR4-1 .....	133
PSLR4-2 .....	133
PSLR4-3 .....	133
PSLR4-4 .....	133
PSLR4-5 .....	133
PSLR4-6 .....	133
PSLR6 .....	133
PT5C .....	126
PT5CBL .....	126
PWC6 .....	133
PWC12A .....	133
PWC14 .....	133
PWC19 .....	134
PWC27 .....	133
PWC28A .....	133
PWC34 .....	134
PWC60 .....	147
PWC80A .....	136

### Q

QJD8A-72 .....	73
QJD12A .....	73
QJD16A .....	73
QJOM6A .....	73
QJOM7A .....	73
QJOM8A .....	73
QJOM9A .....	73
QJOM10A .....	73
QJOM11A .....	73
QJOM12A .....	73
QJOM13A .....	73
QJOM14A .....	73
QJOM15A .....	73
QJOM16A .....	73
QJOM17A .....	73
QJOM18A .....	73
QJOM19A .....	73



WARNING



• Do not exceed capacity of jacks or jack stands • Do not work on vehicles supported by jack, use jack stands  
• Use jack and jack stands only on hard level surfaces • Read safety precautions on page 162

QJOM21A	73
QJOM22A	73
QJOM23A	73
QJOM24A	73
QJOM25A	73
QJOM26A	73
QJOM27A	73
QXD16A	73
QXD24A	73
QXD32A	73
QXOM18A	73
QXOM19A	73
QXOM20A	73
QXOM21A	73
QXOM22A	73
QXOM23A	73
QXOM24A	73
QXOM26A	73
QXOM29A	73
QXOM30A	73
QXOM32A	73
QXOM34A	73
QXOM36A	73
QYD12A	73
QYD16A	73
QYOM14A	73
QYOM15A	73
QYOM16A	73
QYOM17A	73
QYOM18A	73
QYOM19A	73
QYOM20A	73
QYOM21A	73
QYOM22A	73
QYOM23A	73
QYOM24A	73
QYOM25A	73
QYOM27A	73
QYOM29A	73
QYOM30A	73
QYOM32A	73
QYOM34A	73
QYOM36A	73
QZD24B	73
QZD32B	73
QZOM24A	73
QZOM25A	73
QZOM26A	73
QZOM27A	73
QZOM29A	73
QZOM30A	73
QZOM32A	73
QZOM34A	73
QZOM36A	73

### R

RBZ605	42
RBZ810	42
RBZ1214	42
RBZ1618	42
RBZ2022	47
RBZ2428	47
RBZM78	47
RBZM605	42
RBZM910	42
RBZM1112	42
RBZM1314	42
RBZM1517	42
RBZM1618	47
RBZM1921	47
RC40C	154
RC50C	154

RC980	154
RM130	154
RTEMPB3A	141
RULER12BSQ	120

### S

SBT26	153
SDM11KT	135
SDM32KT	135
SKRSST4107	7
SKRWT4008	7
SKRWT4800B	7
SNP2A	112
SQUAREB12	120
SQUAREB45	120
SQUAREB90	120
SQUAREB180	120
SQUARECOMB12	120
SVT275	147
SVTAB1400	146
SXLBP3	35
SXLBP6	35
SXLBP10	35

### T

T10	42
T15	42
T20	42
T25	42
T27	42
T30	42
T40	42
T45	42
T50	42
TBS200A	136
TC28B1	115
TC28C	115
TC123C	115
TC123C1	115
TC123CR	115
TC123CRH	115
TEMP10	144
TF5A	114
TF275A	114
TF528D	115
TFM5A	114
TFM428	115
TIF160	147
TL100A	119
TLT5	140
TLT6	140
TLT7	140
TLT8000	140
TLT8003	140
TPGDL1000A	147
TPGIF1600	148
TPGP120	148
TPM100	119
TT12KT	141
TZK5	133
TZK7	133

### U

UIM125	127
UIM225	127
UIM325	127
UKBU10	114
UKBU50PK	114
UPT2FL	127
UPT15	126

UPT35	127
UPT50A	127
UPT65	127
US710	111
US711	111
US712	111
USS103	111

### V

VAC201	150
VGP12406	68
VGP12412	68
VGP12418	68
VGP12424	68
VGP12509	68
VGP12808	69
VGP18110	68
VGP22406	68
VGP22412	68
VGP22418	68
VGP22424	68
VT1A	148
VT14	148

### W

WE200A	129
WE200A1	129
WE200A2	129
WT1001-6	67
WT1001-8	67
WT1003-6	67
WT1014-6	67
WT1014-7	67
WT1014-8	67
WT1017C-6	67
WT5403-8	67
WT5414-9	67
WT8627-10	67

### Y

YA12AP	161
YA52PBSQC	134
YA109C	156
YA160A	125
YA261A	102
YA262A	102
YA263A	102
YA328A	119
YA427B	125
YA444B	112
YA444B1	112
YA481	6
YA482	6
YA483	6
YA484	6
YA486	6
YA512	160
YA580A	113
YA580A-1	113
YA581A	113
YA581A-1	113
YA714D	160
YA728A	151
YA734A	152
YA745A	152
YA750	152
YA751	152
YA752	152
YA772B	152
YA801	152

YA824ASTR .....	138
YA824C .....	138
YA874BP .....	160
YA879A .....	110
YA900 .....	110
YA1050B .....	104
YA1055B .....	135
YA1228 .....	161
YA1544A .....	137
YA1707 .....	160
YA1715 .....	160
YA2440 .....	136
YA2612B .....	142
YA3000C .....	149
YA3100 .....	149
YA3202 .....	138
YA3500 .....	149
YA4000B .....	156
YA4274 .....	150
YA4275 .....	151
YA4280 .....	125
YA4282 .....	125
YA4603 .....	128
YA5100B .....	122
YA6160 .....	147
YA6910 .....	141
YA7500 .....	152
YA8005 .....	138
YA8230 .....	154
YA8610B .....	155
YA9329A .....	136
YA9350B .....	153
YA76462 .....	141
YA76562 .....	141
YA105020 .....	135
YAS203A .....	102
YB2AP .....	161
YB3AP .....	161
YB5AP .....	161
YF2AP .....	160
YF3AP .....	160





Blue-Point, No Compromise!



